



# **CARLISLE**

FOODSERVICE PRODUCTS  
2019-2020

# CFS BRANDS®

**THE LEADER IN**

FoodService Healthcare Janitorial

CFS Brands unites the leading names in foodservice, healthcare and janitorial.

CFS Brands is building the leading platform for light equipment and supplies – bringing professional-grade product solutions to customers around the globe. Our companies include Carlisle FoodService Products, San Jamar, Dinex, Sparta Brush, Marko, Snap Drape and others.

SERVE  
**PREPARE**  
PROTECT  
**DELIVER**  
DISPENSE  
**CLEAN**



# CATALOG GUIDE

	Dinnerware.....	<b>6-33</b>
	Drinkware.....	<b>34-53</b>
	Tabletop Accessories .....	<b>54-67</b>
	Marko.....	<b>68-77</b>
	Displayware .....	<b>78-105</b>
	Food Bars & Convenience...	<b>106-133</b>
	Bar Supplies.....	<b>134-147</b>
	Foodservice Trays.....	<b>148-165</b>
	Catering Equipment .....	<b>166-179</b>
	Professional Cookware .....	<b>180-191</b>
	Kitchen Accessories .....	<b>192-213</b>
	Storage & Handling .....	<b>214-233</b>
	Warewashing .....	<b>234-253</b>
	Cleaning Tools.....	<b>254-275</b>
	Floor & Restroom Care.....	<b>276-311</b>
	Transportation .....	<b>312-321</b>
	Waste Management .....	<b>322-333</b>
	Reference/Index/ Terms & Conditions .....	<b>334-345</b>

## Category Symbols



Front of House



Back of House



Sanitary Maintenance



Reference



Index

## PROP 65 WARNINGS

### APPENDIX A – Bisphenol A (BPA)

 **WARNING:** This product can expose you to chemicals including Bisphenol A (BPA), which is known to the State of California to cause birth defects or other reproductive harm.

For more information go to [www.P65Warnings.ca.gov](http://www.P65Warnings.ca.gov).

### APPENDIX B – Di(2-ethylhexylphthalate) (DEHP)

 **WARNING:** This product can expose you to chemicals including Di(2-ethylhexyl)phthalate (DEHP), which is known to the State of California to cause birth defects or other reproductive harm.

For more information go to [www.P65Warnings.ca.gov](http://www.P65Warnings.ca.gov).

### APPENDIX C – Styrene

 **WARNING:** This product can expose you to chemicals including Styrene, which is known to the State of California to cause birth defects or other reproductive harm.

For more information go to [www.P65Warnings.ca.gov](http://www.P65Warnings.ca.gov).

<b>PRODUCT</b>	<b>PAGE</b>	<b>PRODUCT</b>	<b>PAGE</b>	<b>PRODUCT</b>	<b>PAGE</b>
21 Key Brushes . . . . .	257-259	Grove . . . . .	12	Hand & Nail . . . . .	270
Adapter Bars . . . . .	225	Halcyon . . . . .	10	Handle Guide . . . . .	275
Bains Marie . . . . .	232	Leaf . . . . .	29, 96	High Temp . . . . .	262
Bakeware		Melamine Bowls . . . . .	30	Hot Dog Roller . . . . .	262
Bake Pans . . . . .	188, 190	Microwave-Ware . . . . .	31	Iron Handle . . . . .	265
Cupcake Pans . . . . .	190	Mingle . . . . .	11	Meat Slicer Cleaner . . . . .	266
Icing Grates . . . . .	191	Mixing . . . . .	209	Oven & Grill . . . . .	268
Muffin Pans . . . . .	190	Octagon . . . . .	92	Pastry . . . . .	200-202
Pullman Pans . . . . .	190	Orchid Deli . . . . .	91	Potato . . . . .	203
Loaf Pans . . . . .	190	Palette Designer Displayware . . . . .	84-85	Racks . . . . .	296
Roast Pans . . . . .	188-189	Palette Displayware Covers . . . . .	85	Radiator . . . . .	273
Sheet Pans . . . . .	191	Pebbled . . . . .	97	Scratch . . . . .	269
Bar Accessories . . . . .	142-147	Petal Mist . . . . .	29, 95	Spouts, Pumps & Valves . . . . .	263
Bar Caddy . . . . .	142	Punch . . . . .	104	Tile & GROUT . . . . .	289
Bar Mat & Service Mat . . . . .	143	Rave Displayware . . . . .	82	Toilet Bowl Brush . . . . .	309
Bar & Shelf Liner . . . . .	143	Roll-Top Covered . . . . .	66	Toothbrush Style . . . . .	266
Barware		Salad . . . . .	30, 87	Utility Scrubs . . . . .	271
Alibi . . . . .	36-37	Salsa . . . . .	58	Vegetable . . . . .	203
Lexington Mug . . . . .	48	Scoop . . . . .	90	Vegetable Cutter . . . . .	265
Liberty . . . . .	44	Soup . . . . .	31	Wok . . . . .	264
Mingle . . . . .	38	Stack . . . . .	96	Bud Vases . . . . .	61
Baskets		Brooms		Burger Cover . . . . .	187
Basket Server . . . . .	62	Angle . . . . .	278	Bus Boxes & Lids . . . . .	252-253
Bread & Bun Basket . . . . .	63	Duo-Sweep . . . . .	278-279	Caddies, Condiment & Bar . . . . .	131, 141
Munchie Baskets . . . . .	62	Dust Pans . . . . .	286	Cake Covers & Tray . . . . .	99
WeaveWear Baskets & Platter . . . . .	63	Floor Sweepers . . . . .	286	Carts	
Wicker Look Basket . . . . .	63	Handle Guide . . . . .	275	Bussing/Transport . . . . .	316
Woven Baskets . . . . .	62	Lobby Pans . . . . .	286	Dish Dollies . . . . .	319-320
Basting Brushes . . . . .	200-202	Lobby Pans & Broom Combos . . . . .	285	Fold 'N Go Carts . . . . .	314-315
Beverage Dispensers/Servers		Natural Corn & Blend . . . . .	280	Janitorial Carts . . . . .	321
Cateraide IT . . . . .	170	Racks . . . . .	296	Service Carts . . . . .	317
Cateraide LD Series Insulated . . . . .	175	Recycled . . . . .	278	Stainless Steel Carts . . . . .	317
Cateraide Slide 'N Seal Insulated . . . . .	172	Straight . . . . .	279	Utility Carts . . . . .	318
Cateraide XT Series Insulated . . . . .	174	Synthetic Corn . . . . .	281	Carafes	
Round Beverage Dispenser . . . . .	132	Brushes & Scrubs		2 Cup . . . . .	47
Square Beverage Dispenser . . . . .	132	Atlas Multi-Purpose . . . . .	260	Cascata . . . . .	47
TrimLine Rectangular . . . . .	132	Bake Pan Lip . . . . .	265	Charger Plates . . . . .	30
Bins, Ingredient . . . . .	233	Basting . . . . .	200-202	Chili & Soup Servers . . . . .	177
Booster Seats . . . . .	67	Bottle & Jar . . . . .	261	Cocktail Shakers . . . . .	146
Bottle, Oil and Sprayer . . . . .	213	Butcher Block . . . . .	266	Coffee Mugs . . . . .	48
Bottle Brushes . . . . .	261	Coffee Service . . . . .	263	Coffee Service	
Bottle Holders . . . . .	140	Counter Top . . . . .	273	Cheese Shaker/Sugar Pourer . . . . .	60
Bottle Pourers . . . . .	144	Croissant . . . . .	200	Creamer/Pitchers . . . . .	60
Bowls		Cutting Board . . . . .	260	Drip Trays, NeWave . . . . .	104
Balsam Display . . . . .	80	Dish . . . . .	267	Sugar Caddies . . . . .	60
Bell . . . . .	96	Dishwasher Machine . . . . .	264	Colanders & Strainers . . . . .	209
Clam Shells . . . . .	96	Dusters . . . . .	274	Coldmaster Products	
Designer Displayware . . . . .	89	Equipment . . . . .	264, 266	CaterCooler . . . . .	176
Double Wall Stainless Steel . . . . .	98	Ergonomic Hand Scrubs . . . . .	265	Coldmaster Chillers . . . . .	110
Epicure Acacia Wood Grain . . . . .	88	Food Preparation . . . . .	203	Coldmaster Coldcrock & Accessories . . . . .	116
Epicure Displayware . . . . .	86	General Clean Up . . . . .	72	Coldmaster Coldpans . . . . .	113
Flared Square . . . . .	81	Glass Washing . . . . .	261	Coldmaster Condiment Bar	
Gathering . . . . .	13	Grill Bricks . . . . .	269	Organizers . . . . .	117

<b>PRODUCT</b>	<b>PAGE</b>	<b>PRODUCT</b>	<b>PAGE</b>	<b>PRODUCT</b>	<b>PAGE</b>
Coldmaster CoolCheck . . . . .	108	Dinnerware		Octagonal Crocks . . . . .	92
Coldmaster Dispenser . . . . .	117	Dallas Ware . . . . .	18-19	Orchid Deli Bowls . . . . .	91
Coldmaster EZ Access Lids . . . . .	112	Dayton . . . . .	22-23	Palette Designer Displayware . . . . .	84-85
Coldmaster Ice Cream Server, Shroud & Lid. . . . .	28, 115	Durus . . . . .	14-15	Pebbled Bowls . . . . .	97
Coldmaster Standard Food Pans & Lids . . . . .	111	Epicure . . . . .	27	Petal Mist . . . . .	29, 95
Designer Coldmaster . . . . .	114	Gathering . . . . .	13	Rave Displayware . . . . .	82
Condiment Bars & Accessories . . . . .	117	Grove . . . . .	12	Rectangular Crocks & Platter . . . . .	94
Condiment Caddies . . . . .	131, 141	Halcyon . . . . .	10	Risers . . . . .	99
Condiment Organizers . . . . .	128	Kingline . . . . .	20-21	Salad Bowl . . . . .	87
Condiment Pumps . . . . .	128-129	Mingle . . . . .	11	Scalloped Platters . . . . .	83
Containers		Polycarbonate, Commercial . . . . .	24	Scalloped DeliWare & Inset . . . . .	87
Bains Maries . . . . .	232	Ridge . . . . .	9	Scoop Bowl . . . . .	90
Crocks . . . . .	118-119	Sierrus . . . . .	16-17	Stack Bowls . . . . .	96
Economical Space Savers . . . . .	230	Square . . . . .	26	Stands . . . . .	82
Food Boxes . . . . .	226-227	Stadia . . . . .	8	Terra Displayware . . . . .	83
Food Pans . . . . .	218-225	Terra . . . . .	25	Tulip Deli Crocks . . . . .	90
Rounds . . . . .	231	Dish Dollies, Optimizer . . . . .	319-320	Disposable Lids . . . . .	52-53
Squares . . . . .	228-229	Dish Racks		Double Boiler . . . . .	185
Cookware		All-Purpose Plate & Tray Rack . . . . .	247	Drain Grates . . . . .	224
Braziers . . . . .	184	Combination/Flatware Rack . . . . .	246	Dredges/Powder Cans . . . . .	208
Covers . . . . .	186-187	Cup Racks . . . . .	247	Drinkware . . . . .	36-46, 48
Double Boiler . . . . .	185	Dollies . . . . .	249	Drip Trays . . . . .	104
Fry Pans . . . . .	182-183	Dust Cover . . . . .	249	Dust Pans & Lobby Brushes . . . . .	285-286
Mesh Baskets . . . . .	187	Food Pan Rack . . . . .	247	Dusters . . . . .	274
Sauce Pans . . . . .	185	Open/Bowl Racks . . . . .	246	End Loaders	
Sectional . . . . .	185	Peg Racks . . . . .	246	Cateraide IT . . . . .	171
Stock Pots . . . . .	184	Plaque-A-Rack System . . . . .	250-251	Cateraide Slide 'N Seal . . . . .	173
Covers		Rack Cover . . . . .	249	CaterCooler . . . . .	176
Burger . . . . .	187	Dishers . . . . .	205	Dollies . . . . .	178
Cake . . . . .	99	Dishes, Roll-Top . . . . .	66	Insulated . . . . .	176
Compartment Tray . . . . .	160	Dispensers		Floor Brushes	
Cookware . . . . .	186-187	Counter Top Lid & Straw Dispenser . . . . .	131	Dual Surface Brushes . . . . .	287
Custom, Plate . . . . .	33	Cup Dispensers . . . . .	130	Handle Guide . . . . .	310-311
Display . . . . .	99	Straw Dispenser . . . . .	131	Handles . . . . .	293-295
Palette Displayware . . . . .	85	Toothpick Dispenser . . . . .	131	Racks . . . . .	296
Pastry Tray . . . . .	160	Display Cases, Pastry . . . . .	127	Scrubs . . . . .	287-288
Plate . . . . .	32	Display Cubes . . . . .	105	Swivel Floor Brushes . . . . .	288
Creamer . . . . .	60	Displayware		Tile & Grout Brushes . . . . .	289
Crocks		Balsam . . . . .	80	Floor Maintenance	
Classic Crocks . . . . .	118	Bell Bowls . . . . .	96	Boot 'N Shoe Brush . . . . .	309
Gourmet . . . . .	119	Clam Shells . . . . .	96	Caution Cones . . . . .	307
Octagonal . . . . .	92	Designer Displayware . . . . .	89	Floor Drain Brush . . . . .	308
Poly-Tuf . . . . .	118	Double-Wall Stainless Steel Displayware . . . . .	98	Floor Drain Opener . . . . .	308
Rectangular . . . . .	94	Epicure Acacia Wood Grain . . . . .	88	Floor Sweepers . . . . .	286
Supreme . . . . .	119	Epicure Displayware . . . . .	86	Wet Floor Signs . . . . .	307
Tulip Deli . . . . .	90	Flared Square Bowls . . . . .	81	Floor Rack System . . . . .	233
Cup Dispensers . . . . .	130	Leaf Bowls . . . . .	96	Floor Squeegees	
Dessert Dishes . . . . .	28	MirAcryl Cubes . . . . .	105	Double Foam Squeegees . . . . .	289-290
		Mirrored Trays . . . . .	104	Handle Guide . . . . .	275, 310-311
		Modular Displayware . . . . .	93	Handles . . . . .	293-295
		Narrow Rimmed . . . . .	86	Racks . . . . .	296
		Octagon Bowls . . . . .	92	Rubber Squeegees . . . . .	291-292
				VersaClean Brush & Squeegees . . . . .	292

continued on next page »

<b>PRODUCT</b>	<b>PAGE</b>	<b>PRODUCT</b>	<b>PAGE</b>	<b>PRODUCT</b>	<b>PAGE</b>
Floor Sweeps		Ice Caddies, Cateraide . . . . .	179	Pans, Baking	
Omni Sweep . . . . .	282	Ice Cream Server, Shroud		Bake Pans . . . . .	188-189
Fine Floor Sweeps . . . . .	283	& Lid, Coldmaster . . . . .	28, 115	Cupcake Pans . . . . .	190
Handle Guide . . . . .	275, 310-311	Ice Only Container . . . . .	199	Icing Grates . . . . .	191
Handles . . . . .	293-295	Ice Scoops . . . . .	145, 199	Muffin Pans . . . . .	190
Heavy Floor Sweeps . . . . .	284	Ice Sculptures . . . . .	103	Pullman Pans . . . . .	190
Medium Floor Sweeps . . . . .	283	Ice Totes, Containers . . . . .	199	Loaf Pans . . . . .	190
Multi-Surface Floor Sweeper . . . . .	286	Icing Grates . . . . .	191	Roast Pans . . . . .	188-189
Racks . . . . .	296	Ingredient Bins . . . . .	233	Sheet Pans . . . . .	191
Sweep Complete . . . . .	282	Insulated Food		Pasta Cookers, Sectional . . . . .	185
Food Bars		Pan Carriers . . . . .	171, 173, 176-177	Pasta Forks . . . . .	121
Adapter Bars . . . . .	225	J-Jars . . . . .	61	Pastry Brushes . . . . .	200-202
Buffet Bars . . . . .	126	Janitorial Carts & Accessories . . . . .	321	Pastry Display Cases . . . . .	127
Five-Star . . . . .	126	Ladles . . . . .	100-101, 121	Pastry Tray Covers . . . . .	160
Maximizer . . . . .	122-123	Lid & Condiment Organizer . . . . .	131	Pitchers . . . . .	49-51, 60
Six-Star . . . . .	124-125	Liquor Pourers . . . . .	144-145	Plate Covers	
Sneeze Guards . . . . .	127	Lobby Pans . . . . .	285-286	Custom Plate Covers . . . . .	33
Tabletop . . . . .	124-125	Measurers		Polycarbonate Plate Covers . . . . .	32
Youth . . . . .	124-125	Commercial . . . . .	204	Polyglass Plate Covers . . . . .	32
Food Boxes & Containers		Dishers . . . . .	205	Plate Stands . . . . .	82
Bains Marie . . . . .	232	Measure Misers . . . . .	205-207	Plates	
Color-Coded . . . . .	226-227	Measuring Cups . . . . .	204	Charger . . . . .	30
Economical Space Saver . . . . .	230	One Gallon Containers . . . . .	203	Epicure Acacia Wood Grain . . . . .	88
Food Storage Boxes & Lids . . . . .	226-227	Portioning Cups . . . . .	203	Leaf . . . . .	29
Round Containers & Lids . . . . .	231	Microfiber Cloths . . . . .	274	Petal Mist . . . . .	29, 95
Square Containers & Lids . . . . .	228-229	Microwave-Ware . . . . .	31	Portable Bar & Accessories . . . . .	136-137
Food Pans		Mixing Bowls . . . . .	209	Powder Cans & Dredges . . . . .	208
Coldmaster Food Pans . . . . .	113	Money Maid Combo Packs . . . . .	161	Pump Kit . . . . .	128
Drain Grates . . . . .	224	Mop Buckets . . . . .	307	Punch Bowls . . . . .	104
Drain Shelves . . . . .	220, 222-223	Mops & Accessories		Ramekins	
DuraPan Food Pans		Cut-End Mops . . . . .	303-304	Butter Dish . . . . .	57
& Accessories . . . . .	224-225	Dust Mops . . . . .	298	Japanese Style . . . . .	57
EZ Access Lids . . . . .	218, 220-222	Looped-End Mops . . . . .	301-302	Melamine . . . . .	58
High Heat Pans . . . . .	218, 222-223	Microfiber Mops . . . . .	297	Molcajete . . . . .	58
Palette Designer Displayware Pans . . . . .	84-85	Microfiber Bucket . . . . .	298	Oval . . . . .	56
Polycarbonate Pans . . . . .	218, 220	Mop Bucket & Wringer Combos . . . . .	307	Salsa Dishes . . . . .	58
Smart Lids . . . . .	219	Mop Guide . . . . .	299-300	SAN . . . . .	59
Specialty Food Pans . . . . .	223	Mop Handles . . . . .	297, 304-306	Sauce Cups . . . . .	59
Universal Food Pan Lids . . . . .	218	Screw Top Mops . . . . .	304	Scalloped . . . . .	57
Food Preparation Brushes . . . . .	203	Sponge Mops . . . . .	305	Square . . . . .	56
Food Stations . . . . .	128	Muffin Pans . . . . .	190	Stainless Steel . . . . .	59
French Whips . . . . .	212	Mugs		Straight Sided . . . . .	56
Fry Pans . . . . .	182-183	Coffee . . . . .	48	Rectangular Microfiber Bucket . . . . .	298
Fryer Baskets . . . . .	187	Lexington . . . . .	48	Recycle Containers & Lids . . . . .	330-331
Glass Rimmers . . . . .	144	Order Racks . . . . .	198	Recycle Lable Kit . . . . .	331
Grill Bricks, Screens . . . . .	269	Order Wheels . . . . .	198	Restroom Maintenance	
Hand & Nail Brushes . . . . .	270	Oven/Broiler Brushes, Scrapers . . . . .	268-269	Bowl Brushes . . . . .	309
Handles &		Packet Racks . . . . .	128	Force Cup . . . . .	309
Accessories . . . . .	293-297, 304-306, 310-311	Paddle Scrapers . . . . .	210-211	Risers . . . . .	99
Handle Guide . . . . .	275, 310-311	Pan Carriers . . . . .	171, 173, 176-177	Salad Bars . . . . .	122-126
Heat Lamps . . . . .	196-197			Salsa Dishes & Bowls . . . . .	56-59
Ice Buckets . . . . .	147			Sauce Cups . . . . .	59

<b>PRODUCT</b>	<b>PAGE</b>	<b>PRODUCT</b>	<b>PAGE</b>	<b>PRODUCT</b>	<b>PAGE</b>
Scoops . . . . .	199, 145	Tortilla Servers . . . . .	64-65	Turners . . . . .	216
Scrapers . . . . .	210-211	Tote Boxes & Lids . . . . .	252-253	Vases, Bud . . . . .	61
Scrubs, Sponges . . . . .	267	Trays		Warewashing Racks & Accessories	
Service Mat & Bar Mat . . . . .	143	Bakery . . . . .	151	Color-Coded . . . . .	240-245
Serving Spoons, Buffet Spoons & Pasta Forks . . . . .	100-102, 120-121	Bar . . . . .	162-163	Customized . . . . .	238-239
Servingware . . . . .	100-102, 120-121	Bistro . . . . .	157	Dish . . . . .	246-247
Shaker/Dredge . . . . .	208	Café . . . . .	157	Dollies . . . . .	249
Shakers, Cocktail . . . . .	146	Cake . . . . .	99	Dust Cover . . . . .	249
Sheet Pan Carriers . . . . .	177	Carrier, Insulated . . . . .	177	Flatware . . . . .	248
Shelf Liner & Bar Mat . . . . .	143	Celebration, Chrome Plated . . . . .	164	Glass . . . . .	240-245
Shovels . . . . .	213	Compartment . . . . .	158-160	Hold Down Grid . . . . .	248
Skimmers, Wire Mesh . . . . .	209	Cork . . . . .	163	NeWave . . . . .	241
Sneeze Guards . . . . .	126-127	Covers . . . . .	160	OptiClean Rack System . . . . .	236-237
Soup & Chili Servers . . . . .	177	Display . . . . .	151	Placque-A-Rack System . . . . .	250-251
Soup Service . . . . .	31	Drip . . . . .	104	Rack Cover . . . . .	249
Spatulas . . . . .	210-211	Festival . . . . .	165	Specialty . . . . .	246-248
Specialty Racks . . . . .	246-248	Fiberglass . . . . .	150-156	Waste Containers	
Speed-Rak Bottle Holders . . . . .	140	Glasteel . . . . .	150-155	50-Gallon Roll Away . . . . .	325
Sponges, Scour Pads . . . . .	267	GripLite . . . . .	163	Bronco & Lids . . . . .	324-325
Spoons . . . . .	100-102, 120-121	Griptite 2 . . . . .	162	Centurian . . . . .	328
Spouts . . . . .	144, 263	Handled . . . . .	161	Compost . . . . .	330-331
Spouts, Pumps & Valves . . . . .	263	Illuminated . . . . .	103	Dollies . . . . .	326-327
Squeegees		Low Edge . . . . .	151	Fire Resistant . . . . .	329
Floor . . . . .	289-292	Market . . . . .	156	Hot Stamped . . . . .	325
Window . . . . .	275	Metric . . . . .	151	Office Wastebaskets . . . . .	329
Step Risers . . . . .	99	MirAcryl Mirrored Display . . . . .	104	Recycle Containers & Accessories . . . . .	330-331
Store 'N Pour		Octagonal . . . . .	164	Roll-Away, 50 Gallon . . . . .	326
PourPlus . . . . .	138	Oval . . . . .	162-164	Tool Caddy Bag . . . . .	325
Complete Units & Backups . . . . .	139	Petal Mist . . . . .	95	TrimLine . . . . .	327
Condiment System . . . . .	142	Racks . . . . .	247	Wet Floor Signs . . . . .	307
Speed Spout . . . . .	138-139	Rectangular . . . . .	151, 157, 162-165	Whips, French . . . . .	212
Bar Service Pack . . . . .	139	Room Service . . . . .	161	Window Maintenance	
Strainers & Colanders . . . . .	209	Round . . . . .	66, 162-165	Squeegees . . . . .	275
Straw Dispenser . . . . .	131	Stands . . . . .	165	Scrapers . . . . .	275
Sugar Caddies . . . . .	60	Tip . . . . .	161	Wine Buckets & Stands . . . . .	146
Sugar Pourer/Cheese Shaker . . . . .	60	Trapezoid . . . . .	151, 157	Wine Holder . . . . .	147
Syrup Pitchers . . . . .	60	Wrap Trays . . . . .	150	Wine Servers & Coolers . . . . .	146-147
Ticket Wheels . . . . .	198	Tulip Dishes . . . . .	28	Wire Mesh Baskets . . . . .	187
Tilt Trucks . . . . .	332-333	Tumblers		Wire Mesh Skimmers . . . . .	209
Tip Trays . . . . .	161	Bistro . . . . .	42	Woven Baskets . . . . .	62
Tongs . . . . .	102, 120-121, 212	Coca-Cola, Genuine Tumbler . . . . .	43		
Tool Caddy Bag . . . . .	325	Coca-Cola, Stackable . . . . .	40		
Toothpick Dispenser . . . . .	131	Crystalon RimGlow . . . . .	45		
Top Loaders		Crystalon Stack-All . . . . .	42		
Cateraide IT . . . . .	171	Lafayette . . . . .	46		
Cateraide Slide 'N Seal . . . . .	173	Lorraine . . . . .	41		
CaterCooler . . . . .	176	Mingle . . . . .	38		
Dollies . . . . .	178	Louis . . . . .	41		
Insulated . . . . .	177	Pebble Optic . . . . .	43		
Topping Rails . . . . .	129	Pepsi . . . . .	40		
		Stackable . . . . .	39, 45		
		Swirl . . . . .	46		



**CARLISLE**  
FOODSERVICE PRODUCTS





# ELEGANT VERSATILE DURABLE BEAUTIFUL **DINNERWARE**

---

*Carlisle offers a wide array of guest pleasing dinnerware choices that can coordinate with every type of venue and cuisine. Set your table with Carlisle and watch the savings stack up vs. traditional dinnerware. Our durable collections are designed to be beautiful and long-lasting.*



# MELAMINE DINNERWARE

Inspired by **classical design and nature**, Stadia blends clean lines with **subtle organic shapes** to delight the eye and add contemporary style to any tabletop. Incorporating **stadium-shaped bowls and coupe plates**, Stadia offers a **refreshing take on traditional design fused with a modern twist** on conventional white dinnerware.



## Stadia

- Stadium-shaped bowls and coupe plates with organic shapes offer plating options for any table setting
- Made from heavy-weight melamine resistant to breaking, staining, chipping and cracking
- Look and feel of china without the replacement cost making Stadia a smart investment
- Refreshing neutrals of luminous white and warm grey-beige emphasize food presentation and coordinates with any tabletop décor
- Safe for temperatures up to 212°F
- Dishwasher safe; NSF Listed
- One-year limited warranty



**NEW  
PRODUCT**



Prod No	Description	Color	Pack
<b>Stadia Dinnerware</b>			
53000 Δ	10.5" Dinner Plate	02, 80	12 ea
53001 Δ	9" Salad Plate	02, 80	12 ea
53002 Δ	7.25" Bread and Butter Plate	02, 80	12 ea
53003 Δ	8.5" Pasta Plate	02, 80	12 ea
53004 Δ	9.5" Pasta Plate	02, 80	12 ea
53005 Δ	11.5" Pasta Plate	02, 80	12 ea
53006 Δ	12 oz Bowl	02, 80	12 ea
53007 Δ	32 oz Bowl	02, 80	12 ea
53008 Δ	52 oz Bowl	02, 80	12 ea
53009 Δ	13" x 17" Platter	02, 80	12 ea
53010 Δ	4 oz Sauce Cup	02, 80	24 ea
53011 Δ	2 oz Sauce Cup	02, 80	24 ea

NSF Listed products are designated with a Δ and may be prefixed with an N  
 Note: Melamine Dinnerware is not recommended for microwave

Inspired by **Earth's natural elements**, our new Ridge collection suggests the **look and texture of stone** with the benefits and **durability of melamine**. Modern, minimalist shapes from bouillon bowls to platters offer a **variety of plating options**.

### Ridge

- Neutral & natural colors compliment any plate from ethnic-inspired dishes to farm-to-table culinary creations
- Featuring modern, minimalist organic shapes, premium texture and matte finish
- Ideal where breakage is a concern, such as the poolside
- Durable melamine resists staining, chipping and cracking
- Safe for temperatures up to 212°F
- Dishwasher safe
- One-year limited warranty



Prod No	Description	Color	Pack
<b>Ridge Dinnerware</b>			
53107	10.5" Dinner Plate	23, 37, 38, 72	12 ea
53101	10" Coupe Plate	23, 37, 38, 72	12 ea
53106	9" Salad Plate	23, 37, 38, 72	12 ea
53105	11" Rimless Plate	23, 37, 38, 72	12 ea
53104	9" Rimless Plate	23, 37, 38, 72	12 ea
53103	18" Oblong Platter	23, 37, 38, 72	6 ea
53102	13" Oblong Platter	23, 37, 38, 72	6 ea
53109	52 oz Bowl	23, 37, 38, 72	12 ea
53108	22 oz Bowl	23, 37, 38, 72	12 ea
53110	8 oz Bouillon Bowl	23, 37, 38, 72	24 ea

Note: Melamine Dinnerware is not recommended for microwave

# MELAMINE DINNERWARE

The Halcyon serving ware collection offers perfect plating for a variety of cuisines and food styles. Featuring durable bone-white melamine, Halcyon provides artful plating choices for sushi, salads, pasta, appetizers and more. The collection also includes an assortment of dip bowls, flight trays and spoons. Take your dining and presentation to a new level.

## Halcyon

- Unique design enhances the appearance of plated foods
- Made of sturdy, durable, heavy-weight melamine
- Resists oils and staining
- Wide variety including 26 shapes and sizes of plates, platters, serving cups and bowls
- Bone-white is a perfect neutral backdrop for your meal presentation
- Safe for temperatures up to 212°F
- NSF Listed; dishwasher safe
- One-year limited warranty



White(02)

Prod No	Description	Color	Pack
<b>Halcyon Dinnerware</b>			
HAL01 $\Delta$	5", 12 oz Flared Rim Appetizer Cup	02	12 ea
HAL02 $\Delta$	5.5", 18 oz Flared Rim Appetizer Cup	02	12 ea
HAL03 $\Delta$	10", 16 oz Oval Pasta Bowl	02	12 ea
HAL04 $\Delta$	12", 6 oz Round Pasta Bowl	02	12 ea
HAL05 $\Delta$	5", 11 oz Angled Appetizer Cup	02	12 ea
HAL06 $\Delta$	6", 16 oz Angled Appetizer Cup	02	12 ea
HAL09 $\Delta$	9" Square Rim Plate	02	12 ea
HAL10 $\Delta$	10-1/2" Square Rim Plate	02	12 ea
HAL11 $\Delta$	12" Square Rim Plate	02	12 ea
HAL12 $\Delta$	3 Compartment Tray	02	6 ea
HAL13 $\Delta$	7.62 x 7" x 3", 3 oz Small Lily Bowl	02	12 ea
HAL14 $\Delta$	10.5" x 9" x 4.25", 8 oz Medium Lily Bowl	02	12 ea
HAL15 $\Delta$	11.5" x 9.5" x 4.5", 10 oz Large Lily Bowl	02	12 ea

Prod No	Description	Color	Pack
<b>Halcyon Dinnerware</b>			
HAL16 $\Delta$	10" Serving Platter	02	12 ea
HAL17 $\Delta$	11.5" Serving Platter	02	12 ea
HAL18 $\Delta$	13" Serving Platter	02	6 ea
HAL20 $\Delta$	4", 20 oz Petite Sauce Bowl	02	24 ea
HAL21 $\Delta$	4.5", 2 oz Handled Sauce Bowl	02	24 ea
HAL22 $\Delta$	11", 8 oz Top Hat Pasta Bowl	02	12 ea
HAL23 $\Delta$	12", 5 oz Oval Low Bowl	02	12 ea
HAL24 $\Delta$	10.5" x 6.5" Small Serving Plate	02	12 ea
HAL26 $\Delta$	13" x 6.5" Sleigh Tray	02	12 ea
HAL27 $\Delta$	.25 oz Pho Spoon	02	48 ea
HAL28 $\Delta$	.25 oz Broth Spoon	02	48 ea
HAL31 $\Delta$	2.5", 1 oz Spoon Bowl	02	48 ea
HAL32 $\Delta$	3.5", 2 oz Handled Bowl	02	48 ea

NSF Listed products are designated with a  $\Delta$  and may be prefixed with an N  
 Note: Melamine Dinnerware is not recommended for microwave

Mingle's swirl design draws attention to the center of the plate – **putting the focus on your culinary creations.**

### Mingle

- Perfect for employee dining, pool & resort dining or any casual venue where durability is ideal
- Textured body and swirl design puts the focus on your culinary creations
- Base color mimics ceramics
- Safe for temperatures up to 212°F
- NSF Listed; dishwasher safe
- One-year limited warranty



Prod No	Description	Color	Pack
<b>Mingle Dinnerware</b>			
54001 $\Delta$	11" Dinner Plate	13, 15, 17, 18, 46, 52	12 ea
54002 $\Delta$	9" Salad Plate	13, 15, 17, 18, 46, 52	12 ea
54003 $\Delta$	9", 28.5 oz Rimmed Soup	13, 15, 17, 18, 46, 52	6 ea
54004 $\Delta$	7", 27 oz Ice Cream Bowl	13, 15, 17, 18, 46, 52	12 ea
54005 $\Delta$	6", 17 oz Bowl	13, 15, 17, 18, 46, 52	12 ea
54007 $\Delta$	7" Bread & Butter Plate	13, 15, 17, 18, 46, 52	12 ea
54018 $\Delta$	5", 4.5 oz Fruit Bowl	13, 15, 17, 18, 46, 52	48 ea
54019 $\Delta$	8", 35.5 oz Cereal Bowl	13, 15, 17, 18, 46, 52	12 ea

NSF Listed products are designated with a  $\Delta$  and may be prefixed with an N  
 Note: Melamine Dinnerware is not recommended for microwave

# MELAMINE DINNERWARE

Grove features **classic shapes with unique features and patterns.**

For **use inside and out**; dress up a table for everyday entertaining or use worry-free **for school, church, parties, poolside or barbecues.**

## Grove

- Temperature insulated; resists drawing heat or cold away from food
- Durable, heavy-weight melamine with the look of stoneware resists chipping and breakage
- Mix and match Grove's complimentary neutral colors or pair with traditional solid pieces from other collections
- Gently stroped design imitates the look of weathered wood and lends itself to standardized plating
- One-year limited warranty against breakage
- Safe for temperatures up to 212°F
- Dishwasher safe; NSF listed



Prod No	Description	Color	Pack
<b>Grove Dinnerware</b>			
64001 $\Delta$	11" Dinner Plate	06, 15*, 18, 46, 70	12 ea
64002 $\Delta$	9" Salad Plate	06, 15, 18, 46, 70	12 ea
64007 $\Delta$	7" Bread & Butter Plate	06, 15, 18, 46, 70	12 ea
64020 $\Delta$	12" x 8" Oval Plate	06*, 15, 18, 46, 70	12 ea
64022 $\Delta$	10.5" x 10.5" Square Dinner Plate	06, 15, 18, 46, 70	12 ea
64023 $\Delta$	8.5" x 8.5" Square Salad Plate	06, 15, 18, 46*, 70*	12 ea
64003 $\Delta$	9", 28.5 oz Soup Bowl	06, 15, 18, 46, 70	6 ea
64005 $\Delta$	6", 17 oz Small Bowl	06, 15, 18, 46*, 70	12 ea
64013 $\Delta$	7", 27 oz Ice Cream Bowl	06*, 15, 18, 46, 70	12 ea
64018 $\Delta$	5", 4.5 oz Fruit Bowl	06, 15, 18, 46, 70	48 ea

NSF Listed products are designated with a  $\Delta$  and may be prefixed with an N

Note: Melamine Dinnerware is not recommended for microwave

\* Color available by special order only

Gathering has an organic **look of beautiful hand-thrown pottery** with the lasting time-tested **durability and weight of melamine**. Gathering designs feature **larger plating surfaces**. **Texture and color complete the mood** in a variety of dining settings.

## Gathering

- The modern European coupe design is on-trend and offers larger plating surfaces
- The unique look fits perfectly within the farm-to-table setting
- Heavy-weight melamine is dishwasher safe and stain resistant making Gathering a great investment
- Safe for temperatures up to 212°F
- One-year limited warranty against breakage
- NSF Listed



Adobe(70)

Prod No	Description	Color	Pack
<b>Gathering Dinnerware</b>			
GA55001 $\Delta$	11" Dinner Plate	70	12 ea
GA55002 $\Delta$	9" Salad Plate	70	12 ea
GA55008 $\Delta$	7" Bread & Butter Plate	70	12 ea
GA55003 $\Delta$	8", 35.5 oz Small Bowl	70	12 ea
GA55011 $\Delta$	6", 20 oz Small Bowl	70	12 ea
GA55012 $\Delta$	4.62", 9 oz Dip Bowl	70	12 ea
GA55013 $\Delta$	12.5" Charger Plate	70	12 ea
GA55014 $\Delta$	12" x 8" Oval Platter	70	12 ea

NSF Listed products are designated with a  $\Delta$  and may be prefixed with an N

Note: Melamine Dinnerware is not recommended for microwave

# MELAMINE DINNERWARE

Durus looks and feels like porcelain dinnerware without the replacement costs due to chipping or breaking. **Switch to Durus and watch the savings pile up!**

## Durus®

- High quality, heavy-weight melamine dinnerware has the look and feel of china without the replacement cost
- Available in 9 solid colors
- Minimize your scratch and stain problems with our exclusive mirror-like glaze
- See a return on investment in less than 18 months in most operations after switching to Durus from china
- Reduce dinnerware drying time with the advanced Durus foot design and slick water-sheeting glazed surface
- Save money with our Durus four-year warranty\* against breakage, the best guarantee in the industry
- Mix and match Durus side dishes with china plates for a beautiful tabletop that costs less to maintain
- Custom decorating available; see page 334
- Safe for temperatures up to 212°F
- Four-year limited warranty
- NSF Listed; dishwasher safe

Coordinating Ramekins & Soup Bowls are also shown below. Additional information on coordinating pieces can be found in the Drinkware & Tabletop Accessories catalog sections.





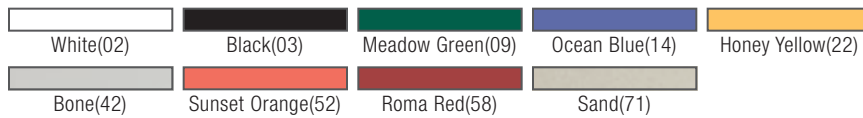

Prod No	Description	Color	Pack
<b>Durus Narrow Rim Plates</b>			
43000 Δ	10.5" 3-Compartment Plate	42	12 ea
43002 Δ	10.5" Dinner Plate	02, 09, 14, 22, 42, 52	12 ea
43004 Δ	9" Dinner Plate	02, 09, 14, 22, 42, 52, 58, 71	24 ea
43006 Δ	7.25" Salad Plate	02, 09, 14, 22, 42, 52	48 ea
43008 Δ	6.5" Pie Plate	02, 03, 09, 14, 22, 42, 52, 71	48 ea
<b>Durus Wide Rim Plates</b>			
43024 Δ	12" Dinner Plate	02	12 ea
43010 Δ	10.5" Dinner Plate	02, 14, 22, 42, 52*	12 ea
43012 Δ	9" Dinner Plate	02, 09, 14, 22, 42, 52	24 ea
43016 Δ	7.5" Salad Plate	02	48 ea
43018 Δ	6.5" Pie Plate	02, 14, 42	48 ea
<b>Durus Oval Platters</b>			
43080 Δ	13.5" x 10.5" Oval Platter	02, 09, 14, 22*, 42, 52, 71	12 ea
43082 Δ	12" x 9.25" Oval Platter	02, 03, 09, 14, 22, 42, 52, 58, 71	12 ea
43086 Δ	9.5" x 7.25" Oval Platter	02, 03, 22*, 42, 52*	24 ea
<b>Durus Bowls &amp; Cup</b>			
43030 Δ	20 oz, 12" Chef Salad/Pasta Bowl	02, 03, 09, 14, 22, 42, 52, 58	12 ea
43032 Δ	16 oz, 7.5" Rimmed Bowl	02, 03, 14, 22, 52	24 ea
43034 Δ	13 oz, 9.25" Pasta/Soup/Salad Bowl	02, 09*, 14, 22, 42, 52*, 58	24 ea
43036 Δ	12 oz, 7.25" Rimmed Bowl	02, 09, 14, 22, 42, 52, 71	24 ea
43038 Δ	10 oz, 5.38" Rimmed Nappie Bowl	02, 09, 14, 22, 42, 52	24 ea
43040 Δ	6 oz, 6" Rimmed Bowl	02, 09, 14, 22, 42, 52	48 ea
43042 Δ	4.5 oz, 4.75" Rimmed Fruit Bowl	02, 09, 14, 22, 42, 52, 58, 71	48 ea
43050 Δ	7 oz, 4" Bouillon Cup	02, 03, 09, 14, 22, 42, 52, 71	48 ea

NSF Listed products are designated with a Δ and may be prefixed with an N

Note: Melamine Dinnerware is not recommended for microwave

\* Color available by special order only

# MELAMINE DINNERWARE

Dress your dining table with the **beauty and feel of porcelain** at a fraction of the price. Sierrus Dinnerware is a **medium weight** version of our popular Durus design. Mix and match Durus with Sierrus to make your budget go farther.

## Sierrus™

- All purpose, medium-heavy weight dinnerware has the same design as our Durus® line
- Available in eight solid colors
- Made of heavy-duty, break-resistant melamine
- Safe for temperatures up to 212°F
- Two-year limited warranty
- NSF Listed; dishwasher safe

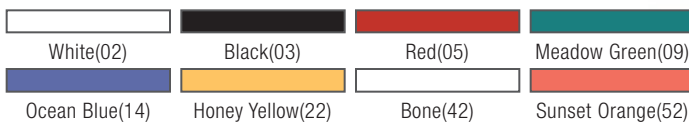

Prod No	Description	Color	Pack
<b>Sierrus Narrow Rim Plates</b>			
33000 $\Delta$	10.5" 3-Compartment Plate	02, 03, 05, 09, 14, 22, 42, 52	12 ea
33002 $\Delta$	10.5" Dinner Plate	02, 03, 05, 09, 22, 42, 52	12 ea
33004 $\Delta$	9" Dinner Plate	02, 03, 05, 09, 14, 22, 42, 52	24 ea
33006 $\Delta$	7.25" Salad Plate	02, 03, 05, 09, 14, 22, 42, 52*	48 ea
33008 $\Delta$	6.5" Pie Plate	02, 03, 05, 09*, 14, 22*, 42, 52	48 ea
<b>Sierrus Wide Rim Plates</b>			
33024 $\Delta$	12" Dinner Plate	02, 03, 05, 09*, 14, 42, 52*	12 ea
33010 $\Delta$	10.5" Dinner Plate	02, 05*, 09*, 14*, 22, 42, 52*	12 ea
33012 $\Delta$	9" Dinner Plate	02, 03, 05, 09, 14, 22, 42, 52	24 ea
33016 $\Delta$	7.5" Salad Plate	02, 05, 09*, 14, 22*, 42, 52	48 ea
33018 $\Delta$	6.5" Pie Plate	02, 03, 05*, 09, 14*, 22, 42, 52*	48 ea
33020 $\Delta$	5.5" Bread & Butter Plate	02, 03*, 05, 09, 14, 42, 52*	48 ea

NSF Listed products are designated with a  $\Delta$  and may be prefixed with an N

Note: Melamine Dinnerware is not recommended for microwave

\* Color available by special order only



### Carlisle Mugs

Carlisle Mugs pair perfectly with the color options of Sierrus Dinnerware.

See page 48 for more information on these great mugs.

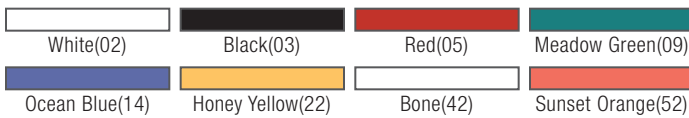

Prod No	Description	Color	Pack
<b>Sierrus Platters</b>			
33080 $\Delta$	13.5" x 10.5" Oval Platter	02, 03, 05, 09, 14, 22, 42, 52*	12 ea
33082 $\Delta$	12" x 9.25" Oval Platter	02, 03, 05, 09, 14, 22, 42, 52	12 ea
33086 $\Delta$	9.5" x 7.25" Oval Platter	02, 03, 05, 09*, 14, 22, 42, 52*	24 ea
<b>Sierrus Bowls &amp; Cup</b>			
33030 $\Delta$	20 oz, 12" Chef Salad/Pasta Bowl	02, 03, 05, 14, 22, 42, 52*	12 ea
33032 $\Delta$	16 oz, 7.5" Rimmed Bowl	02, 03, 05, 09, 14, 22, 42, 52*	24 ea
33034 $\Delta$	13 oz, 9.25" Pasta/Soup/Salad Bowl	02, 03, 05, 09*, 14, 22, 42	24 ea
33036 $\Delta$	12 oz, 7.25" Rimmed Bowl	02, 03, 05, 09, 14, 22, 42, 52	24 ea
33038 $\Delta$	10 oz, 5.38" Rimmed Nappie Bowl	02, 03, 05, 09*, 14, 22, 42, 52	24 ea
33040 $\Delta$	6 oz, 6" Rimmed Bowl	02, 03, 05, 09, 14, 22, 42, 52	48 ea
33042 $\Delta$	4.5 oz, 4.75" Rimmed Fruit Bowl	02, 03, 05, 09, 14, 22, 42, 52	48 ea

NSF Listed products are designated with a  $\Delta$  and may be prefixed with an N

Note: Melamine Dinnerware is not recommended for microwave

\* Color available by special order only

# MELAMINE DINNERWARE

Dallas Ware set the industry standards by which all others are judged. **Quality and durability have been the Dallas Ware trademark for over 50 years.** The NSF listing on all Dallas Ware items ensures the highest sanitary standards.

## Dallas Ware®

- Reinforced rim and foot design stacks with major competitors' products
- Meets PS25-70 specifications
- Safe for temperatures up to 212°F
- One-year limited warranty
- NSF Listed; dishwasher safe

Tabletop Accessories available in coordinating colors.  
See page 58 for more details





White(02)	Black(03)	Red(05)	Meadow Green(09)	Ocean Blue(14)
Honey Yellow(22)	Tan(25)	Café Blue(35)	Bone(42)	Sunset Orange(52)

**Prod No**    **Description**    **Color**    **Pack**

**Dallas Ware Narrow Rim Plates**

43500 Δ	10.25" Dinner Plate	02, 03, 05, 09, 14, 22, 25, 35, 42, 52	48 ea
43501 Δ	9" Dinner Plate	02, 03, 05, 09, 14, 22, 25, 35, 42, 52	48 ea
43503 Δ	7.25" Salad Plate	02, 03, 05, 09, 14, 22, 25, 35, 42, 52	48 ea
43504 Δ	6.5" Pie Plate	02, 25	48 ea
43505 Δ	5.63" Bread & Butter Plate	02, 25, 35	48 ea

**Dallas Ware Compartment Plates**

43512 Δ	11", 1" D, 3-Compartment Plate	35	48 ea
43514 Δ	9.75", 1" D, 3-Compartment Plate	25, 35	36 ea
43516 Δ	9", 1.31" D, 3-Compartment Plate	02, 25	24 ea

**Dallas Ware Oval Platters**

43560 Δ	12" x 8.5" Oval Platter	02, 03, 25, 35	24 ea
43563 Δ	9.25" x 6.25" Oval Platter	02, 03, 25, 35, 42	24 ea

**Dallas Ware Bowls**

43520 Δ	16 oz, 5.75" Nappie Bowl	02, 25	48 ea
43521 Δ	14 oz, 5.5" Nappie Bowl	02, 03, 05, 09, 14, 22, 25, 35, 42, 52	48 ea
43522 Δ	14 oz, 5.5" Rim Nappie Bowl	02, 25, 35	24 ea
43525 Δ	13 oz, 5.25" Nappie Bowl	02, 25, 35	24 ea
43528 Δ	10 oz, 5" Nappie Bowl	02, 25, 35	48 ea
43529 Δ	10 oz, 5.88" Grapefruit Bowl	02, 03, 05, 09, 14, 22, 25, 35, 42*, 52*	48 ea
43531 Δ	4.75 oz, 4.5" Fruit Bowl	02, 25, 35	48 ea
43532 Δ	3.5 oz, 4.13" Fruit Bowl	02, 03, 05, 25, 35	48 ea
43533 Δ	6.5 oz Oval Fruit Dish	02	48 ea
43540 Δ	8 oz, 3.75" Bouillon Cup	02, 03, 05, 09, 14, 22, 25, 35, 42, 52	24 ea

NSF Listed products are designated with a Δ and may be prefixed with an N

Note: Melamine Dinnerware is not recommended for microwave

\* Color available by special order only



# MELAMINE DINNERWARE

Kingline is the top choice for **heavy-duty applications like school cafeterias.** Our medium weight melamine offers **beauty and durability at a great value.**

## Kingline™

- All purpose, medium weight dinnerware meets the tough requirements of heavy-duty foodservice applications
- Durable gloss finish resists chipping, scratching and staining
- Reinforced at vital stress points
- Save even more money with our exclusive Sandshades® variegated dinnerware
- Safe for temperatures up to 212°F
- One-year limited warranty
- NSF Listed; dishwasher safe

# TOP CHOICE FOR SCHOOLS



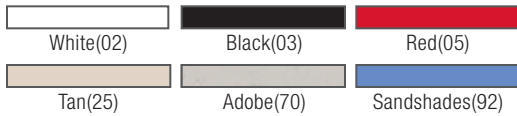

Prod No	Description	Color	Pack
<b>Kingline Plates</b>			
KL116 Δ	10" Dinner Plate	02, 03, 25	48 ea
KL200 Δ	9" Dinner Plate	02, 03, 05, 25, 70	48 ea
KL920 Δ	9" Dinner Plate	92	48 ea
KL201 Δ	7.25" Sandwich Plate	02, 03, 05, 25	48 ea
KL204 Δ	6.5" Pie Plate	02, 03, 05, 25	48 ea
KL205 Δ	5.5" Bread & Butter Plate	02, 25, 70	48 ea
<b>Kingline Compartment Plates</b>			
KL102 Δ	10", .75" D, 3-Compartment Plate	02, 25, 70	48 ea
KL203 Δ	8.75", 1.25" D, 3-Compartment Plate	02, 25	12 ea
<b>Kingline Oval Platters</b>			
KL126 Δ	13.5" x 9.75" Oval Platter	02, 25	12 ea
KL127 Δ	12" x 9" Oval Platter	02, 03, 05, 25, 70**	12 ea
<b>Kingline Bowls &amp; Cup</b>			
KL350 Δ	8 oz Bouillon Cup	02, 03, 05, 25	48 ea
KL115 Δ	16 oz, 6.13" Chowder Bowl	02, 25	48 ea
KL108 Δ	14 oz, 5.5" Nappie Bowl	02, 25	48 ea
KL119 Δ	12.5 oz, 5.5" Rimmed Nappie Bowl	02, 25	48 ea
KL924 Δ	12.5 oz, 5.5" Rimmed Nappie Bowl	92	48 ea
KL121 Δ	10 oz, 5.88" Grapefruit Bowl	02, 25	48 ea
KL118 Δ	10 oz, 5.13" Nappie Bowl	02, 03, 05, 25	48 ea
KL123 Δ	8 oz, 7.75" Wide Rimmed Salad Bowl	02	48 ea
KL800 Δ	5 oz, 5" Rimmed Fruit Bowl	02, 25, 70	48 ea
KL805 Δ	4.75 oz, 4.5" Rimmed Fruit Bowl	02, 03, 05, 25	48 ea
KL928 Δ	4.75 oz, 4.25" Rimmed Fruit Bowl	92	48 ea

NSF Listed products are designated with a Δ and may be prefixed with an N

Note: Melamine Dinnerware is not recommended for microwave

\*Sandshades items vary in color, hue and intensity from piece to piece

\*\* Color available by special order only



# MELAMINE DINNERWARE

With **versatility and strength** on its side, Dayton continues to be a reliable dinnerware choice. **Modern colors** bring life to the table while the **look of ceramic** maintains a classic feel. **Mix and match with Dallas Ware** to acquire a truly customized setting.

## Dayton™

- Withstands the rigors of commercial foodservice dishwasher use
- Maintains its appearance after one year of dishwasher testing
- Dayton melamine is stain-, scratch- and break-resistant, making it ideal for any foodservice operation
- Safe for temperatures up to 212°F
- One-year limited warranty

43866



43864





# 10 GREAT COLORS

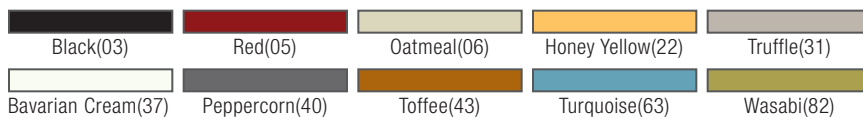

Prod No	Description	Color	Pack
<b>Dayton Dinnerware Plates &amp; Platters</b>			
43850	10.25" Dinner Plate	03, 05, 22, 31*, 37, 40*, 43*, 63, 82	48 ea
43852	9" Dinner Plate	03, 05, 06, 22, 31, 37, 40, 43*, 63, 82	48 ea
43854	7.25" Salad Plate	03*, 05, 06*, 22, 37*, 63	48 ea
43856	5.63" Bread & Butter Plate	03, 05, 06, 22, 37, 63*, 82*	48 ea
43872	9.25" x 6.25" Oval Platter	05, 37	24 ea
<b>Dayton Dinnerware Bowls &amp; Cup</b>			
43858	16 oz, 5.75" Nappie Bowl	03, 05, 06*, 22*, 37, 63*, 82*	48 ea
43860	14 oz, 5.5" Rim Nappie Bowl	03, 05, 06, 22*, 31*, 37, 40, 63, 82	24 ea
43862	10 oz, 5" Nappie Bowl	03, 05, 06*, 22, 37, 43*, 82*	48 ea
43864	10 oz, 5.88" Grapefruit Bowl	03, 05, 06*, 22, 31, 37, 43*, 63*, 82	48 ea
43866	4.75 oz, 4.5" Fruit Bowl	03, 05, 06, 22, 31*, 37*, 40*, 63, 82*	48 ea
43868	8 oz, 3.75" Bouillon Cup	03, 05, 06*, 22*, 31*, 37, 40*, 43*, 63*, 82*	24 ea

Note: Melamine Dinnerware is not recommended for microwave

\* Color available by special order only

# COMMERCIAL DINNERWARE

Polycarbonate material resists stains and chipping

- Designed for corrections, hospitals, schools, long term care facilities, or anywhere long product life and economy are important
- Super-tough polycarbonate dinnerware offers a five-year guarantee against breakage
- Plates have scratch-resistant textured surface
- Stacks with other polycarbonate dinnerware currently on the market
- Temperature use range: -40° to 212°F
- Five-year limited warranty
- NSF Listed; dishwasher safe

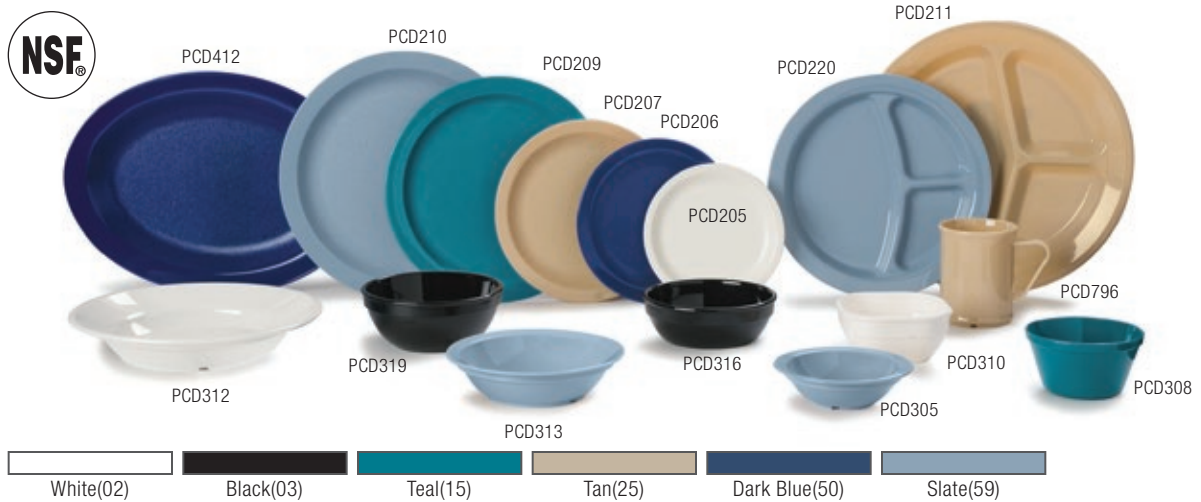

Prod No	Description	Color	Pack
<b>Commercial Dinnerware Plates</b>			
PCD210 ▲	10" Narrow Rim Plate	02, 03, 25, 50, 59	48 ea
PCD209 ▲	9" Narrow Rim Plate	02, 03, 15, 25, 50, 59	48 ea
PCD207 ▲	7.25" Narrow Rim Plate	25	48 ea
PCD206 ▲	6.5" Narrow Rim Plate	02, 03, 50, 59	48 ea
PCD205 ▲	5.5" Narrow Rim Plate	02, 03	48 ea
<b>Commercial Dinnerware Compartment Plates</b>			
PCD211 ▲	11" Narrow Rim 3-Compartment Plate, 1.25" deep	03, 25	48 ea
PCD220 ▲	9" Narrow Rim 3-Compartment Plate, 1" deep	02, 59	48 ea
<b>Commercial Dinnerware Oval Platter</b>			
PCD412 ▲	12" x 9" Oval Platter	02, 03, 50	24 ea
<b>Commercial Dinnerware Bowls &amp; Cup</b>			
PCD319 ▲	15 oz, 5.25" Nappie Bowl	02, 03, 25, 50	48 ea
PCD312 ▲	12 oz, 9" Soup Bowl	02, 03	48 ea
PCD310 ▲	10 oz, 4" Square Bowl	02	48 ea
PCD313 ▲	10 oz, 6" Rimmed Grapefruit Bowl	02, 59, 25	48 ea
PCD316 ▲	10 oz, 5" Nappie Bowl	03	48 ea
PCD308 ▲	8.4 oz, 4" Bouillon Cup	02, 15	48 ea
PCD305 ▲	5 oz, 3.5" Rimmed Fruit Bowl	02, 03, 15, 25, 50, 59	48 ea
<b>Commercial Dinnerware Mug</b>			
PCD796 ▲	9.6 oz Mug	02, 25	48 ea

NSF Listed products are designated with a ▲ and may be prefixed with an N  
 ◆ California Residents: Bisphenol A **WARNING:** See appendix A on page 1

# DINNERWARE ACCENT PIECES

Terra Dinnerware Accents offer the exotic and earthy look of **hand thrown pottery** with the break resistance of heavy duty melamine. The **organic design** blends in with many food presentations and styles.

## Terra™

- The look of heavy-weight, hand thrown pottery blends into a variety of settings and offers an exceptional presentation
- Constructed of a unique, break-resistant material with the look and feel of ceramic
- Safe for temperatures up to 212°F
- One-year limited warranty
- NSF Listed; dishwasher safe



Prod No	Description	Color	Pack
<b>Terra Dinnerware</b>			
43410 $\Delta$	9" Terra Square Plate	02	24 ea
43420 $\Delta$	58 oz, 9.75" Terra Footed Bowl Pack	02, 03	12 ea
43422 $\Delta$	40 oz, 8.5" Terra Footed Bowl	02, 03	12 ea

NSF Listed products are designated with a  $\Delta$  and may be prefixed with an N

# DINNERWARE ACCENT PIECES

## Square

As a tasting plate, an accent dish or the foundation for a grand buffet, square plates are on trend. Our square plates have rounded edges and the fine look of porcelain.

- Squares offer the look of ceramics in long-wearing melamine
- Three sizes hold everything from salads and appetizers to buffet style presentations
- Squared rim design is a sleek take on a classic look
- Made of heavy-duty, break-resistant melamine
- Safe for temperatures up to 212°F
- One-year limited warranty
- NSF Listed; dishwasher safe

## Square Scoops

- Scoop shaped design holds sauces as well as appetizers or side dishes



43304



43306 shown with 7940



7942



7940



7942



Prod No	Description	Color	Pack
<b>Square Dinnerware</b>			
43308 $\Delta$	8" Square Plate	02,03	48 ea
43306 $\Delta$	9.5" Square Plate	02,03	48 ea
43304 $\Delta$	11.5" Square Plate	02,03	48 ea
<b>Square Scoops</b>			
7940 $\Delta$	2 oz, 3.5" Small Square Dish	02	48 ea
7942 $\Delta$	5 oz, 5.25" Small Square Dish	02, 03	48 ea

NSF Listed products are designated with a  $\Delta$  and may be prefixed with an N

## Epicure®

The elegant coupe shape is the perfect frame for larger plating creations. Epicure's coupe shape lends European appeal in durable melamine.

- European coupe design combines strength and beauty with functionality
- Coupe design offers larger serving area
- Safe for temperatures up to 212°F
- One-year limited warranty
- NSF Listed; dishwasher safe

## Epicure® Shapes

### Tasting Plates

- One of a kind shapes add variety when serving appetizers, desserts or specialty foods



Prod No	Description	Color	Pack
<b>Epicure Dinnerware</b>			
43800 $\Delta$	12" Buffet/Pizza Plate	02	12 ea
43801 $\Delta$	10" Dinner Plate	02	48 ea
43803 $\Delta$	8" Dinner Plate	02	48 ea
5933 $\Delta$	32 oz, 8.25" Vegetable Bowl	02	24 ea
43813 $\Delta$	36 oz, 8" Chef Salad/Serving Bowl	02	12 ea
43814 $\Delta$	20 oz, 6.5" Soup/Salad Bowl	02	12 ea
<b>Epicure Shapes</b>			
43806 $\Delta$	11" TriArc Plate	02, 03*	4 ea
43822 $\Delta$	6.25" Square Plate	02	48 ea

NSF Listed products are designated with a  $\Delta$  and may be prefixed with an N

\* Color available by special order only

# DINNERWARE ACCENT PIECES

## Tulip Dishes

- Ideal for serving ice cream, puddings, salads and more
- Stack with similar glass or plastic dessert dishes
- Made of break-resistant SAN
- 4532, 4534 are also available in extra-durable polycarbonate
- Tulip Dishes are the perfect compliment to the Coldmaster® Ice Cream Server shown below
- NSF Listed; dishwasher safe



## Ice Cream Server & Lid

- Coldmaster technology and benefits (see pages 108 – 117)
- Accommodates standard 3-gallon ice cream tubs
- Free, clear polycarbonate lid included with each Coldmaster Ice Cream Server
- Replacement Lids (CM1013) also available

## Ice Cream Shroud

- Attractive stainless steel cover offers an upscale appearance

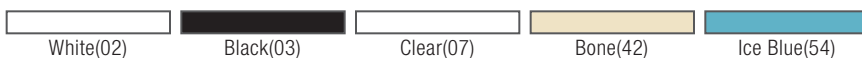
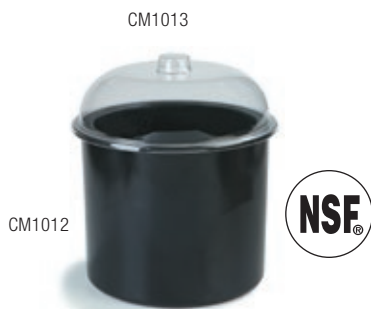

Prod No	Description	Color	Pack
<b>Tulip Dishes</b>			
4530 $\Delta$	5 oz, 3.75" SAN Tulip Dessert Dish	03, 07, 42, 54	24 ea
4532 $\Delta \blacklozenge$	5 oz, 3.75" PC Tulip Dessert Dish	07	24 ea
4531 $\Delta$	5 oz, 4.63" SAN Tulip Berry Dish	03, 07, 42	24 ea
4535 $\Delta$	8 oz, 4.63" SAN Tulip Berry Dish	07	48 ea
4533 $\Delta$	13 oz, 5.5" SAN Tulip Bowl	07	24 ea
4534 $\Delta \blacklozenge$	13 oz, 5.5" PC Tulip Bowl	07	24 ea
<b>Coldmaster Ice Cream Server, Lid &amp; Shroud</b>			
CM1012 $\Delta \blacklozenge$	3 gal Coldmaster Ice Cream Server	02, 03	1 ea
CM1013 $\blacklozenge$	Lid for Coldmaster Ice Cream Server	07	1 ea
38655	Coldmaster Ice Cream Shroud	—	1 ea

NSF Listed products are designated with a  $\Delta$  and may be prefixed with an N

$\blacklozenge$  California Residents: Bisphenol A **WARNING:** See appendix A on page 1

# PLATES & BOWLS

## Tough polycarbonate **Petal Mist**

provides heavy duty serving pieces with a design that looks great longer! Textured exterior hides scratches. Smooth interior makes it easy to clean.

### Petal Mist®

- Perfect for buffets, food bars, delis, poolside and catering
- Made of tough, break-resistant polycarbonate
- Textured exterior hides scratches; smooth interior is easy to clean
- Safe for use in freezers and in temperatures from 40° to 212°F
- See page 95 for additional Petal Mist trays and bowls
- NSF Listed; dishwasher safe



### Leaf Plates

- Intricate leaf pattern enhances food appearance
- Molded of durable SAN for long life
- Dishwasher safe

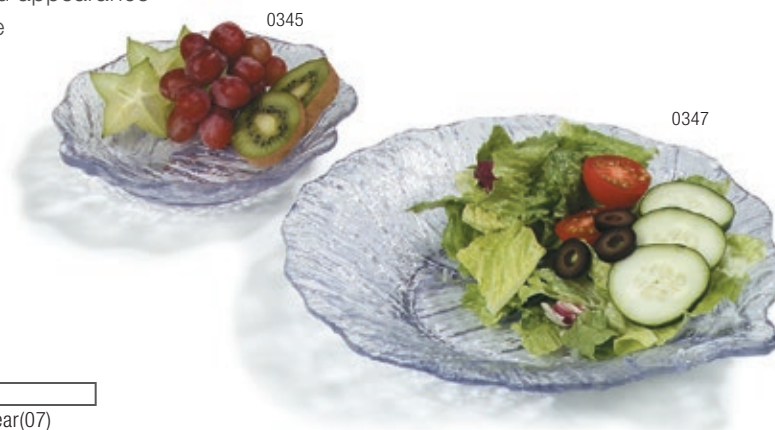

Prod No	Description	Color	Pack
<b>Petal Mist Plates &amp; Bowls</b>			
6904 ▲◆	18 oz, 6" Petal Mist Bowl	03, 07	36 ea
6954 ▲◆	7.5" Petal Mist Plate	07	36 ea
6907 ▲◆	23.9 oz, 8" Petal Mist Soup/Salad Plate	07	36 ea
6956 ▲◆	9" Petal Mist Plate	07	36 ea
<b>Leaf Plates</b>			
0345	6" Leaf Plate	07	36 ea
0347	9" Leaf Plate	07	12 ea

NSF Listed products are designated with a ▲ and may be prefixed with an N  
 ◆ California Residents: Bisphenol A **WARNING:** See appendix A on page 1



# PLATES & BOWLS

## Melamine Salad Bowls

- Made of dependable, impact-resistant melamine
- Safe for temperatures up to 212°F
- NSF Listed; dishwasher safe



## Charger Plates

- Beautiful mirror-finish charger plates are an elegant addition to any place setting
- Easy care tarnish-resistant finish
- Hand wash only



Prod No	Description	Color	Pack
<b>Melamine Salad Bowls</b>			
500B $\Delta$	8 oz, 5.5" Melamine Salad Bowl	03	72 ea
575B $\Delta$	13 oz, 6" Melamine Salad Bowl	03	72 ea
650B $\Delta$	20 oz, 6.5" Melamine Salad Bowl	03	72 ea
800B $\Delta$	24 oz, 7.5" Melamine Salad Bowl	03	48 ea
500M $\Delta$	10 oz, 5.5" Melamine Salad Bowl	20	72 ea
575M $\Delta$	10 oz, 6" Melamine Salad Bowl	20	72 ea
650M $\Delta$	20 oz, 6.5" Melamine Salad Bowl	20	72 ea
800M $\Delta$	27 oz, 7.5" Melamine Salad Bowl	20	48 ea
<b>Charger Plates</b>			
608924	12.25" Charger Plate, Chrome	—	12 ea

NSF Listed products are designated with a  $\Delta$  and may be prefixed with an N



## Microwave-Ware

- Polycarbonate serving accessories designed specifically for microwave cooking
- Stays cool to the touch when coming out of the microwave
- Extremely impact resistant
- Small 8 oz Casserole is perfect for salads and sides—easily doubles as an olive, nut or butter dish on buffets
- Temperature use range: -40° to 212°F
- Dishwasher safe



## Soup Service

- Hefty, thick-walled designs keep food and beverages hot
- Stackable 12 oz Jumbo Soup/Latté Mug (4512) has polycarbonate inner liner and SAN exterior
- 8 and 12 oz handled bowls stack for storage; easy-grab handles are perfect for buffet lines



Our Soup Service Pieces are designed to pair perfectly with our Durus and Sierras Dinnerware.

**See page 14-17 for more information**

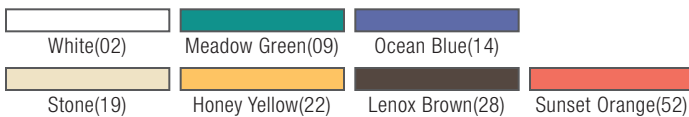

Prod No	Description	Color	Pack
<b>Microwave-Ware</b>			
7400 ▲◆	12 oz, 5.25" x 8.75" Oval Casserole	02	24 ea
7405 ▲◆	8 oz, 4.25" x 7.5" Oval Casserole Dish	02	24 ea
7420 ◆	12 oz, 5.25" Handled Soup Bowl	02	24 ea
<b>Soup Service</b>			
7006	8 oz, 4.63" Handled Soup Bowl	09, 14, 19, 22, 28, 52	24 ea
7008	12 oz, 5.25" Handled Soup Bowl	19, 28	24 ea
4512 ◆	12 oz, 5.5" Jumbo Soup/Latté Mug with White Liner	19, 28	24 ea

NSF Listed products are designated with a ▲ and may be prefixed with an N  
 ◆ California Residents: Bisphenol A **WARNING:** See appendix A on page 1

# PLATE COVERS

## Polyglass Plate Covers

- Available to fit a wide variety of plate sizes and footprints
- Polyglass (PG) plate covers are designed for use in microwaves and heated carts
- Heat resistant to 270°F yet stays cool to the touch; excellent insulation properties
- Impact-resistant material offers a superior alternative to standard fiberglass covers
- NSF Listed; dishwasher safe



## Polycarbonate Plate Covers

- Clear covers for easy viewing of food
- Highly heat- and break-resistant
- 1960 and 1992 also fit European “pin-fired” footless style plates for secure stacking
- Can be used in heated carts or under heat lamps up to 212°F
- Dishwasher safe



Prod No	Description	Color	Pack
<b>Polyglass Plate Covers</b>			
91020 $\Delta$	8.75" – 9.13" Polyglass Cover	202	12 ea
91040 $\Delta^*$	9.5" – 10" Polyglass Cover	202	12 ea
91055 $\Delta$	10.13" – 10.5" Polyglass Cover	202	12 ea
91070 $\Delta$	10.25" – 10.63" Polyglass Cover	202	12 ea
91065 $\Delta$	10.13" – 10.38" Polyglass Cover	202	12 ea
91080 $\Delta$	10.5" – 10.75" Polyglass Cover	202, 203	12 ea
91075 $\Delta$	10.63" – 10.69" Polyglass Cover	202	12 ea
91085 $\Delta$	11" – 11.25" Polyglass Cover	202	12 ea
91090 $\Delta$	11.75" – 12" Polyglass Cover	202	12 ea
91095 $\Delta$	12" – 12.25" Polyglass Cover	202	12 ea
<b>Polycarbonate Plate Covers</b>			
1900 $\blacklozenge$	8.69" to 9.13" PC Cover	07	12 ea
1960 $\blacklozenge$	9" Combination "Pin-Fired" Plate & Bowl PC Cover	07	12 ea
1965 $\blacklozenge$	9.44" to 9.75" PC Cover	07	12 ea
1987 $\blacklozenge$	9.81" to 10" PC Cover	07	12 ea
1989 $\blacklozenge$	10.81" to 10.25" PC Cover	07	12 ea
1991 $\Delta \blacklozenge$	10.5" to 10.63" PC Cover	07	12 ea
1992 $\Delta \blacklozenge$	10.5" to 10.63" "Pin-Fired" PC Cover	07	12 ea
1993 $\blacklozenge$	10.75" to 11" PC Cover	07	12 ea
1994 $\blacklozenge$	12" PC Cover	07	12 ea

NSF Listed products are designated with a  $\Delta$  and may be prefixed with an N

\* Item available by special order only

$\blacklozenge$  California Residents: Bisphenol A **WARNING:** See appendix A on page 1

## Custom Acrylic Plate Covers

- Excellent for keeping food warm
- Made to order for undersized or oversized plates and platters
- Use for table service or patient serving
- Dishwasher safe up to 180°F

## Custom Plate Covers

### Ordering information

- Contact your customer service representative for minimum order quantities
- Two samples of each item are required for quote
- Please allow four to six (4-6) weeks for delivery of samples
- Custom plate cover orders require customer approval of samples prior to production
- If cover has not been previously molded, additional tooling charges apply
- A size variance of 0.13" is possible in the manufacturing of this product
- Larger and smaller sizes of custom covers by special quotation only
- Custom covers are not returnable

# CUSTOMIZE



**Note: Do not use Acrylic Plate Covers in heated carts, under heat lamps, or near exposed heat sources; safe for temperatures under 130°F**



Prod No	Description	Color	Pack
<b>Custom Acrylic Clear Round Plate Covers</b>			
Group A	7" And Under Acrylic Round Cover	07	24 ea
Group B	7.06" – 8" Acrylic Round Cover	07	24 ea
Group C	8.06" – 10" Acrylic Round Cover	07	24 ea
Group D	10.06" – 14" Acrylic Round Cover	07	24 ea
Group E	14.06" – 16" Acrylic Round Cover	07	24 ea
<b>Custom Acrylic Translucent Round Plate Covers</b>			
Group AT	7" And Under Acrylic Round Cover	02	24 ea
Group BT	7.06" – 8" Acrylic Round Cover	02	24 ea
Group CT	8.06" – 10" Acrylic Round Cover	02	24 ea
Group DT	10.06" – 14" Acrylic Round Cover	02	24 ea
Group ET	14.06" – 16" Acrylic Round Cover	02	24 ea
<b>Custom Acrylic Clear Oval Plate Covers</b>			
Group P1	11" And Under Acrylic Oval Cover	07	24 ea
Group P2	11.06" – 12.5" Acrylic Oval Cover	07	24 ea
Group P3	12.56" – 14" Acrylic Oval Cover	07	24 ea
Group P4	14.06" – 16" Acrylic Oval Cover	07	24 ea
<b>Custom Acrylic Translucent Oval Plate Covers</b>			
Group P1T	11" And Under Acrylic Oval Cover	02	24 ea
Group P2T	11.06" – 12.5" Acrylic Oval Cover	02	24 ea
Group P3T	12.56" – 14" Acrylic Oval Cover	02	24 ea
Group P4T	14.06" – 16" Acrylic Oval Cover	02	24 ea

NSF Listed products are designated with a **Δ** and may be prefixed with an N



**CARLISLE**  
FOODSERVICE PRODUCTS



CLASSIC  
INVITING  
ENDURING  
BEAUTIFUL  
EYE-CATCHING  
**DRINKWARE**

---

*Carlisle offers a complete line of barware, stemware and serveware. Let us help you dress your bar and restaurant with our complete line of break-resistant beverage service products.*



# DRINKWARE

Update your barware and stemware presentation with the **sophisticated styling** and **unbeatable durability** of Alibi. An excellent choice for outdoor and poolside beverage service.

## Alibi™ Barware

- Resistant to staining, breaking and chipping
- Light-weight and durable, making it essential for special occasions and outdoor events
- Thick base on barware feels like traditional glassware
- Wide assortment of styles to choose from
- Personalize it by adding your own brand, logo, label and design; see page 334
- Promotes safety by eliminating risk of broken glass
- Barware is made of BPA free SAN
- Dishwasher safe\*



Clear(07)

Prod No	Description	Glass Rack	Color	Pack
<b>Alibi Barware</b>				
5601	1.5 oz Alibi Shot	RG49	07	24 ea
5602	2 oz Alibi Shooter	RG49	07	24 ea
5603	3 oz Alibi Shooter/Mini Dessert	RG49	07	24 ea
5609	9 oz Alibi Rocks/Juice	RG25-1, RW20	07	24 ea
5610	10 oz Alibi Hi-Ball	RG49-2	07	24 ea
5612	12 oz Alibi Double Old Fashioned	RG16-1, RW20	07	24 ea
5614	14 oz Alibi Beverage	RG25-2, RW30-1	07	24 ea
5616	16 oz Alibi Pint/Mixing	RG16-2, RW20-1	07	24 ea

\*Note: Hand washing in bar sinks or 3-compartment sinks will extend life of drinkware



## Alibi™ Stemware

- Polycarbonate material is resistant to staining, breaking and chipping
- Great for special occasions and outdoor events
- Thick base & thin stem mimics traditional glassware
- Dishwasher safe



Clear(07)

Prod No	Description	Glass Rack	Color	Pack
<b>Alibi Drinkware &amp; Stemware</b>				
5644 ♦	6 oz Alibi Champagne Flute	RG49-4	07	24 ea
5640 ♦	8 oz Alibi Champagne Flute	RG25-5, RW20-4C, RW30-4	07	24 ea
5645 ♦	8 oz Alibi White Wine	RG25-3, RG36-3, RW30-2	07	24 ea
5643 ♦	11 oz Alibi White Wine	RG16-4, RW20-3	07	24 ea
5646 ♦	9 oz Alibi Martini	RG9-3	07	24 ea
5642 ♦	20 oz Alibi Red Wine	RG16-4, RW20-3	07	24 ea
5641 ♦	22 oz Alibi Balloon	RG16-4	07	24 ea
5648 ♦	15 oz Water	RG25-3, RW20-2	07	24 ea
5649 ♦	16 oz Pilsner	RG25-5, RW20-4C, RW30-4	07	24 ea
5650 ♦	16 oz Hurricane	RG36-4, RW30-3	07	24 ea
5651 ♦	11 oz Margarita	RG9-3	07	24 ea
5652 ♦	16 oz Margarita, Grande	RG9-3	07	24 ea



# DRINKWARE

The look of recycled glass, the durability of Tritan plastic.

## Mingle

- The look and feel of recycled glass drinkware
- Tritan offers durability that withstands heavy use in your venue
- Durable Tritan is break and craze-resistant
- Stain resistant
- BPA Free
- NSF Listed; dishwasher safe
- Two-year limited warranty



Coordinating pitchers listed on page 51



RECOMMENDED GLASS RACK IS LISTED IN THE PRODUCT CHART

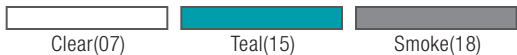

Prod No	Description	Glass Rack	Color	Pack
<b>Mingle Drinkware</b>				
MIN5441 $\Delta$	6 oz Juice Cup	RG49-1	07, 15, 18	12 ea
MIN5440 $\Delta$	14 oz Double Old Fashioned	RG16-1, RW20	07, 15, 18	12 ea
MIN5442 $\Delta$	19 oz Highball	RG16-2, RW20-1	07, 15, 18	12 ea
MIN5449 $\Delta$	22 oz High Ball	RG16-3, RW20-2	07	12 ea

NSF Listed products are designated with a  $\Delta$  and may be prefixed with an N



# SAN TUMBLERS

Carlisle leads the industry in **durable SAN Tumblers**. The variety of sizes, finishes and decorating opportunities are sure to **satisfy all of your tumbler needs**.

## Stackable

- Durable SAN reduces breakage
- Tapered sides make tumblers easy to stack
- Interior lugs prevent jamming when stored
- Textured exterior hides wear and tear
- Custom decorating available; see page 334
- BPA free
- NSF Listed; dishwasher safe

**Note: Please specify case pack when ordering**



Prod No	Description	Disposable Lid	Glass Rack	Color	Pack
<b>SAN – Large Packs</b>					
5501 $\Delta$	5 oz SAN Stackable Tumbler	DX1193ST8714*	RG49-1	07, 10, 13, 47, 54	72 ea
5526 $\Delta$	8 oz SAN Stackable Tumbler	DX1191ST8714*	RG36-1	07, 10, 13, 47, 54	72 ea
5529 $\Delta$	9 oz Old Fashioned SAN Stackable Tumbler	DXTT58*	RG25-1, RW20	07, 13	72 ea
5506 $\Delta$	9.5 oz SAN Stackable Tumbler	5506L	RG25-1, RG36-1, RW30	07, 10, 13, 47, 54	72 ea
5212 $\Delta$	12 oz SAN Stackable Tumbler	5212L	RG25-2, RW20-1, RW30-1	07, 10, 13, 47, 54	72 ea
5216 $\Delta$	16 oz SAN Stackable Tumbler	DXTT58*	RG25-2, RW20-1	07, 10, 13, 47, 54	72 ea
5220 $\Delta$	20 oz SAN Stackable Tumbler	DX30008714*	RG16-3, RW20-2	07, 10, 13, 47, 54	72 ea
5224 $\Delta$	24 oz SAN Stackable Tumbler	DXTT45*	RG16-3, RW20-2	07, 10, 13	72 ea
5232 $\Delta$	32 oz Tall SAN Stackable Tumbler	—	RG16-4	07, 10	24 ea
5532 $\Delta$	32 oz SAN Stackable Tumbler	—	RG16-3	07, 10, 13	48 ea
43937 $\Delta$	5.5 oz Low Profile SAN Stackable Tumbler	—	RG16, RW20	07	72 ea
<b>SAN – Small Packs</b>					
5501-2 $\Delta$	5 oz SAN Stackable Tumbler	DX1193ST8714*	RG49-1	07	24 ea
5526-2 $\Delta$	8 oz SAN Stackable Tumbler	—	RG36-1	07	24 ea
5529-2 $\Delta$	9 oz Old Fashioned SAN Stackable Tumbler	DXTT58*	RG25-1, RW20	07	24 ea
5532-2 $\Delta$	32 oz SAN Stackable Tumbler	—	RG16-3	07**	24 ea
5506-2 $\Delta$	9.5 oz SAN Stackable Tumbler	5506L	RG25-1, RG36-1, RW30	07	24 ea
5212-2 $\Delta$	12 oz SAN Stackable Tumbler	5212L	RG25-2, RW20-1, RW30-1	07	24 ea
5216-2 $\Delta$	16 oz SAN Stackable Tumbler	DXTT58*	RG25-2, RW20-1	07	24 ea
5220-2 $\Delta$	20 oz SAN Stackable Tumbler	DX30008714*	RG16-3, RW20-2	07	24 ea

NSF Listed products are designated with a  $\Delta$  and may be prefixed with an N

Note: \*The DX Series Disposable Lids listed above are available through our Dinx Catalog

\*\*Color available by special order only

# SAN TUMBLERS

## Genuine Coca-Cola® & Pepsi® Stackable Tumblers

- Same features as our regular SAN Stackable Tumblers
- Printed with the famous Coca-Cola® or Pepsi® trademark
- BPA free

Items are Trademarked by the Coca-Cola® Company. Coca-Cola® Stackable Tumblers are available for distribution only to authorized Coca-Cola® fountain customers for commercial foodservice use. Coca-Cola® Stackable Tumblers cannot be used for retail sale to the public.

Items are Trademarked by Pepsico®. Pepsico® Stackable Tumblers are available for distribution only to authorized Pepsico® fountain customers for commercial foodservice use. Pepsico® Stackable Tumblers cannot be used for retail sale to the public.



Prod No	Description	Disposable Lid	Glass Rack	Pack
<b>Coca-Cola Stackable Tumblers</b>				
52163550E	16 oz Coca-Cola Tumbler, Clear	DXTT58*	RG25-2, RW20-1	72 ea
52203550A	20 oz Coca-Cola Tumbler, Clear	DX30008714*	RG16-3, RW20-2	72 ea
52243550G	24 oz Coca-Cola Tumbler, Clear	DXTT45*	RG16-3, RW20-2	72 ea
5232-63550J	32 oz Coca-Cola Tumbler, Clear	—	RG16-4	72 ea
52163550D	16 oz Coca-Cola Tumbler, Ruby	DXTT58*	RG25-2, RW20-1	72 ea
52203550	20 oz Coca-Cola Tumbler, Ruby	DX30008714*	RG16-3, RW20-2	72 ea
52243550H	24 oz Coca-Cola Tumbler, Ruby	DXTT45*	RG16-3, RW20-2	72 ea
5232-63550I	32 oz Coca-Cola Tumbler, Ruby	—	RG16-3	72 ea
<b>Pepsi Stackable Tumblers</b>				
5216841C2	16 oz Pepsi Clear Script	DXTT58*	RG25-2, RW20-1	72 ea.
52163841A	16 oz Pepsi Ice Blue Script	DXTT58*	RG25-2, RW20-1	72 ea.
52163841F	16 oz Pepsi Royal Blue Script	DXTT58*	RG25-2, RW20-1	72 ea.
5216C203	16 oz Pepsi Clear Globe	DXTT58*	RG25-2, RW20-1	72 ea.
5216RB203	16 oz Pepsi Royal Blue Globe	DXTT58*	RG25-2, RW20-1	72 ea.
5216B203	16 oz Pepsi Ice Blue Globe	DXTT58*	RG25-2, RW20-1	72 ea.
5220841C2	20 oz Pepsi Clear Script	DX30008714*	RG16-3, RW20-2	72 ea.
52203841B	20 oz Pepsi Ice Blue Script	DX30008714*	RG16-3, RW20-2	72 ea.
52203841G	20 oz Pepsi Royal Blue Script	DX30008714*	RG16-3, RW20-2	72 ea.
5220C203	20 oz Pepsi Clear Globe	DX30008714*	RG16-3, RW20-2	72 ea.
5220RB203	20 oz Pepsi Royal Blue Globe	DX30008714*	RG16-3, RW20-2	72 ea.
5220IB203	20 oz Pepsi Ice Blue Globe	DX30008714*	RG16-3, RW20-2	72 ea.
5224841C2	24 oz Pepsi Clear Script	DXTT45*	RG16-3, RW20-2	72 ea.
52243841C	24 oz Pepsi Ice Blue Script	DXTT45*	RG16-3, RW20-2	72 ea.
52243841H	24 oz Pepsi Royal Blue Script	DXTT45*	RG16-3, RW20-2	72 ea.
5224C203	24 oz Pepsi Clear Globe	DXTT45*	RG16-3, RW20-2	72 ea.
5224RB203	24 oz Pepsi Royal Blue Globe	DXTT45*	RG16-3, RW20-2	72 ea.
5224B203	24 oz Pepsi Ice Blue Globe	DXTT45*	RG16-3, RW20-2	72 ea.
5232841C2	32 oz Pepsi Clear Script	—	RG16-3	24 ea.
52323841I	32 oz Pepsi Royal Blue Script	—	RG16-3	24 ea.
5232C203	32 oz Pepsi Clear Globe	—	RG16-3	24 ea.
5232RB203	32 oz Pepsi Royal Blue Globe	—	RG16-3	24 ea.
5232IB243	32 oz Pepsi Ice Blue Globe	—	RG16-3	24 ea.

Note: \*The DX Series Disposable Lids listed above are available through our Dinx Catalog

Enjoy the **timeless shape** of Louis Tumblers. Perfect for service where breakage is a concern. **Well balanced with the feel of heavy glass.**



RECOMMENDED GLASS RACK IS LISTED IN THE PRODUCT CHART

### Louis™

- Faceted shape offers easy grip
- Appearance of glass
- Made of break-resistant SAN
- Stackable space saving feature
- Custom decorating available; see page 334
- BPA free
- NSF Listed; dishwasher safe



An attractive, classic tumbler collection. **Perfect for healthcare and hospitals.**

### Lorraine™

- Attractive panel and facet design
- Made of break-resistant SAN
- 43649—9 oz Old Fashioned is designed for healthcare tray service, bar or room service
- 43647—6 oz size meets healthcare portion standards
- Stacking lugs prevent jamming
- BPA free
- Dishwasher safe

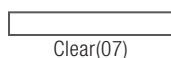

Prod No	Description	Disposable Lid	Glass Rack	Color	Pack
<b>Louis SAN Tumblers</b>					
5806 $\Delta$	6 oz Louis Tumbler	DX11968714*	RG25-1, RG36-1, RW30	07	24 ea
5808 $\Delta$	8 oz Louis Rocks	DX22259000*	RG25-1, RW20	07	24 ea
5810 $\Delta$	10 oz Louis Tumbler	5810L	RG25-1, RW30	07	24 ea
5812 $\Delta$	12 oz Louis Rocks	5812L	RG16-1, RW20	07	24 ea
5814 $\Delta$	14 oz Louis Tumbler	DXTT501*	RG25-2, RW20-1, RW30-1	07	24 ea
5816 $\Delta$	16 oz Louis Tumbler	DXTT58*	RG25-2, RW20-1	07	24 ea
5818 $\Delta$	18 oz Louis Tumbler	DXTT58*	RG25-3, RW20-2	07	24 ea
5820 $\Delta$	20 oz Louis Tumbler	—	RG16-3, RW20-2	07	24 ea
5822 $\Delta$	22 oz Louis Tumbler	5822L	RG16-3, RW20-2	07	24 ea
5832 $\Delta$	32 oz Louis Tumbler	—	RG16-3	07	24 ea
<b>Lorraine SAN Tumblers</b>					
43647	6 oz Lorraine Tumbler	—	RG36-1, RW30	07	24 ea
43648	8 oz Lorraine Tumbler	1110L	RG25-1, RW30	07	24 ea
43649	9 oz Lorraine Old Fashioned Tumbler	DXTT59*	RG16-1, RW20	07	24 ea
43651	12 oz Lorraine Tumbler	—	RG25-2, RW20-1	07	24 ea
43653	16 oz Lorraine Tumbler	DX30008714*	RG16-2, RW20-1	07	24 ea
43655	22 oz Lorraine Tumbler	—	RG16-3	07	24 ea

NSF Listed products are designated with a  $\Delta$  and may be prefixed with an N  
 Note: \*The DX Series Disposable Lids listed above are available through the Carlisle | Dinex Catalog

# SAN TUMBLERS

Bistro's **classic design works everywhere** from trendy restaurants to small town diners. Bistro never goes out of style.

## Bistro™

- Attractive traditional fluted exterior
- Interior lugs prevent jamming when stored
- Made of break-resistant SAN
- BPA free
- Dishwasher safe



The perfect stacking tumbler to use in healthcare and other **situations where a better grip is helpful.**

## Crystalon® Stack-All®

- Stylish, ribbed texture offers better grip
- Made of break-resistant SAN
- Stacking lugs prevent jamming when stored
- Crystalon RimGlow™ also available, see page 45
- BPA free
- Dishwasher safe

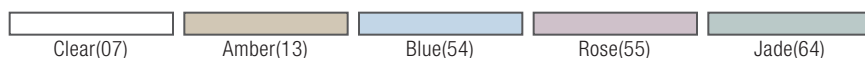

Prod No	Description	Disposable Lid	Glass Rack	Color	Pack
<b>Bistro SAN Tumblers</b>					
1104	4 oz Bistro Tumbler	—	RG49-1	07	144 ea
1105	5 oz Bistro Tumbler	DX11928714*	RG49-1	07	144 ea
1108	8 oz Bistro Tumbler	—	RG36-1, RW30	07	72 ea
1110	10 oz Bistro Tumbler	1110L	RG25-1, RW30	07	72 ea
1112	12 oz Bistro Tumbler	DX11808714*	RG25-2, RW30-1	07	72 ea
1116	16 oz Bistro Tumbler	—	RG25-2, RW20-1	07	72 ea
0120	20 oz Bistro Tumbler	DX21259000*	RG16-3, RG25-3, RW20-2	07	72 ea
0132	32 oz Bistro Tumbler	—	RG16-3	07	48 ea
<b>Crystalon SAN Stack-All Tumblers</b>					
4008	8 oz Crystalon SAN Tumbler	DX1198ST8714*	RG25-1, RW30	07, 55	48 ea
4029	9 oz Old Fashioned Crystalon SAN Tumbler	DX21259000*	RG25, RW20	07, 55**, 64	48 ea
4010	9.5 oz Crystalon SAN Tumbler	—	RG25-1, RW30	07, 54	48 ea
4012	12 oz Crystalon SAN Tumbler	5212L	RG25-2, RW20-1	07, 13, 54, 55, 64	48 ea
4016	16 oz Crystalon SAN Tumbler	DXTT58*	RG25-2, RW20-1	07, 13, 54, 55, 64	48 ea
4020	20 oz Crystalon SAN Tumbler	—	RG16-2, RW20-1	07, 13, 54, 55, 64	48 ea

\*The DX Series Disposable Lids listed above are available through the Carlisle | Dinex Catalog

\*\*Color available by special order only

## Genuine Coca-Cola® Tumbler

- Classic shape with the appearance of glass
- Dishwasher safe; stackable
- Available in clear with Coca-Cola® logo
- Break-resistant
- BPA free SAN

These items are Trademarked by the Coca-Cola® Company. Coca-Cola® Stackable Tumblers are available for distribution only to authorized Coca-Cola® fountain customers for commercial foodservice use. Coca-Cola® Stackable Tumblers cannot be used for retail sale to the public.



The tried and true diner tumblers continue to delight customers around the world.

## Pebble Optic™

- Attractive pebbled exterior hides scratches
- Thick-walled SAN construction offers sturdy feel
- 5 oz, 8 oz, 9.5 oz and 12 oz sizes have stacking feature on bottom
- BPA free
- Dishwasher safe



Prod No	Description	Disposable Lid	Glass Rack	Color	Pack
<b>Genuine Coca-Cola Tumbler</b>					
439945200	24 oz Coca-Cola Tumbler with Logo		RTP	—	72 ea
<b>Pebble Optic Tumblers</b>					
5505	5 oz Pebble Optic Tumbler	DX24019000*	RG49-1	07	24 ea
5508	8 oz Pebble Optic Tumbler	—	RG36-1	07	24 ea
5509	9.5 oz Pebble Optic Tumbler	—	RG25-1, RW30	07, 10**, 18	24 ea
5512	12 oz Pebble Optic Tumbler	DX1198ST8714*	RG36-2, RW30-1	07, 10, 18	24 ea
5517	16 oz Pebble Optic Tumbler	—	RG25-2, RW20-1, RW30-1	07, 10, 18	24 ea
5519	20 oz Pebble Optic Tumbler	DX11948714	RG25-3, RW20-2, RW30-2	07	24 ea

Note: \*The DX Series Disposable Lids listed above are available through our Dinox Catalog

\*\*Color available by special order only



# POLYCARBONATE DRINKWARE

**A classic barware line.** Trusted by pool management to **delight customers without the worry of breakage.**

## Liberty™

- Serve poolside drinks without the breakage worries of glass
- Liberty polycarbonate eliminates the need to sacrifice your presentation with disposables
- Custom decorating available; see page 334
- Dishwasher safe



Clear(07)

Prod No	Description	Glass Rack	Color	Pack
<b>Liberty Drinkware</b>				
43628 ♦	8 oz Liberty Old Fashioned	RG25-1, RW30	07	48 ea
43625 ♦	18 oz Liberty Double Old Fashioned	RG16-2, RW20-1	07	24 ea
43626 ♦	22 oz Liberty Hi-Ball	RG16-3, RW20-2	07	24 ea
43623 ♦	15 oz Liberty Pilsner	RG25-4, RW20-3	07	24 ea
43624 ♦	9.5 oz Liberty Margarita	RG9-3	07	24 ea
43627 ♦	8 oz Liberty Martini	RG16-3, RG9-3	07	24 ea
43629 ♦	9 oz Liberty Cocktail	RG25-3, RW20-2	07	24 ea
43620 ♦	5 oz Liberty Champagne Flute	RG25-4, RW20-3	07	24 ea
43631 ♦	15 oz Liberty Hurricane	RG25-4, RW20-3	07	24 ea
43630 ♦	13 oz Liberty Cocktail	RG25-3, RW20-2	07	24 ea
43621 ♦	10.5 oz Liberty White Wine	RG16-3, RG25-3, RW20-2	07	24 ea
43622 ♦	13.5 oz Liberty Goblet	RG16-3, RW20-2	07	24 ea

♦ California Residents: Bisphenol A **WARNING:** See appendix A on page 1

# POLYCARBONATE TUMBLERS

A **fun color grouping** that is a perfect look for poolside or barbeques where breakage is a concern.

## Crystalon® RimGlow™

- Tumblers change hue and intensity with variations in lighting, perspective and beverage color
- Mix and match colors in brilliant, long-lasting polycarbonate
- Coordinates with Caribbean color dinnerware shown in the Dinnerware section of this catalog
- Crystalon Stack-All® also available, see page 42
- Dishwasher safe



4035

## Stackable

- Ideal for prisons, schools and high-volume chains
- Extremely break-resistant polycarbonate extends tumbler life
- Dishwasher safe



RECOMMENDED GLASS RACK IS LISTED IN THE PRODUCT CHART



5120

5116-2

5108-2

5105-2



Prod No	Description	Disposable Lid	Glass Rack	Color	Pack
<b>Crystalon Polycarbonate RimGlow Tumblers</b>					
4033 ♦	12 oz Crystalon PC Tumbler	5212L	RG25-2, RW20-1, RW30-1	09, 14, 22**	48 ea
4034 ♦	16 oz Crystalon PC Tumbler	DXTT58*	RG25-2, RW20-1	07, 09, 14, 22**	48 ea
4035 ♦	20 oz Crystalon PC Tumbler	—	RG16-2, RG16-3, RW20-1, RW20-2	09, 14, 22	48 ea
<b>Polycarbonate Stackable Tumblers</b>					
5105-2 ♦	5 oz PC Stackable Tumbler	DX1193ST8714*	RG16, RW20	07	24 ea
5108-2 ♦	8 oz PC Stackable Tumbler	—	RG36-1	07	24 ea
5109-2 ♦	9.5 oz PC Stackable Tumbler	5109L	RG25-1, RG36-1, RW30	07	24 ea
5116-2 ♦	16.5 oz PC Stackable Tumbler	DX22259000*	RG25-2, RW20-1	07, 10	24 ea
5120 ♦	20 oz PC Stackable Tumbler	DX30008714*	RG25-3, RW20-2	07	24 ea

\*The DX Series Disposable Lids listed above are available through the Carlisle | DineX Catalog

\*\*Color available by special order only

♦ California Residents: Bisphenol A **WARNING:** See appendix A on page 1

# POLYCARBONATE TUMBLERS

Another classic design from Carlisle. **Six sizes available for all of your bar needs.**

## Lafayette®

- Distinctive fluted pattern has the look and style of glass
- Perfect for bar service, room service, or catered events
- Stacking lugs prevent jamming
- Slotted base allows complete draining
- Dishwasher safe



## Swirl

- Unique swirl design creates a perfect, glass-like tabletop beverage presentation
- Dishwasher safe



RECOMMENDED GLASS RACK IS LISTED IN THE PRODUCT CHART

Clear(07)

Prod No	Description	Disposable Lid	Glass Rack	Color	Pack
<b>Lafayette Polycarbonate Tumblers</b>					
43633 ♦	8 oz Lafayette PC Tumbler	DX20029000*	RG36-1, RW30	07	36 ea
43635 ♦	10 oz Lafayette PC Tumbler	—	RG25-2, RW30-1	07	36 ea
43636 ♦	12 oz Lafayette PC Tumbler	—	RG25-2, RW20-1, RW30-1	07	36 ea
43637 ♦**	12 oz Lafayette PC Old Fashioned Tumbler	DX21259000*	RG16-1, RG25-1, RW20	07	36 ea
43638 ♦	16 oz Lafayette PC Tumbler	DX21259000*	RG25-2, RW20-1	07	36 ea
43640 ♦	22 oz Lafayette PC Tumbler	—	RG16-3, RW20-2	07	36 ea
<b>Swirl Polycarbonate Tumblers</b>					
43662 ♦	5 oz Swirl PC Tumbler	—	RG49-1	07	36 ea
43663 ♦	8 oz Swirl PC Tumbler	DX20029000*	RG36-1, RW30	07	36 ea
43664 ♦	9 oz Swirl PC Tumbler	—	RG25-1, RW20	07	36 ea
43665 ♦	10 oz Swirl PC Tumbler	—	RG25-2, RW30-1	07	36 ea
43666 ♦	12 oz Swirl PC Tumbler	—	RG25-2, RW20-1, RW30-1	07	36 ea
43668 ♦	16 oz Swirl PC Tumbler	—	RG16-2, RG25-2, RW20-1	07	36 ea
43674 ♦	22 oz Swirl PC Tumbler	—	RG16-3, RW20-2	07	36 ea

Note: \*The DX Series Disposable Lids listed above are available through the Carlisle | Dinx Catalog

♦ California Residents: Bisphenol A **WARNING:** See appendix A on page 4

\*\* Item available by special order only



# CARAFES & MUGS

**Stylish** design makes **Cascata** Carafes the most **attractive** carafe you can choose for tabletops and buffets, while offering **convenience** and superior **functionality**.

## Cascata Carafe

- Ergonomic shape is easy to hold and angled rim provides a drip-free pour
- Larger sizes can be used for water, juice or wine
- Smaller sizes are good for salad dressings, syrups, single-portion drinks and snack mix
- A green alternative to single-serve drinks
- Snap-on lids available in solid or hinged styles and fit .5, 1 and 1.5 Liter Carafes
- All sizes have capacity marks for portion control
- Durable polycarbonate looks like glass
- NSF Listed; dishwasher safe



Snap-on lids available in solid or hinged styles

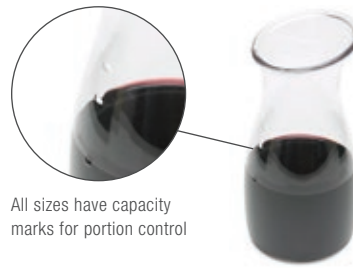

All sizes have capacity marks for portion control



70900

70902 with 70905 Lid

70903

70901 with 70904 Lid



7000

## 2 Cup Carafe

- Durable SAN 11 oz capacity carafe is perfect for room service, hospitals, nursing homes, restaurants and cafeterias
- Ribbed neck and textured finish provide a better grip and greater safety than glass bottles
- BPA free
- Dishwasher safe



Prod No	Description	Capacity Marks	Glass Rack	Color	Pack
<b>Cascata Carafes &amp; Lids</b>					
70900 $\Delta$ ♦	0.25 Liter Carafe	6 oz, 8 oz, 0.25L	RG25-2, RW30-1	07	12 ea
70901 $\Delta$ ♦	0.50 Liter Carafe	0.5L	RG16-3, RW20-2	07	12 ea
70902 $\Delta$ ♦	1 Liter Carafe	1.0L	RG16-5	07	12 ea
70903 $\Delta$ ♦	1.5 Liter Carafe	1.5L	—	07	12 ea
70904 $\Delta$	Flat Carafe Lid (fits 70901, 70902, 70903)	—	—	02	12 ea
70905 $\Delta$	Hinged Carafe Lid (fits 70901, 70902, 70903)	—	—	02	12 ea
<b>2 Cup Carafe</b>		<b>Disposable Lid</b>			
7000	11 oz Carafe	DX55-57*	RG16-2	07	36 ea

NSF Listed products are designated with a  $\Delta$  and may be prefixed with an N

Note: \*The DX Series Disposable Lids listed above are available through the Carlisle | Dinex Catalog

♦ California Residents: Bisphenol A **WARNING:** See appendix A on page 1

# MUGS

## Lexington™ Polycarbonate Mug

- Heavy-weight mug offers traditional styling in durable polycarbonate
- Crystal clear mug has the look and feel of glass without the replacement
- Recessed drain for easy drying
- Dishwasher safe



43965

## Carlisle Mugs

- Made of break-resistant, BPA free Tritan
- Specially designed, large handle allows for easy holding, keeps fingers away from hot liquids
- Available in 6 colors to coordinate with Carlisle's existing dinnerware lines
- Safe for temperatures up to 190°F (88°C)
- Custom decorating available; see page 334
- NSF Listed; dishwasher safe



43068

43066



## Coffee Mugs

- Rugged, chip- and crack-resistant plastic to give you long-wearing service
- Diablo mugs have double-wall construction to maintain hot temperatures longer
- Diablo II has single-wall construction for money-saving service
- All mugs are dishwasher safe



8004

8104

4512

Customized mugs help promote your company or services. Contact Customer Service at 1-800-654-8210 for imprinting information.

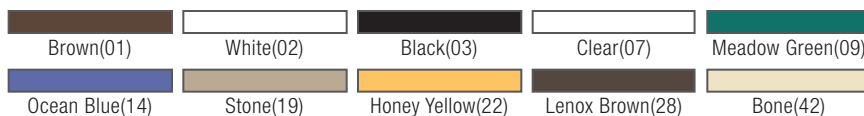

Prod No	Description	Disposable Lid	Glass Rack	Color	Pack
<b>Lexington Polycarbonate Mug</b>					
43965 ♦	16 oz Lexington Mug	—	RG9-3	07	12 ea
<b>Carlisle Mugs</b>					
43066	8 oz Carlisle Mug	5109L	RG16-1	02, 03, 09, 14, 22, 42	12 ea
43068	12 oz Carlisle Mug	—	RG25-1, RW20	02, 03, 09, 14, 22, 42	12 ea
<b>Coffee Mugs</b>					
8004 ♦	8 oz, 4.13" Diablo Mug with White Liner	—	RG16-1	01, 02	36 ea
8104	8 oz, 4.13" Diablo II Mug	—	RG16-1	01	36 ea
4512 ♦	12 oz, 5.5" Jumbo Soup/Latté Mug	—	RG9, RTP	19, 28	24 ea

Note: \*The DX Series Disposable Lids listed above are available through the Carlisle | DineX Catalog

♦ California Residents: Bisphenol A **WARNING:** See appendix A on page 1

# PITCHERS

Carlisle offers the perfect selection of break-resistant pitchers. **They are an industry favorite.**

## VersaPour® Pitchers

- Lip design allows for easy pouring with ice from front or either side without splashing
- Sure grip ergonomic handle and thumb grip help control pouring
- Made of break-resistant polycarbonate for ultimate durability
- Thinner wall provides optimum strength and durability; reduces wait staff's wrist stress
- 5544 Window Pitcher provides a smooth surface for printing your logo; accommodates up to 2.88" wide by 2" tall image
- Custom decorating available; see page 334
- 5546 and 5547 are made of BPA free SAN
- NSF Listed; dishwasher safe

VersaPour's specially contoured lip design allows for easy pouring with ice from front or sides without splashing



## Polycarbonate Pitchers

- Ice trap retains ice or beer foam
- Made of break-resistant polycarbonate for ultimate durability
- NSF Listed; dishwasher safe



Prod No	Description	Color	Pack
<b>VersaPour Polycarbonate Pitchers</b>			
5540 Δ ♦	60 oz VersaPour Pitcher	07, 13	6 ea
5544 Δ ♦	60 oz VersaPour Window Pitcher	07	6 ea
<b>VersaPour SAN Pitchers</b>			
5546 Δ	60 oz VersaPour Pitcher	07	6 ea
5547 Δ	60 oz VersaPour Window Pitcher	07	6 ea
<b>Polycarbonate Pitchers</b>			
5536 Δ ♦	32 oz Polycarbonate Pitcher	07	6 ea
5538 Δ ♦	48 oz Polycarbonate Pitcher	07	6 ea

NSF Listed products are designated with a Δ and may be prefixed with an N  
 ♦ California Residents: Bisphenol A **WARNING:** See appendix A on page 1



# PITCHERS

## Crystalite® Polycarbonate Pitchers

- Tapered lip permits controlled pouring of the beverage and ice
- Secure thumb hold on handle aids control of pitcher while pouring
- Slot at skirt base deters water collection
- Made of break-resistant polycarbonate for ultimate durability
- NSF Listed; dishwasher safe



## Élan™ Polycarbonate Pitcher

- Thick walls and optic bottom gives these pitchers the look of glass
- Made of break-resistant polycarbonate
- Lid available separately
- Dishwasher safe



Clear(07)

Prod No	Description	Glass Rack	Color	Pack
<b>Crystalite Polycarbonate Pitchers</b>				
5583 Δ ♦	48 oz Crystalite Pitcher	RF	07	6 ea
5587 Δ ♦	60 oz Crystalite Pitcher	RF	07	6 ea
<b>Élan Polycarbonate Pitcher &amp; Lid</b>				
5570 ♦	58 oz Élan Pitcher	RF	07	6 ea
5573 ♦	Clear Lid for Élan Pitcher	—	07	6 ea

NSF Listed products are designated with a Δ and may be prefixed with an N

♦ California Residents: Bisphenol A **WARNING:** See appendix A on page 1

**The look of recycled glass, the durability of Tritan plastic.**

**Mingle**

- The look and feel of recycled glass drinkware
- Tritan offers durability that withstands the heavy use in your venue
- Durable Tritan is break and craze-resistant
- Stain resistant
- BPA Free
- NSF Listed; dishwasher safe
- Two-year limited warranty



**Coordinating drinkware page 38**

**Stainless Steel Pitchers**

- The look of silver, with the durability of stainless steel
- 18-8 stainless steel with mirror-polished finish
- Contoured lip to help control flow and prevent drips
- Hollow tubular handle
- Handwashing recommended



Prod No	Description	Glass Rack	Color	Pack
<b>Mingle Pitcher</b>				
MIN5443 $\Delta$	74 oz Pitcher	—	02, 15, 18	4 ea
<b>Stainless Steel Pitchers</b>				
609270	2 qt Stainless Steel Bell Pitcher	RTP	—	1 ea
609273	3 qt Stainless Steel Bell Pitcher	RTP	—	1 ea

NSF Listed products are designated with a  $\Delta$  and may be prefixed with an N



# DISPOSABLE LIDS

## Lids

- Carlisle Disposable Lids are a green solution that saves you money
- Lower your disposable costs when you replace your disposable kid's cups with reusable Carlisle Tumblers and Disposable Lids
- Snug fitting lids fit a variety of Carlisle Tumblers and are slotted for use with straws
- Use for room service applications or anywhere you want to avoid spills
- Lids are packed 1,000 per case



In addition to the disposable lids listed here, Carlisle | Dinex offers a large selection of disposable lids for Carlisle and non-Carlisle tumblers. See our Dinex catalog at [www.dinex.com](http://www.dinex.com) for a complete listing, or contact your local Dinex sales representative for more information.



Translucent(30)

Prod No	Description	Color	Pack
<b>Disposable Lids</b>			
5810L	Fits 10 oz Louis Tumbler 5810	30	1 cs
5812L	Fits 12 oz Louis Tumbler 5812	30	1 cs
5822L	Fits 22 oz Louis Tumbler 5822	30	1 cs
5212L	Fits 12 oz Stackable Tumbler 5212, 12 oz Crystalon SAN Tumbler 4012 and 12 oz Crystalon PC Tumbler 4033	30	1 cs
5109L	Fits 9.5 oz Stackable PC Tumbler 5109, 8 oz Carlisle Mug 43066	30	1 cs
5506L	Fits 9.5 oz Stackable Tumbler 5506	30	1 cs
1110L	Fits 10 oz Bistro Tumbler 1110 and 8 oz Lorraine Tumbler 43648	30	1 cs
63910L	Fits 10 oz Cambro® Tumbler NT10*	30	1 cs
63912L	Fits 12 oz Cambro® Tumbler NT12*	30	1 cs
52412L	Fits 12 oz Cambro® Tumbler LT12*	30	1 cs

\*Cambro® is a registered trademark of Cambro® Manufacturing Company; Carlisle is not associated in any way with Cambro® Manufacturing Company



**CARLISLE**  
FOODSERVICE PRODUCTS



PRACTICAL  
RUGGED  
STYLISH  
UNIQUE  
**TABLETOP  
ACCESSORIES**



---

*Complete your tabletop setting in style with  
Carlisle's versatile accessories offering.*





# RAMEKINS

Carlisle has a ramekin for every application. Ramekins are offered in **high-quality melamine** designed to last. **The perfect addition to your hardworking tableware.**

## Straight Sided Ramekins

- Melamine ramekins are safe for temperatures up to 212°F
- A modern take on a traditional product
- Use for sauces, condiments and mini desserts
- Ramekins stack for easy storage and space savings
- NSF Listed; dishwasher safe



## Oval Ramekins

- Heavy-weight melamine ramekins are perfect for sauces, condiments, finger foods, mini desserts, etc.
- Oval shape is great for pouring dressings and sauces
- Wide design makes dipping easier
- NSF Listed; dishwasher safe



## Square Melamine Ramekins

- Made of sturdy, break-resistant melamine
- 2 oz square ramekins available in single and double sizes
- Ramekins are stackable and can be used as a set for a variety of dipping sauces or individually for soy sauce and other condiments
- Safe for temperatures up to 212°F
- NSF Listed; dishwasher safe



Prod No	Description	Color	Pack
<b>Straight Sided Ramekins</b>			
410 $\Delta$	2 oz Straight Sided Ramekin	02, 03, 42	48 ea
412 $\Delta$	3 oz Straight Sided Ramekin	02, 03, 42	48 ea
414 $\Delta$	4 oz Straight Sided Ramekin	02, 03, 42	48 ea
<b>Oval Ramekins</b>			
S310 $\Delta$	2 oz Oval Ramekin	02, 03, 42	48 ea
S312 $\Delta$	3 oz Oval Ramekin	02, 03, 42*	48 ea
S314 $\Delta$	4 oz Oval Ramekin	02*, 03, 42	48 ea
<b>Square Melamine Ramekins</b>			
0860 $\Delta$	2 oz Square Ramekin	02, 03	48 ea
0862 $\Delta$	Double 2 oz Square Ramekin	02, 03	24 ea

NSF Listed products are designated with a  $\Delta$  and may be prefixed with an N

\* Color available by special order only

## Japanese Style Ramekin

- Made of sturdy, break-resistant melamine
- 2 oz ramekins are styled with an Asian flare
- Heavy-weight design has the look and feel of ceramic or glass
- Ramekins are stackable and can be used for wasabi, ginger or a variety of dipping sauces
- Safe for temperatures up to 212°F
- NSF Listed; dishwasher safe



## Scalloped Melamine Ramekins

- Made of thick-walled, heavy-weight melamine
- Stylish design coordinates with our dinnerware and display pieces
- Serves sauces, butter, salad dressings, salsa, etc.
- NSF Listed; dishwasher safe



## Melamine Butter Dish

- Ideal for small portions of butter, wasabi or other condiments
- Wide mouth gives the illusion of a larger portion
- Heavy-weight sides have the look and feel of ceramic or glass
- Unique look is perfect for both casual and upscale dining or even pre-portioning in buffet and catering applications
- NSF Listed; dishwasher safe



Prod No	Description	Color	Pack
<b>Japanese Style Ramekin</b>			
0864 $\Delta$	2 oz Japanese Style Ramekin	02, 03	48 ea
<b>Scalloped Ramekins</b>			
43942 $\Delta$	1 oz Scalloped Ramekin	02, 03*, 42	48 ea
43943 $\Delta$	2 oz Scalloped Ramekin	02, 03, 42*	48 ea
43944 $\Delta$	3 oz Scalloped Ramekin	02, 03	48 ea
<b>Melamine Butter Dish</b>			
0855 $\Delta$	1 oz Melamine Butter Dish	02	48 ea

NSF Listed products are designated with a  $\Delta$  and may be prefixed with an N

\* Color available by special order only



# RAMEKINS

## Melamine Ramekins

- Thick-walled, heavy-weight melamine is perfect for serving sauces, butter, salad dressing, salsa, etc.
- NSF Listed; dishwasher safe



## Salsa Dishes

- Carlisle salsa dishes are available in a variety of sizes, weights and materials
- Designed to accommodate dipping large chips or appetizers
- Deep salsa bowl has 8 oz capacity, perfect for serving salsa, cheese sauce, soups and other sauces

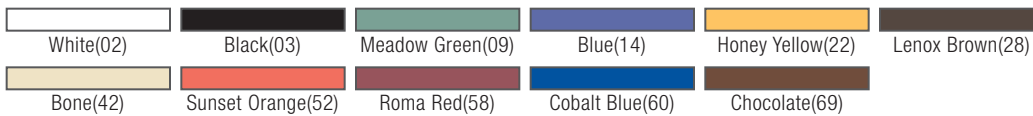

Prod No	Description	Color	Pack
<b>Melamine Ramekins</b>			
S277 Δ	1.75 oz Smooth Ramekin	42	48 ea
S275 Δ	1.5 oz Smooth Ramekin	02, 03, 09, 14, 22, 42, 52, 60	48 ea
0852 Δ	2 oz Smooth Ramekin	02, 03, 09, 14, 22, 42, 52, 58, 60, 69,	72 ea
S280 Δ	3 oz Smooth Ramekin	02, 03, 42, 52, 58, 60, 69	48 ea
S285 Δ	4 oz Smooth Ramekin	02, 03, 09, 14, 22, 42, 52, 58, 60,	48 ea
S286 Δ	6 oz Smooth Ramekin	02, 03, 42, 60, 69	48 ea
S279 Δ	2 oz Fluted Ramekin	02, 03, 42, 60	48 ea
S282 Δ	3 oz Fluted Ramekin	02, 03, 42, 60, 69	48 ea
S287 Δ	4 oz Fluted Ramekin	02, 03, 42, 60, 69	48 ea
<b>Salsa Dishes</b>			
0873 Δ	3 oz Melamine Molcajete Ramekin	03	48 ea
0878 Δ	8 oz Melamine Molcajete Ramekin	03	48 ea
43125	5 oz SAN Salsa Dish	60	48 ea
4553	8 oz Melamine Deep Salsa Bowl	28	36 ea
0875 Δ	5 oz Melamine Salsa Dish	02, 03, 42, 60	48 ea

NSF Listed products are designated with a Δ and may be prefixed with an N

## Ramekins & Sauce Cups

- Perfect for individual service of butter, salsa, condiments, sauce
- Made of durable, break-resistant SAN
- Available in four distinct styles
- 0362, 0843, 0844, 0845, 2500: NSF Listed; dishwasher safe



## Stainless Steel Ramekin & Sauce Cup

- Rust-free, 18-8 stainless provides durable, easy care service
- Dishwasher safe



## SAN Ramekins

- Economical SAN ramekins serve sauces, butter, salad dressings, salsa, etc.
- Stackable design for easier storage
- Dishwasher safe



Prod No	Description	Color	Pack
<b>Ramekins &amp; Sauce Cups</b>			
0362 $\Delta$	2.5 oz Standard Ramekin	02, 07, 28	48 ea
0843 $\Delta$	1 oz Fluted Ramekin	02	48 ea
0844 $\Delta$	2 oz Fluted Ramekin	02, 07	48 ea
0845 $\Delta$	4.5 oz Fluted Ramekin	02, 07, 28	48 ea
2500 $\Delta$	2.5 oz SAN Sauce Cup	07	72 ea
0820	2.75 oz Oyster Sauce Cup	07	144 ea
0830	1 oz Soufflé Cup	07	144 ea
0831	2.5 oz Soufflé Cup	07	144 ea
602400	1.5 oz Stainless Steel Classic Ramekin	—	144 ea
602500	2.5 oz Stainless Steel Classic Sauce Cup	—	144 ea
<b>SAN Ramekins</b>			
43121	1.5 oz Smooth Ramekin	42	48 ea
43122	2 oz Smooth Ramekin	03	48 ea
43123	3 oz Smooth Ramekin	03, 42	48 ea
43126	6 oz Smooth Ramekin	03, 42, 60	48 ea

NSF Listed products are designated with a  $\Delta$  and may be prefixed with an N



# COFFEE SERVICE

## Sugar Caddies

- Merchandiser caddy has pockets for salt and pepper shakers plus sign clip
- NSF Listed; dishwasher safe



## Creamer/Pitchers

- Stain-resistant creamers and pitchers can be used for syrup, cream, salad dressings, sauces, etc
- Easy-pour, no-drip lip design
- Made of dishwasher safe SAN; safe for temperatures from 0° to 180°F
- 4560 is NSF Listed



## Cheese Shaker/Sugar Pourer

- Popular 12 oz size is made of durable, break-resistant SAN
- Threaded lip fits standard shaker or pourer caps

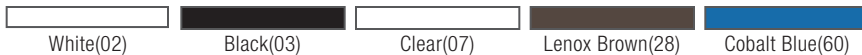

Prod No	Description	Color	Pack
<b>Caddies, Pitchers &amp; Pourers</b>			
4549 Δ	Crystalite Caddy (holds 20 packets)	07	24 ea
4550 Δ	Standard Caddy (holds 20 packets)	02, 03, 07, 28, 60	24 ea
4551 Δ	Merchandiser Caddy (holds 50 packets)	03	24 ea
4560 Δ	2 oz Syrup Pitcher/Creamer	02, 07	36 ea
4563	3 oz Creamer/Pitcher	02	36 ea
3316	Base with Pourer Top	07	36 ea
3319	Base with Shaker Top	07	36 ea

NSF Listed products are designated with a Δ and may be prefixed with an N



### J-Jars

- Durable jars are ideal for condiments of all types: jelly, jam, mustard, sauces, etc.
- Chrome-plated caddy offers beauty and strength
- NSF Listed



4575

### Bud Vases

- Let flowers add the finishing touch to any tabletop
- Beautiful, break-resistant acrylic with heavy base to prevent messy spills



Clear(07)

Prod No	Description	Color	Pack
<b>J-Jars</b>			
4575 $\Delta$	8 oz J-Jar with Lid	07	24 ea
<b>Bud Vases</b>			
4650	4" Acrylic Bud Vase	07	12 ea
4651	6" Acrylic Bud Vase	07	12 ea

NSF Listed products are designated with a  $\Delta$  and may be prefixed with an N



# SERVING BASKETS

## Woven Baskets

- Handmade natural beauty combined with easy care
- Resistant to mold and mildew
- Microwave safe
- Dishwasher safe



## Munchie Baskets™

- Excellent for serving a deli sandwich or a specialty appetizer
- Stackable and dishwasher safe
- Custom decorating available; see page 334



The industry's only basket with custom imprinting

## Basket Server

- Break-resistant SAN baskets can be used for holding tall items like bread sticks or can be used as an ice bucket for table or room service
- Safe for use in temperatures from 0° to 180°F
- Dishwasher safe



Prod No	Description	Color	Pack
<b>Woven Baskets</b>			
6550	9" x 6.25" Small Oval Basket	03, 25	6 ea
6551	11.75" x 7.75" Medium Oval Basket	03, 25	6 ea
6552	11.5" x 8.5" Rectangle Oval Basket	03, 25	6 ea
6553	9" Small Round Basket	03, 25	6 ea
<b>Munchie Baskets</b>			
44030	7.38" x 5.38" Munchie Basket	03, 05	24 ea
44031	10.38" x 8" Munchie Basket	03, 05	12 ea
<b>Basket Server</b>			
356	6.5" Basket, 3 qt	07	6 ea





## WeaveWear™ Baskets & Platter

- For serving chips, fries, sandwiches, finger foods or kids' meals
- Wicker weave pattern exterior with smooth, easy to clean interior
- Safe alternative to wicker and plastic coated wire
- Made of durable FDA grade polypropylene
- Vented base on 6528 and 6529 allows for drainage and reduces condensation
- 6528, 6527, 6529 feature a wide diameter and raised bottom design to create a unique presentation for your signature sandwich, appetizer or specialty item
- Dishwasher safe



## Wicker Look Basket

- Elegant baskets for serving chips, fries, sandwiches, finger foods or kids' meals
- Design features a detailed wicker weave patterned exterior
- Smooth, easy-to-clean interior
- Made of durable, scratch-resistant polycarbonate



## Bread & Bun Basket

- Extremely economical basket is great for all types of food such as sandwiches, fries, ribs, chips or breads



Prod No	Description	Color	Pack
<b>WeaveWear Baskets &amp; Platter</b>			
6504	9" x 6.25" Oval WeaveWear Basket	03, 05, 09, 67	12 ea
6524	9" Round WeaveWear Basket	03, 05, 09, 67	12 ea
6526	12" Round WeaveWear Basket	03, 05, 09, 67	12 ea
6528	9.25" Round WeaveWear Basket with Drain Slots	03	12 ea
6527	10.38" Round WeaveWear Platter	03, 31	12 ea
6529	11" Round WeaveWear Basket with Drain Slots	03	12 ea
<b>Wicker Look Basket</b>			
WB965 ♦	9.44" x 6.63" Oval Basket	07	6 ea
<b>Bread &amp; Bun Basket</b>			
0333	9.25" x 6" Oval Basket	03, 05	36 ea

♦ California Residents: Bisphenol A **WARNING:** See appendix A on page 1



# TORTILLA SERVERS

**Interlocking base & lid** design allows for stacking several tortilla servers at one time

## Tortilla Servers

- Lid has easy-grip, recessed handle
- Durable polycarbonate tortilla servers withstand temperatures up to 212°F
- Polypropylene servers are easy-clean, long-lasting and economical; withstand temperatures up to 190°F
- NSF Listed; dishwasher safe

US Patent No. D-331351



Salsa and Molcajete Dishes on page 58



Prod No	Description	Color	Pack
<b>Interlocking Tortilla Servers &amp; Lids</b>			
0470 ▲◆	7.5" PC Tortilla Server	03, 05, 60	24 ea
0475 ▲◆	7.5" PPY Tortilla Server	03, 05, 28, 42	24 ea

NSF Listed products are designated with a ▲ and may be prefixed with an N

◆ California Residents: Bisphenol A **WARNING:** See appendix A on page 1



## Aztec Tortilla Servers

- Unique Aztec design works well in any traditional Mexican or Tex-Mex restaurant
- 8" and 12" servers available in a lift off lid model
- 7" server available with hinged lid for easy one handed access
- Thick walled polypropylene material helps keep tortillas warm for table service
- Microwaveable, safe for temperatures up to 150°F
- Servers are stackable
- NSF Listed; dishwasher safe



Prod No	Description	Color	Pack
<b>Aztec Tortilla Servers &amp; Lids</b>			
0710 Δ	7" Hinged Tortilla Server	03, 29	12 ea
0713 Δ	8" Lift Off Tortilla Server	03, 29	12 ea
0717 Δ	12" Lift Off Tortilla Server	03, 08, 29	6 ea
0700 Δ	7" Hinged Replacement Lid	03, 29	12 ea
0703 Δ	8" Replacement Lid	03, 08	12 ea
0707 Δ	12" Replacement Lid	03, 08, 29	6 ea

NSF Listed products are designated with a Δ and may be prefixed with an N



# SERVING TRAYS & ACCESSORIES

## Round Serving Trays

- Serving Trays are perfect for bar service or individual meals including salads, sandwiches or burgers
- Perfect size for iced seafood platters
- Made of heavy-duty, break-resistant melamine
- NSF Listed; dishwasher safe



1300

## Roll-Top Covered Dishes

- Multi-purpose roll-top dishes are perfect for serving sugar, candies, sauces or dressings
- High-polish 18-8 stainless steel
- Handwashing recommended



609132

609131

609133



Prod No	Description	Color	Pack
<b>Serving Trays</b>			
1300 $\Delta$	13" x 1.5" Melamine Serving Tray	01, 02, 60	12 ea
<b>Roll-Top Covered Dishes</b>			
609131	10 oz Roll-Top Covered Dish	—	12 ea
609132	14 oz Roll-Top Covered Dish	—	12 ea
609133	30 oz Roll-Top Covered Dish	—	1 ea

NSF Listed products are designated with a  $\Delta$  and may be prefixed with an N

### Dual Booster Seats

- Two-sided seat offers a choice of heights
- Extra-strong, one-piece molded design with wide square base for better stability
- Anti-skid pads on both sides prevent sliding

### Booster Seat With Safety Strap

- Strap secures to chair to increase child safety
- Snap clasp and adjustable strap for use behind chair back or under seat



7111-4



7110

7111-4



Prod No	Description	Color	Pack
<b>Dual Booster Seat</b>			
7110	Booster Seat	01, 03, 05, 06, 08	4 ea
<b>Booster Seat with Safety Strap</b>			
7111-4	Booster Seat with Safety Strap	01, 03	4 ea
<b>Replacement Strap</b>			
7112	Replacement Strap	03	12 ea

Note: 7110, 7111-4 can ship UPS/FedEx Ground at oversize cost



**CARLISLE**  
FOODSERVICE PRODUCTS

BEAUTIFUL  
QUALITY  
ELEGANT  
PROTECTIVE  
HANDMADE  
**MARKO**  
**TABLE**  
**COVERINGS**

---

*No room is complete without the finishing touches and setting. An excellent table begins with quality products. Marko offers the finest quality of textiles to help you achieve that perfect look.*



# IN-STOCK PROGRAM

Includes the **most requested** Marko table coverings, napkins, skirting and accessories **available as stocked items**. With Carlisle FoodService, you can count on Marko to be there for you.

## Embrace™

- Polyester/Spandex fabric embraces the table providing a snug fit and eliminating wrinkles
- True four-way stretch fabric easily expands over most tables for a uniform look
- Reinforced plastic feet come standard and are sewn in to hold the cover firmly in place
- Feet protect linens from contact with rough floor surfaces and help prevent ripping and soiling
- Serving as a functional linen, Embrace is perfect for beverage dispensers and waste receptacles
- Easy to install; no pressing or dry cleaning required
- Machine washable and dryable for easy care

EMB5026HT30



EMB5026TLC23

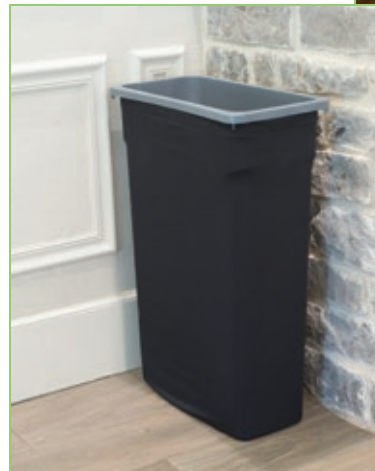

### Embrace



Black(014)

Product No	Description	Finished Size	Color	Pack
<b>Embrace</b>				
EMB5026RT830	Embrace Rectangular Cover	96" x 30" x 30"	014	1 ea
EMB5026AC830	Embrace Arch Cut Cover	96" x 30" x 30"	014	1 ea
EMB5026RT630	Embrace Rectangular Cover	72" x 30" x 30"	014	1 ea
EMB5026AC630	Embrace Arch Cut Cover	72" x 30" x 30"	014	1 ea
EMB5026R72	Embrace Round Table Cover	72"	014	1 ea
EMB5026R24	Embrace Round Table Cover	24"	014	1 ea
EMB5026HT30	Embrace Hi-Top Round Table Cover	30"	014	1 ea
EMB5026TLC23	Embrace 23 gal TrimLine Cover	—	014	1 ea
EMB5026WC35	Embrace 32 gal Waste Container Cover	—	014	1 ea
EMB5026WC44	Embrace 44 gal Waste Container Cover	—	014	1 ea
EMB5026WC55	Embrace 55 gal Waste Container Cover	—	014	1 ea
EMB5026BS10	Embrace 10 gal Beverage Server Cover	—	014	1 ea
EMB5026BS5	Embrace 5 gal Beverage Server Cover	—	014	1 ea
EMB5026BS25	Embrace 2.5 gal Beverage Server Cover	—	014	1 ea
EMB5026LTRC	Embrace Tray Stand Cover, >30"	30"+	014	1 ea
EMB5026TRC	Embrace Tray Stand Cover, <30"	30"	014	1 ea
EMB5026TT27014	Embrace Tray Cover (Fits 27" x 22" Oval Tray)	28" x 33"	014	1 ea



## SoftWeave™ Spun Filament Polyester Tablecloths & Napkins

- Spun filament polyester fabric (blend of polyspun and poly filament) provides the look and feel of cotton without fading or shrinking
- Excellent resistance to pilling and snagging
- Absorbs liquids quickly
- Advanced stain release technology allows you to wash at only 120°F water temperature and use half the detergent
- Aspen Damask, a Marko exclusive, has a high definition pattern that offers a bolder contrast



SoftWeave Tablecloth

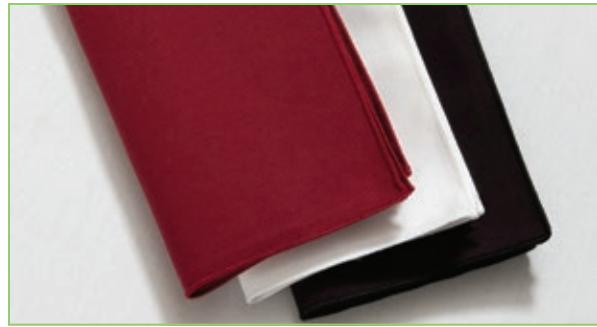

SoftWeave Napkins

### SoftWeave



White(010)

Black(014)

Burgundy(046)

### Aspen Damask

### Classic Twill

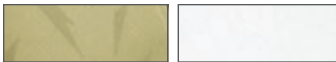

Sage(147)

White(010)

Prod No	Description	Dimensions	Color	Pack
<b>Fabric Tablecloths</b>				
53785252SM	SoftWeave Square Tablecloth	52" x 52"	010, 014, 046	1 ea
537852AITM	SoftWeave Rectangular Tablecloth	52" x 108"	010, 046	1 ea
53785454SM	SoftWeave Square Tablecloth	54" x 54"	010	1 ea
537854AUTM	SoftWeave Rectangular Tablecloth	54" x 120"	010	1 ea
53785858SM	SoftWeave Square Tablecloth	58" x 58"	010	1 ea
53787272SM	SoftWeave Square Tablecloth	72" x 72"	010	1 ea
537876RM	SoftWeave Round Tablecloth	76"	010	1 ea
537890RM	SoftWeave Round Tablecloth	90"	010	1 ea
53935252SM	SoftWeave Aspen Damask Tablecloth	52" x 52"	147	1 ea

## Classic Twill Skirting and Accessories

- Minimal fading, shrinking and wrinkling
- 100% Polyester; machine wash and dry
- Flame retardant
- Shirred skirts come complete with hook and loop tape and 550PC clips



Classic Twill Skirting w/ SoftWeave Tablecloth

### Clips

Marko offers specifically designed clips to fit a variety of table edges. From our lifetime guarantee on our metal clips to our polycarbonate plastic clips, Marko has everything you need to pull your look together.



### Classic Twill



White(010)

Black(014)

Prod No	Description	Dimensions	Color	Pack
<b>Fabric Skirting</b>				
5024CE29AF	Classic Twill Shirred Pleat Skirting w/Velcro Header & 24 Clips	13'	010, 014	1 ea
5024EG29AF	Classic Twill Shirred Pleat Skirting w/Velcro Header & 31 Clips	17.5'	010, 014	1 ea
5024FW29AF	Classic Twill Shirred Pleat Skirting w/Velcro Header & 38 Clips	21'	010, 014	1 ea
<b>Skirting Accessories</b>				
		<b>Table Edge</b>		
5CC55PC-12	Overlock & Valance Clip, Hook & Loop Header	1/2"	—	12 ea
5CC118MP-12	12 Metal Skirting Clip, Hook & Loop Header	3/8" - 1-1/4"	—	12 ea
5CC120MP-12	12 Metal Skirting Clip, Hook & Loop Header	1-1/4" - 2-1/4"	—	12 ea
5CC200PC-12	12 Plastic Skirting Clip, Hook & Loop Header	3/8" - 3/4"	—	12 ea
5CCCCLIP-12	12 Plastic Skirting Clip, Hook & Loop Header	3/4" - 2"	—	12 ea
5CCLCLIP-12	12 Large Plastic Skirting Clip, Hook & Loop Header	1-1/2" - 2-1/2"	—	12 ea

## Bistro Striped Napkins

- Popular farm-to-table look
- 100% SoftWeave fabric
- Yarn dyed stripe stays true to color without fading or bleeding
- Designed to be washed with bleach



Bistro Striped Napkins

### SoftWeave



### Bistro Striped

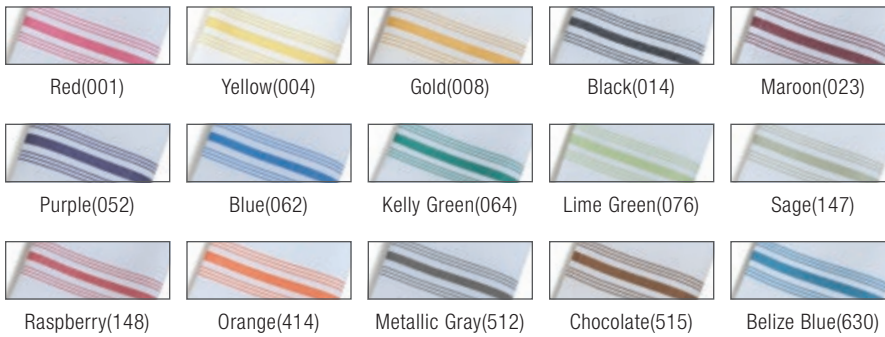

### Aspen Damask Color



Product No	Description	Finished Size	Color	Pack
<b>Fabric Napkins</b>				
53781717NM	SoftWeave Napkins	17" x 17"	010, 014, 046	12 ea
53782020NM	SoftWeave Napkins	20" x 20"	010, 014, 046	12 ea
53771822NH	SoftWeave Bistro Striped Napkin	18" x 22"	001, 004, 008, 014, 023, 052, 062, 064, 076, 147, 148, 414, 512, 515, 630	12 ea
53931717NM	Aspen Damask Napkins	17" x 17"	147	12 ea

## Vinyl Table Coverings

### Vative Series

- Premium vinyl line with the elegance and drape of fabric
- Heavy 6 gauge vinyl with polyester knit backing
- Flame retardant
- Easy care – simply wipe clean with a soft, damp cloth

### Vative Glimmer Series

- Premium vinyl line with the elegance and drape of fabric; the “shimmering” color makes it perfect for weddings or upscale gatherings.
- Heavy 6 gauge vinyl with polyester knit backing
- Flame retardant
- Easy care – simply wipe clean with a soft, damp cloth

### Classic Series

- Economical 4 gauge vinyl with polyester backing
- Flame retardant
- Easy care – simply wipe clean with a soft, damp cloth



Classic™ Series (Red Check)



Clear Vinyl

### Clear Vinyl Rolls

- Protect your tabletops and expensive fabric tablecloths from moisture and spills
- BPA free
- Flexible material withstands repeated bending and pressure
- Use for multiple meal services – reduce laundry expenses and employee labor
- Excellent choice for long- or short-term care facilities with group dining environments
- A practical choice for large-scale craft projects in schools, daycares or DIY classes



Pan Rack Cover

#### Vative Series



Stone(382)

#### Vative Glimmer

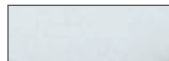

Metallic Silver(625)

#### Classic Check



Red(001)

#### Clear Vinyl Rolls



Clear(018)

#### Misc. Vinyl



Clear(018)

Product No	Description	Finished Size	Color	Pack
<b>Vinyl Tablecloths</b>				
59035252SM ♦	Vative Series	52" x 52"	382	1 ea
59085252SM ♦	Vative Series Glimmer Series	52" x 52"	625	1 ea
51515252SM ♦	Classic Series	52" x 52"	001	1 ea
<b>Clear Vinyl Rolls</b>				
53135054L	Clear Vinyl Roll, 4 Gauge, 54" Wide	50 yd	018	1 ea
53182554L	Clear Vinyl Roll, 8 Gauge, 54" Wide	25 yd	018	1 ea
53201554L	Clear Vinyl Roll, 12 Gauge, 54" Wide	15yd	018	1 ea
<b>Misc. Vinyl</b>				
5675CL ♦	Pan Rack Cover	N/A	018	1 ea

♦ California Residents: Di(2-ethylhexyl)phthalate (DEHP) **WARNING:** See appendix B on page 1

# IN-STOCK PROGRAM DETAILS

Marko In-Stock items **can be combined with any foodservice product order** to meet freight minimums. Combined product orders will **ship together** from one distribution center

## Return Policy:

- In-Stock items will offer the same 90-day return policy as foodservice
- All returns must be in original standard packs and unused, saleable condition
- See Carlisle Terms & Conditions for a complete list of requirements

## Additional Ordering Information:

- In-Stock items can be combined on one purchase order with foodservice products
- In-Stock items can be combined with made-to-measure items
- Combined orders of In-stock items and made-to-measure items will ship together upon completion of the made-to-measure items

## Note:

- Carlisle reserves the right to add or remove items from our stocking program at any time
- Made-to-measure items cannot be combined with foodservice orders

For more information, please contact your sales representative



# CALCULATING TABLECLOTH SIZE

## DROP LENGTHS

- A standard drop of 8" is recommended for all tables. That is the amount of fabric that will hang over each side of the table.
- Some operators might want a slightly shorter or longer drop. In most cases 6" is the shortest drop recommended. An 8" drop will let both fabric and vinyl tablecloths drape easily.

### Basic Table Sizing

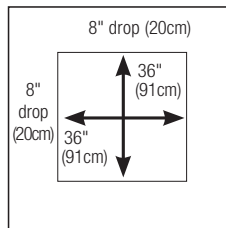

Square Or Rectangular Tables

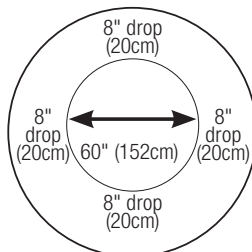

Round Tables

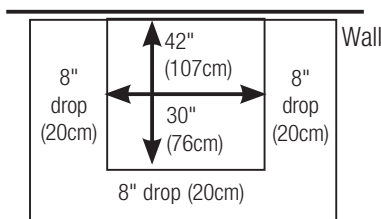

Booth Tables

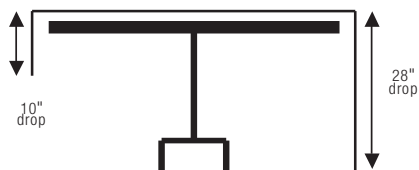

Conference Cloth

For any square, rectangular or round table, simply take the width of the tabletop, add your Drop to EACH Side and that's the size Tablecloth you need:

### EXAMPLE for a 36" Square table:

36" wide table	x	36" wide table
+16" (8" drop x's 2 sides)	x	+16" x (8" drop x's 2 sides)
52" wide cloth	x	52" wide cloth

or

### EXAMPLE for a 60" round table:

60" round table		
+16" (8" drop x 2)	x	
76" round cloth		

or

### EXAMPLE for a 30" x 42" booth table:

30" wide table	x	42" long table
+16" (8" drop x's 2 sides)	x	+ 8" (drop 1 side)
46" wide cloth	x	50" long cloth

Please specify Booth Set Up when ordering

### Conference Cloths

Conference Cloths are used to cover Conference Tables. Similar to a Head Table at a banquet, they should have an 8" or 10" drop on the open side and 28" fall, almost to the floor, on the other sides. A typical 6' Conference Table:

18" wide table	x	72" long table
+38" (10" drop + 28" drop)	x	+56" (28" drop x 2 sides)
56" wide cloth	x	128" long cloth

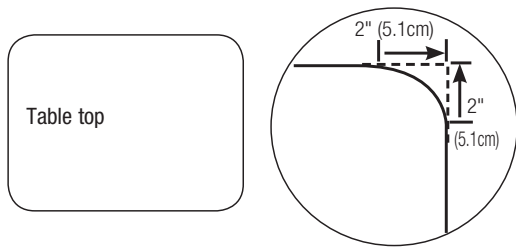
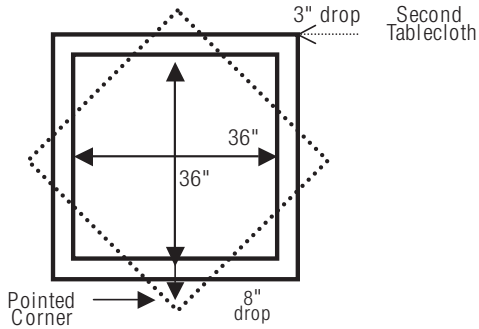
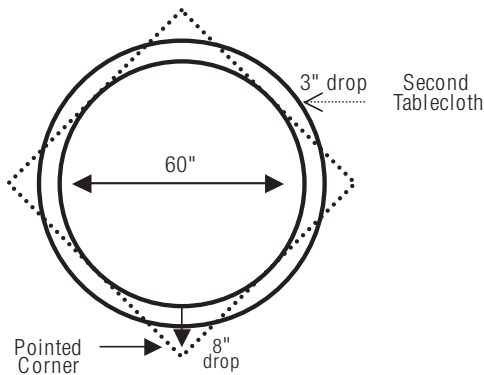

Table with radius corners



Square Or Rectangular Table OVERLAY



Round Table Overlay



## Fitted Tablecloths For Odd Shaped Corners

Marko offers Hat Box Corner form fitted tablecloths that have a continuous seam around the top edge of the table. If the corner radius of your table is greater than 2" the shape of the corner will be used. If the corner radius is less than 2" the corner will be made square. Contact your customer service representative if you have any questions regarding what type of tablecloth will work for you.

## Table Toppers

Table Toppers cover the top of Skirted Banquet Tables. They follow the same rules as any other rectangular, square, or round tablecloth. They need to be the exact length, width, or circumference of the table PLUS the desired drop length added to EVERY side. Use the formulas on page 76 and this page to calculate size.

For common applications where the Banquet Table is going to be skirted all the way around, we recommend the standard 8" drop. For Head Tables where one side of the table is going to be left open (Skirted 3-sides with returns on the corners of the 4th side), some people like a slightly longer drop of 10". You should be careful of drops over 10", as the cloth may end up resting partially in patrons' laps. A quick look at the chair seat heights in the room will help you avoid this problem.

Table Toppers are placed first with the Clips for fastening the Skirting placed over them to hold the Topper in place. For a finished look, always recommend Table Padding for Banquet Tables.

## Overlays

Overlays are placed on top of the Tablecloth on a dining table for a more formal, elegant presentation. There are two types:

- Pointed Corners: Square cloths that are set at a 45° angle on the table for the corners to hang over the side of the table
- Second Tablecloths: Exact size and shape as the table top with a 3" drop added to all sides

## Embrace

For a more tailored fit, use this guide to measure and order your specific table coverings.

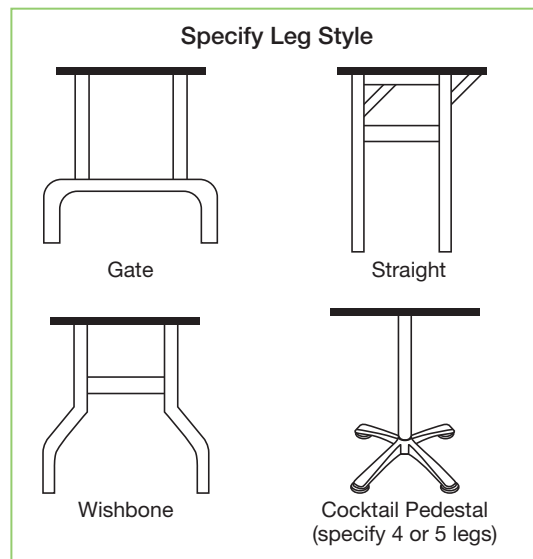



**CARLISLE**  
FOODSERVICE PRODUCTS



# STYLISH BREAK- RESISTANT CONTEMPO- RARY ELEGANT **DISPLAYWARE**

---

*How you display your culinary creations is what brings your guests in. Carlisle has everything you need to provide an organized, attractive and safe food service environment.*



# MELAMINE DISPLAYWARE

Balsam displayware is your **ideal choice** for displaying prepared food in front of your guest.



## Balsam™

- Withstands the rigors of commercial foodservice dishwasher use
- Maintains its appearance after one year of dishwasher testing
- Durable melamine is stain, scratch- and break-resistant, making it ideal for any foodservice operation
- Safe for temperatures up to 212°F
- NSF Listed; dishwasher safe



 Bavarian Cream(37)

Prod No	Description	Color	Pack
<b>Balsam Displayware</b>			
55520 $\Delta$	1" Deep Full Size Pan	37*	6 ea
55522 $\Delta$	2.5" Deep Full Size Pan	37	6 ea
55524 $\Delta$	4" Deep Full Size Pan	37	6 ea
55526 $\Delta$	1" Deep Half Long Size Pan	37	6 ea
55528 $\Delta$	2.5" Deep Half Long Size Pan	37	6 ea
55530 $\Delta$	4" Deep Half Long Size Pan	37	6 ea
55532 $\Delta$	1" Deep Half Size Pan	37*	6 ea
55534 $\Delta$	2.5" Deep Half Size Pan	37	6 ea
55536 $\Delta$	4" Deep Half Size Pan	37	6 ea
55538 $\Delta$	1" Deep Third Size Pan	37	6 ea
55540 $\Delta$	2.5" Deep Third Size Pan	37	6 ea
55542 $\Delta$	4" Deep Third Size Pan	37	6 ea
55544 $\Delta$	26 oz Angled Bowl	37	6 ea
55546 $\Delta$	3 qt Angled Bowl	37	6 ea
55550 $\Delta$	26 oz Square Bowl	37	6 ea

NSF Listed products are designated with a  $\Delta$  and may be prefixed with an N

\* Color available by special order only

Customers respond to the presentation of prepared food. **Make your presentation irresistible** with our Flared Bowls. The shape and flare **draw the eye into the food.**

### Flared Square Bowls

- Large display bowls coordinate with many other Carlisle pieces
- High quality, heavy-weight melamine
- Safe for temperatures up to 212°F
- NSF Listed; dishwasher safe



Prod No	Description	Color	Pack
<b>Flared Square Bowls</b>			
33360 $\Delta$	5 qt, 11.75" Small Flared Bowl	02, 03	4 ea
33362 $\Delta$	8 qt, 13.75" Medium Flared Bowl	02, 03	4 ea
33364 $\Delta$	15.5 qt, 16.88" Large Flared Bowl	02, 03	4 ea

NSF Listed products are designated with a  $\Delta$  and may be prefixed with an N

# MELAMINE DISPLAYWARE

The **contemporary design of Rave is the versatile choice for your displays.** Rave suits many types of cuisine and the interesting shapes create a playful display that will **draw guests to your culinary offerings.**

## Rave®

- Offers the look and feel of china without the replacement cost
- Bowls lock into pedestal for secure serving
- Skid-resistant feet
- Safe for temperatures up to 212°F
- Dishwasher safe



Prod No	Description	Color	Pack
<b>Rave Displayware</b>			
33310	7", 1.5 qt Rave Serving Bowl	02, 03	6 ea
33312	10", 4.5 qt Rave Serving Bowl	02, 03	6 ea
33314	12", 4.5 qt Rave Salad Bowl	02, 03	6 ea
33316	13", 2 qt Rave Starburst Bowl	02*, 03*	6 ea
33318	15" Rave Bowl with Rim	02*	6 ea
33320	10", 2.5 qt Rave Rectangular Platter	02	6 ea
33322	16" Rave Rectangular Platter	02, 03	6 ea
33324	23" Rave Rectangular Platter	02, 03	6 ea
33326	16" Rave Trapezoid Platter	02, 03*	6 ea
33302	4" Rave Pedestal	02*	12 ea

NSF Listed products are designated with a **▲** and may be prefixed with an N

\* Color available by special order only

The oversized scalloped platters are **perfect for display, deli and tabletop presentations.** This collection **easily coordinates with many other Carlisle pieces.**

### Scalloped Platters

- High quality, heavy-weight melamine
- Safe for temperatures up to 212°F
- NSF Listed; dishwasher safe



**Terra is a longtime Carlisle customer favorite!** The **organic design and exceptional quality** make it popular for buffet and display case use.

### Terra®

- Unique textured platters add depth
- Safe for temperatures up to 212°F
- NSF Listed; dishwasher safe



Prod No	Description	Color	Pack
<b>Scalloped Platters</b>			
7944 $\Delta$	19.5" x 13" Rectangular Small Scalloped Tray	02, 03	4 ea
7946 $\Delta$	22.5" x 14.5" Rectangular Medium Scalloped Tray	02, 03	4 ea
7948 $\Delta$	24.5" x 18.5" Rectangular Large Scalloped Tray	02, 03	4 ea
<b>Terra Displayware</b>			
44514 $\Delta$	14" Round Textured Platter	02	12 ea
44518 $\Delta$	18" Round Textured Platter	02, 03	12 ea
44520 $\Delta$	13.5" x 9.25" Rectangular Textured Platter	03	4 ea
44522 $\Delta$	15.5" x 11" Rectangular Textured Platter	02, 03	4 ea
44524 $\Delta$	18" x 12.5" Rectangular Textured Platter	02	4 ea

NSF Listed products are designated with a  $\Delta$  and may be prefixed with an N

# MELAMINE DISPLAYWARE

The Palette Designer series is **perfect for large food presentations.** We offer a **wide rim style that frames your food beautifully.**

## Palette Designer Displayware®

- Combine with decorated Palette pieces for attention getting displays in the deli case or buffet line
- Break-resistant construction reduces replacement costs
- High quality, heavy-weight melamine
- Safe for temperatures up to 212°F
- NSF Listed; dishwasher safe

### Wide Rim

- Use with displayware covers shown on the facing page



Prod No	Description	Cover	Color	Pack
<b>Palette Designer Displayware</b>				
43024 Δ	12" Wide Rim Round Plate	1994*	02	12 ea
44400 Δ	12" Wide Rim Square Plate	44400C	02, 03	4 ea
44402 Δ	14", 4.5 qt Wide Rim Square Bowl	44402C	02, 03	4 ea
44404 Δ	15" Wide Rim Round Platter	44404C	02	4 ea
44406 Δ	19" Wide Rim Round Platter	—	02, 03	4 ea
44410 Δ	17" X 13" Wide Rim Oval Platter	44410C	02, 03	4 ea
44412 Δ	21" X 15" Wide Rim Oval Platter	44412C	02, 03	4 ea
44414 Δ	14" X 10" Wide Rim Rectangle Platter	44414C	02, 03	4 ea
44416 Δ	17" X 13" Wide Rim Rectangle Platter	—	02, 03	4 ea
44418 Δ	22" Wide Rim Salmon Platter	—	02, 03	4 ea

NSF Listed products are designated with a Δ and may be prefixed with an N

\*1994 Plate Cover can be found in the Dinnerware section of this catalog

### Food Pans

- 2.5" and 4" deep pans can be turned over and used as display stands
- Combine with display covers shown below to create an attractive merchandising display
- NSF Listed; dishwasher safe



### Palette Displayware Covers

- Designed to work with selected pieces of our Palette Displayware
- Clear polycarbonate covers are highly heat- and break-resistant
- Allows you to safely protect and transport dishes prepped in advance
- Stack for compact storage
- Dishwasher safe



Prod No	Description	Cover	Color	Pack
<b>Palette Designer Displayware Food Pans</b>				
44420 $\Delta$	1" D Full Size Food Pan, 20.75" x 12.75"	—	02, 03	6 ea
44422 $\Delta$	2.5" D Full Size Food Pan, 20.75" x 12.75"	—	02, 03	6 ea
44430 $\Delta$	1" D Half Size Food Pan, 12.75" x 10.38"	44432C	02	6 ea
44432 $\Delta$	2.5" D Half Size Food Pan, 12.75" x 10.38"	44432C	02	6 ea
44460 $\Delta$	1" D Third Size Food Pan, 12.75" x 6.87"	—	02, 03	6 ea
44462 $\Delta$	2.5" D Third Size Food Pan, 12.75" x 6.87"	—	02	6 ea
<b>Palette Designer Displayware Covers</b>				
44410C $\diamond$	Cover for 17" x 13" Wide Rim Oval Platter	—	07	12 ea
44414C $\diamond$	Cover for 14" x 10" Wide Rim Rectangle Platter	—	07	12 ea
44432C $\diamond$	Cover for Half Size Food Pan	—	07	12 ea

NSF Listed products are designated with a  $\Delta$  and may be prefixed with an N  
 $\diamond$  California Residents: Bisphenol A **WARNING:** See appendix A on page 1

# MELAMINE DISPLAYWARE

These 6 versatile pieces **coordinate beautifully with our Epicure Dinnerware** pieces that are offered **on page 27**

## Epicure® Displayware

- Stain- and scratch-resistant finish
- Made of dependable, impact-resistant melamine
- Safe for temperatures up to 212°F
- NSF Listed; dishwasher safe



Narrow rimmed platters **provide a larger landscape for your food presentations**. Carlisle offers **5 shapes and sizes** to give you the perfect size for your application.

## Narrow Rimmed Displayware

- Rimmed style displayware in a variety of shapes
- Stain- and scratch-resistant finish
- Made of dependable, impact-resistant melamine
- Safe for temperatures up to 212°F
- NSF Listed; dishwasher safe



Prod No	Description	Color	Pack
<b>Epicure Displayware</b>			
ARR240 <span style="color: teal;">▲</span>	46 oz, 9" Round Open Vegetable Bowl	02	12 ea
5933 <span style="color: teal;">▲</span>	32 oz, 8.25" Round Bowl	02	24 ea
43737 <span style="color: teal;">▲</span>	24 oz, 7.38" Footed Serving Bowl	02, 03	12 ea
43738 <span style="color: teal;">▲</span>	36 oz, 8.63" Footed Serving Bowl	02	12 ea
43739 <span style="color: teal;">▲</span>	57 oz, 9.25" Footed Serving Bowl	02	12 ea
43842 <span style="color: teal;">▲</span>	14" x 10" Oblong Platter	02, 03	12 ea
<b>Narrow Rimmed Displayware</b>			
ARR112 <span style="color: teal;">▲</span>	14.75" x 10.5" Oval Platter	02	12 ea
ARR120 <span style="color: teal;">▲</span>	12" x 8.5" Oval Platter	02, 25	12 ea
43745 <span style="color: teal;">▲</span>	28 oz, 10" x 7.5" Baker/Server	02, 25	12 ea
43840 <span style="color: teal;">▲</span>	21" x 15" Catering Platter	02, 03	6 ea
43772 <span style="color: teal;">▲</span>	15.5" x 10.5" Oblong Platter	02	12 ea

NSF Listed products are designated with a ▲ and may be prefixed with an N



## Salad Bowl

- Made of dependable, impact-resistant melamine
- Safe for temperatures up to 212°F
- NSF Listed; dishwasher safe



1000B

## Scalloped DeliWare® & Inset

- Low profile reduces food waste without sacrificing presentation
- 5.5" Square Scalloped Dish is designed to use alone or as an inset in the 18" x 7" Scalloped Platter (7932)
- Use the combination of our inset and platter for displaying foods with toppings or sauces
- Durable melamine material
- NSF Listed; dishwasher safe



7930

7934

7932

Black(03)

Prod No	Description	Color	Pack
<b>Melamine Salad Bowls</b>			
1000B $\Delta$	1.9 qt, 10" Bowl	03	6 ea
<b>Scalloped DeliWare &amp; Inset</b>			
7930 $\Delta$	14" x 10" Scalloped Baker	03	4 ea
7932 $\Delta$	18" x 7" Scalloped Platter	03	4 ea
7934 $\Delta$	5.5" Square Scalloped Dish/Inset	03*	48 ea

NSF Listed products are designated with a  $\Delta$  and may be prefixed with an N

\* Color available by special order only



# DISPLAYWARE

The look of Acacia Wood **without the hassle**. The Epicure Acacia Wood Grain line features an **assortment of sizes and shapes** and offers something for every type of food and venue.

## Epicure® Acacia Wood Grain

- Durable Material is made of sturdy, break resistant melamine
- Look of organic acacia wood without the inconvenient need to handwash or season
- Buyer's assurance with a limited warranty against breakage
- Large selection with a size to fit every serving need from Dip Bowls to 18" Round platters
- Safe for temperatures up to 212°F
- Dishwasher safe and stain resistant
- NSF Listed



EAG09 Flight Tray & EAG08 Dip Bowls



Prod No	Description	Color	Pack
<b>Epicure Acacia Wood Grain Displayware</b>			
EAG01 $\Delta$	7.5", 34 oz Small Bowl	69	12 ea
EAG02 $\Delta$	12", 4.8 qt Serving Bowl	69	6 ea
EAG04 $\Delta$	18" x 15" Oval Platter	69	6 ea
EAG05 $\Delta$	13.88" x 7.75" Rectangular Tray	69	12 ea
EAG06 $\Delta$	18" Round Platter	69	6 ea
EAG07 $\Delta$	14.75" x 6.75" Rectangular Tray	69	12 ea
EAG08 $\Delta$	4.38", 5 oz Dip Bowl	69	12 ea
EAG09 $\Delta$	13.19" Flight Tray	69	6 ea
EAG10 $\Delta$	19.25" Round Platter	69	2 ea
EAG11 $\Delta$	9" Square Tray	69	12 ea

NSF Listed products are designated with a  $\Delta$  and may be prefixed with an N

## Designer Displayware®

- Heavy, china/ceramic feel and look without the breakage
- Perfect for salads and entrées in family style dining, banquets, buffets or deli display cases
- Select pieces available in unique two-tone Mosaic colors
- FDA approved material
- Safe for temperatures up to 212°F
- NSF Listed; dishwasher safe



Prod No	Description	Color	Pack
<b>Designer Displayware</b>			
7910 $\Delta$	5 lb, 10.5" Designer Pasta Bowl	02, 03	4 ea
7913 $\Delta$	10 lb, 13" Designer Pasta Bowl	02, 03	4 ea
7914 $\Delta$	2 qt, 14" x 10" Oval Designer Platter	02, 03	4 ea
7916 $\Delta$	3 qt, 16" x 12" Oval Designer Platter	02, 03	4 ea
7918 $\Delta$	4 qt, 19" x 13.75" Oval Designer Platter	02, 03	4 ea
7919 $\Delta$	2.9 qt, 9" x 12" Designer Baker	02, 03	4 ea
7920 $\Delta$	4 qt, 10" x 14" Designer Baker	02, 03	4 ea
<b>Mosaic Designer Displayware</b>			
8919 $\Delta$	2.9 qt, 9" x 12" Mosaic Baker	406*	4 ea
8920 $\Delta$	4 qt, 10" x 14" Mosaic Baker	406	4 ea

NSF Listed products are designated with a  $\Delta$  and may be prefixed with an N

\* Color available by special order only

# DISPLAYWARE

## Tulip Deli® Crocks

- Beautiful swirl pattern and high gloss finish
- Crocks nest for easy storage
- Durable SAN plastic is resistant to food oils and acids
- Safe for use in temperatures from 0° to 180°F
- Dishwasher safe



## Scoop Bowl

- 4 qt bowls are perfect for buffets or salad bar
- Durable SAN plastic is resistant to food oils and acids
- For use in temperatures from 0° to 180°F
- Dishwasher safe



Prod No	Description	Color	Pack
<b>Tulip Deli Crocks</b>			
6963 ♦	5 lb, 10.38" x 6.75" Tulip Deli Crock	02, 03, 05	6 ea
6966 ♦	10 lb, 13" x 10.38" Tulip Deli Crock	02, 03, 05	6 ea
<b>Scoop Bowl</b>			
0411	4 qt, 13.75" x 9.38" Scoop Bowl	02, 03	4 ea

NSF Listed products are designated with a **▲** and may be prefixed with an N  
 ♦ California Residents: Bisphenol A **WARNING:** See appendix A on page 1

## Orchid® Deli Bowls

- Polycarbonate bowls and crocks have a beautiful, glass-like appearance without the breakage
- Extremely break-resistant material can be used in heated cases or on hot tiles up to 212°F
- Withstands exposure to food acids
- NSF Listed; dishwasher safe



Black(03)

Prod No	Description	Color	Pack
<b>Orchid Deli Bowls</b>			
6531 $\Delta$ ♦	1.5 qt, 8" Orchid Deli Bowl	03	12 ea
6532 $\Delta$ ♦	3 qt, 10" Orchid Deli Bowl	03	12 ea
6534 $\Delta$ ♦	7 qt, 12" Orchid Deli Bowl	03	12 ea

NSF Listed products are designated with a  $\Delta$  and may be prefixed with an N  
 ♦ California Residents: Bisphenol A **WARNING:** See appendix A on page 1



# DISPLAYWARE

## Octagon Bowls

- Contemporary octagonal shape is ideal for table service, buffets, salad bars or deli displays
- Made of glossy acrylic
- 8888 offers the increased durability of SAN and is safe for use in temperatures from 32° to 160°F
- Dishwasher safe



## Octagonal Cocks

- Crock inserts eliminate waste while giving a full appearance
- 2.5 lb low profile crock (6723) can be used as an insert for the 5 lb crock
- 5 lb low profile crock (6726) can be used as an insert for the 10 lb crock
- Durable SAN plastic is resistant to food oils and acids
- Safe for use in temperatures from 0° to 180°F
- Dishwasher safe



Prod No	Description	Color	Pack
<b>Octagon Bowls</b>			
8886	2.5 lb, 7.13" x 2.87" Octagon Bowl	03	4 ea
8887	5 lb, 9.19" x 3.04" Octagon Bowl	03	4 ea
8888	8 lb, 9.38" x 4.1" Deep Octagon Bowl	03	4 ea
<b>Octagonal Cocks</b>			
6713	5 lb, 10.63" x 7.19" Octagonal Crock	03	6 ea
6723	2.5 lb Low Profile Octagonal Crock (and Insert for 5 lb Crock 6713)	02, 03	6 ea
6716	10 lb, 13.31" x 10.5" Octagonal Crock	03	6 ea
6726	5 lb Low Profile Octagonal Crock (and Insert for 10 lb Crock 6716)	03	6 ea

**Make waves with our modular displayware!** This modular display system gives you so many options in setting up your display and it all looks perfectly organized when you are done.

### Modular Displayware

- Wave shape offers visual interest while enhancing the display
- Unique, flexible displayware provides an attractive solution for merchandising prepared food
- Fits in standard size food wells
- Half long lid can be used as a display tray for sliced deli meats and cheeses
- Made of tough, break-resistant polycarbonate
- Safe for use in temperatures ranging from -40° to 212°F
- NSF Listed; dishwasher safe



Collar provides support for smaller pans when used in a food well



Prod No	Description	Color	Pack
<b>Modular Displayware</b>			
6982 $\Delta$ $\blacklozenge$	4.45 qt Half Long Pan - Wavy Edge	03, 07*	6 ea
6990 $\Delta$ $\blacklozenge$	4.45 qt Half Long Pan - Straight Edge	03	6 ea
6982L $\Delta$ $\blacklozenge$	Half Long Lid	07	6 ea
6988 $\Delta$ $\blacklozenge$	Half Long Collar	03	6 ea
6984 $\Delta$ $\blacklozenge$	6.5 cup, 2.5" Deep Half Size Pan	03	6 ea
69844 $\Delta$ $\blacklozenge$	9.25 cup, 4" Deep Half Size Pan	03	6 ea
69846 $\Delta$ $\blacklozenge$	13 cup, 6" Deep Half Size Pan	03	6 ea
6984L $\Delta$ $\blacklozenge$	Half Size Lid	07	6 ea
6986 $\Delta$ $\blacklozenge$	4 cup, 2.5" Deep Third Size Pan	03	6 ea
69864 $\Delta$ $\blacklozenge$	5.6 cup, 4" Deep Third Size Pan	03	6 ea
69866 $\Delta$ $\blacklozenge$	7.8 cup, 6" Deep Third Size Pan	03	6 ea

NSF Listed products are designated with a  $\Delta$  and may be prefixed with an N

\* Color available by special order only

$\blacklozenge$  California Residents: Bisphenol A **WARNING:** See appendix A on page 1

# DISPLAYWARE

## Rectangular Deli Crock

- Rectangular deli crock saves space in display cases
- Acrylic crock has a high gloss finish
- Safe for use in temperatures from 32° to 160°F
- Dishwasher safe



8821

## Deliware® Rectangular Crocks

- Economical durable polypropylene for maximum impact resistance in cold temperatures
- Safe for use in temperatures from 32° to 170°F



8112

8110



Prod No	Description	Color	Pack
<b>Rectangular Deli Crock</b>			
8821	10 lb, 12" x 10" Rectangular Crock	03*	4 ea
<b>Deliware Rectangular Crocks</b>			
8110	5 lb, 10" x 6" Rectangular Crock	02, 03	12 ea
8112	10 lb, 12.5" x 10.25" Rectangular Crock	02, 03	6 ea

\* Color available by special order only



## Petal Mist® Plates, Bowls & Trays

- Petal Mist's delicate design gives an elegant appearance; perfect for buffets, food bars, delis, poolside and catering
- Textured exterior hides scratches; easy-clean smooth interior
- Made of tough, break-resistant polycarbonate
- Safe for use in freezers and in temperatures from 40° to 212°F
- Coordinates with Petal Mist Dinnerware—See page 29
- NSF Listed; dishwasher safe



Prod No	Description	Color	Pack
<b>Petal Mist Plates, Bowls &amp; Tray</b>			
6908 ▲◆	1.2 qt, 7.5" Petal Mist Bowl	03, 07	36 ea
6909 ▲◆	2.4 qt, 9" Petal Mist Bowl	03, 07	12 ea
6931 ▲◆	3.4 qt, 9.75" Petal Mist Bell Bowl fits 8.25" template opening	03, 07	4 ea
6914 ▲◆	5.6 qt, 12" Petal Mist Bowl	03, 07	4 ea
6917 ▲◆	9.7 qt, 15" Petal Mist Bowl	03, 07	4 ea
6919 ▲◆	17.2 qt, 18" Petal Mist Bowl	03, 07	4 ea
6942 ▲◆	13" Petal Mist Plate	07	6 ea
6947 ▲◆	16" x 22" Petal Mist Rectangular Tray	07	6 ea

NSF Listed products are designated with a ▲ and may be prefixed with an N  
 ◆ California Residents: Bisphenol A **WARNING:** See appendix A on page 1



# DISPLAYWARE

## Bell Bowls

- Pebbled design made of crystal-clear acrylic
- Dishwasher safe



## Stack Bowls

- Use for food bars, buffets or table service
- 15" deep rim gives a stylish bowl appearance when placed into ice or refrigerated food bar templates
- Acrylic is resistant to food acids and oils
- Dishwasher safe



## Leaf Bowls

- Perfect for salad bar or table service
- Acrylic is resistant to food acids and oils
- For use in temperatures from 32° to 160°F
- Dishwasher safe



## Buffet Clam Shells

- Perfect for presenting seafood, salads and appetizers in a buffet or salad bar
- Durable SAN plastic is resistant to food oils and acids
- Safe for use in temperatures from 0° to 180°F
- Dishwasher safe



Prod No	Description	Color	Pack
<b>Bell Bowls</b>			
SB90	3.3 qt, 11" Acrylic Pebbled Bowl	07	4 ea
SB94	6 qt, 14" Acrylic Pebbled Bowl	07	4 ea
<b>Stack Bowls</b>			
8038	1.5 qt, 8" x 3.5" Stack Bowl	03	4 ea
8099	2.5 qt, 9" x 3.5" Stack Bowl	03	4 ea
8100	3 qt, 9.5" x 4" Stack Bowl	03	4 ea
<b>Leaf Bowls</b>			
LB12	3 qt, 11.25" Leaf Bowl	07	4 ea
LB16	8 qt, 15.38" Leaf Bowl	07	4 ea
<b>Buffet Clam Shells</b>			
339	12 oz, 8.88" x 5.5" Small Clam Shell	02, 07	12 ea
0340	22 oz, 11" x 7" Medium Clam Shell	02, 03, 07	12 ea
0344 Δ	5 qt, 19" x 12.88" Large Clam Shell	02, 03, 07	1 ea

NSF Listed products are designated with a Δ and may be prefixed with an N

## Round Polycarbonate Pebbled Bowls

- Pebbled exterior resists scratches
- Smooth interior is unaffected by salad oils, food acids or dressings
- Durable polycarbonate is safe for use in temperatures from 40° to 212°F
- NSF Listed; dishwasher safe



## Acrylic Pebbled Bowls

- Acrylic bowls have heat polished, high-gloss rim
- Pebbled finish resists scratches
- Dishwasher safe



**Prod No**      **Description**      **Color**      **Pack**

### Round Polycarbonate Pebbled Bowls

7206 $\Delta$ ♦	0.6 qt, 6" Round PC Bowl	07	12 ea
7208 $\Delta$ ♦	1.62 qt, 8" Round PC Bowl	07	12 ea
7210 $\Delta$ ♦	3 qt, 10" Round PC Bowl	07	12 ea
7212 $\Delta$ ♦	5.5 qt, 12" Round PC Bowl	07	12 ea
7215 $\Delta$ ♦	11 qt, 15" Round PC Bowl	07	4 ea
7218 $\Delta$ ♦	18 qt, 18" Round PC Bowl	07	4 ea
7223 $\Delta$ ♦	33 qt, 23" Round PC Bowl	07	4 ea

### Round Acrylic Pebbled Bowls

SB66	.5 qt, 6" Acrylic Round Bowl	07	8 ea
SB68	1 qt, 8" Acrylic Round Bowl	07	4 ea
SB70	2 qt, 10" Acrylic Round Bowl	07	4 ea
SB72	4 qt, 12" Acrylic Round Bowl	07	4 ea
SB74	7 qt, 14" Acrylic Round Bowl	07	4 ea
SB76	10 qt, 16" Acrylic Round Bowl	07	4 ea
SB78	15 qt, 18" Acrylic Round Bowl	07	4 ea
SB79	24 qt, 22" Acrylic Round Bowl	07	4 ea

### Oval Acrylic Pebbled Bowls

OSB172	5.5 qt, 10.5" x 14" Acrylic Oval Bowl	07	4 ea
OSB176	11 qt, 13" x 18" Acrylic Oval Bowl	03, 07	4 ea
OSB178	15 qt, 15.25" x 21.88" Acrylic Oval Bowl	03, 07	4 ea

NSF Listed products are designated with a  $\Delta$  and may be prefixed with an N  
 Shipping Notes: 7223 and SB79 can ship UPS/FedEx Ground at oversize cost

♦ California Residents: Bisphenol A **WARNING:** See appendix A on page 1

# DISPLAYWARE

## Double-Wall Stainless Steel Displayware

- Beautiful, heavy-duty, stainless steel displayware designed for delis, buffets and special event service
- The modern hammered finish hides scratches for a longer life
- Double wall construction provides insulation to help with temperature retention with both hot and cold foods; no need to preheat or chill
- Double wall construction with air insulation prevents sweating for a fresher looking display
- 609201, 609202, 609203 and 609204 bowls have dual-base indentions allowing bowls to sit flat or at an angle for a more dramatic display and easy food access
- Keeps food under 41°F for up to 2 hours or more



### Double Wall Construction/Air Insulation:

- Helps with temperature retention for both hot and cold foods
- Keeps food under 41°F for up to 2 hours or more

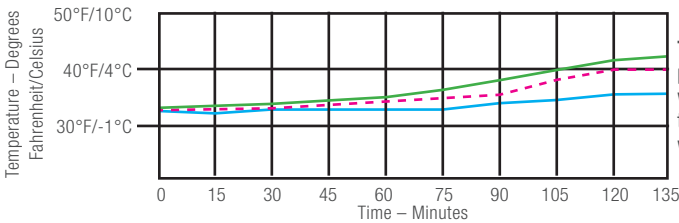

- 609211 3.5 qt, 10" Square Bowl
- 609209 4.38 qt, 10-3/4" Serving Bowl
- 609204 9.5 qt, 14" Dual Angle Bowl

**Testing Conditions:** Chilled cottage cheese was placed in a room temperature bowl. The bowls were left undisturbed in a 72° to 78°F room until temperatures rose above 40°F. Temperature in center was measured and recorded in 5 minute increments.

Prod No	Description	Pack
<b>Double-Wall Stainless Steel Displayware</b>		
609201	1.7 qt, 8" Dual Angle Bowl with Hammered Finish	2 ea
609202	3.38 qt, 10" Dual Angle Bowl with Hammered Finish	2 ea
609203	5.75 qt, 12" Dual Angle Bowl with Hammered Finish	2 ea
609204	9.5 qt, 14" Dual Angle Bowl with Hammered Finish	2 ea
609209	4.38 qt, 10.75" Serving Bowl with Hammered Finish	2 ea
609211	3.5 qt, 10" Square Bowl with Hammered Finish	2 ea
609216	15" x 8.5" Curved Tray with Hammered Finish	2 ea

## Display Covers (Cover Only)

- Covers enhance and protect the look of your food items; helps keep food fresh
- Use for merchandising fresh fruits, desserts, salads, sandwiches or bakery items
- Polycarbonate dome covers add increased durability and can be used in more extreme foodservice applications



PSD21EH

Use Display Covers with our full- and half-size food pans shown on pages 224-225

## Cake Covers & Tray

- Clear covers display desserts and pastries
- Sanitary covers help keep foods fresher longer
- Dishwasher safe



2512

3004

SC32

## Step Risers

- Step Risers create height in your food presentation
- Offers better visibility and helps merchandise foods

### Polycarbonate Step Risers

- 6843 polycarbonate riser is virtually unbreakable; won't dent or chip

### ABS Step Risers

- Edges have air slots for increased air circulation
- ABS plastic is very durable and easy to clean; will not warp or chip
- Textured satin finish decreases glare, hides scratches



6863

6843



Prod No	Description	Pack
<b>Display Covers (Trays Not Included)</b>		
PSD13EH ♦	12" x 10" End Cut Display Cover	1 ea
PSD13CH ♦	12" x 10" Center Cut Display Cover	1 ea
PSD21EH ♦	12" x 20" End Cut Display Cover	1 ea
PSD21CH ♦	12" x 20" Center Cut Display Cover (7.88" x 6.75" opening)	1 ea
PSD21DEH ♦	12" x 20" Double End Cut Display Cover	1 ea
<b>Cake Covers &amp; Tray</b>		
SC32	12" x 6" Cake Cover, Acrylic	6 ea
2512	12" x 6.5" Cake Cover, SAN	6 ea
3004	14" Display Tray, SAN	12 ea
<b>Step Risers</b>		
6843 ▲ ♦	11.75" 3-Step Polycarbonate Riser**	1 ea
6863	23.5" 3-Step Riser ABS Riser	1 ea

NSF Listed products are designated with a ▲ and may be prefixed with an N

\*\*Item available by special order only

♦ California Residents: Bisphenol A **WARNING:** See appendix A on page 1



# SERVINGWARE

The rustic charm of this **hammered steel inspired** serveware adds an **upscale flare to foodservice displays** with the unbeatable **durability of stainless steel.**

## Terra™ Stainless Steel Serveware

- Contemporary finish of hammered steel styling creates a rustic, urban-luxury aesthetic
- Versatile and subtle styling complements existing serveware ideal for restaurants, delis and buffets
- Durable metal is forged from 18/0, 430 grade stainless steel for a superior lifespan
- Weight balanced design allows for easy holding/gripping
- Dishwasher safe
- Towel dry recommended



Prod No	Description	Pack
<b>Terra Stainless Steel Serveware</b>		
60200	12" Solid Serving Spoon	12 ea
60201	12" Slotted Serving Spoon	12 ea
60202	12" Cold Meat Fork	12 ea
60203	13.5" Ladle	12 ea
60204	12" Pie Server	12 ea
60205	10" Solid Spoon	12 ea
60206	9.5" Solid Spoon	12 ea
60207	11" Cake Server	12 ea
60208	8.75" Ladle	12 ea
60209	7" Tong	12 ea
60210	10" Tong	12 ea
60211	12" Tong	12 ea

## Aria™

- Beautiful gleaming 18-8 mirror polished stainless steel
- Heavy-duty and more economical than comparable hollow handle items
- Ladles have one ounce oval shaped bowl for pouring dressings from either side
- Dishwasher safe



Prod No	Description	Pack
<b>Aria</b>		
609001	12" Aria Solid Spoon	12 ea
609002	12" Aria Slotted Spoon	12 ea
609005	10.75" Aria Cold Meat Fork	12 ea
609006	11.75" Aria Wide Pie Server	12 ea
609007	11" Aria Narrow Pastry Server	12 ea
609009	10" Aria Solid Spoon	12 ea
600295	9.5" Aria Ladle	12 ea
600296	13.5" Aria Ladle	12 ea
604460	9.25" Aria Solid Spoon	12 ea
604606	6" Aria Salad Tong	12 ea
604609	9" Aria Salad Tong	12 ea



# SERVINGWARE

## Buffet Tongs

- Heavy-duty 18-8 stainless steel with mirror polished finish for long lasting use
- Durable sanitary one-piece construction
- Scissor tongs are two-piece satin finish construction
- Dishwasher safe



Prod No	Description	Pack
<b>Buffet Tongs</b>		
607680	8" Pastry Tong	12 ea
607682	8" Serving Tong	12 ea
607683	10.25" Scalloped Serving Tong	12 ea
607685	10" Scissors Salad Tong	12 ea
607687	9.25" Bread Serving Tong	12 ea
607690	5.75" Ice Tong	12 ea
607691	7" Ice Tong	12 ea
607692	10" Scalloped Bread Serving Tong	12 ea
607693	9" Salad Tong	12 ea
607695	9.5" Pastry Tong	12 ea
607697	11.75" Serving Tong	12 ea



# ICE SCULPTURES

## Ice Sculptures

- Quick and easy way to turn any table into a showpiece
- Fill mold with water, freeze (48-72 hours) and cut open the mold
- Features patented EZ-Cut Bead™ and Contracting Cone Base™
- One time use
- Instructions included with every Ice Sculpture



SCL1

SSW1



SD01

SBG1

Contracting Cone Base allows for expansion while freezing to eliminate the major cause of cracking and breaking in the freezing process.

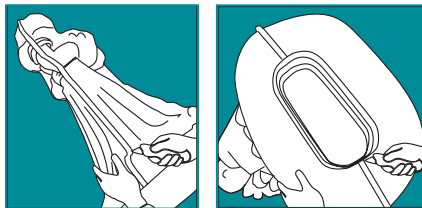

SEA1

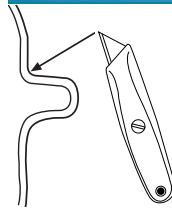

Exclusive EZ-Cut Bead opening system makes it quick and easy to un-mold a work of art.



SD01

## Illuminated Trays

- Perfect for use at buffets or banquets or as an accent for ice sculptures
- Light boxes come with Blue, Red and Yellow colored panels
- Light box is UL listed, fuse protected and operates on 115 volt/60 cycle AC
- Drain kits included

White(02)	Designated(00)
-----------	----------------

Prod No	Description	Color	Pack
<b>Ice Sculptures</b>			
SSW1	Swan: 19" L x 12" W x 21.5" H	02	1 ea
SD01	Dolphin: 20.5" L x 14.25" W x 25" H	02	1 ea
SBG1	Bride and Groom: 22" L x 14" W x 28" H	02	1 ea
SCL1	Clam Shell: 18" L x 12" W x 19" H	02	1 ea
SEA1	Eagle: 15.5" L x 24" W x 29" H	02	1 ea
<b>Illuminated Trays</b>			
SL6011L	Large Light Box (no tray)	00	
SL6011TC*	Large Smooth Light Box Tray (only)	00	1 ea

\* Drain Kits are included with Light Box Tray

NOTE: Light Boxes & Trays are sold separately; SD01, SBG1, SCL1 and SEA1, can be shipped UPS/FedEx Ground at oversize cost



# BUFFET ACCESSORIES

## NeWave™ Drip Trays

- Patented NeWave Drip Trays with open, free-flowing design dissipates fluid spills evenly to allow quicker evaporation
- NeWave pattern keeps mug, cup and pitcher bases dryer by eliminating the common fluid traps on other designs
- Easy to empty and clean
- NSF Listed; dishwasher safe

Octagonal Drip Tray U.S. Patent No. D-418,376;  
 Rectangular Drip Tray U.S. Patent No. D-418,377



## Punch/Serving Bowls

- Mirror-polished finish exterior and rim, satin finish interior
- Heavy gauge 18-8 stainless steel with argon welded bases for exceptional strength
- Handwashing recommended



Black(03)

Prod No	Description	Color	Pack
<b>NeWave Drip Trays</b>			
11020 $\Delta$	NeWave 4" Square Drip Tray	03	12 ea
11030 $\Delta$	NeWave 4" Octagon Drip Tray	03	12 ea
11026 $\Delta$	NeWave 6" Square Drip Tray	03	12 ea
11036 $\Delta$	NeWave 6" Octagon Drip Tray	03	12 ea
<b>Punch/Serving Bowls</b>			
609310	10 qt, 15.5" Punch/Serving Bowl	—	1 ea
609316	16 qt, 18" Punch/Serving Bowl	—	1 ea

NSF Listed products are designated with a  $\Delta$  and may be prefixed with an N

## MirAcryl™ Cubes

- Design allows smaller size cubes to nest inside larger cubes for convenient storage
- Invert to use as ice bucket or wine server
- Light-weight, break-resistant acrylic



## MirAcryl Mirrored Display Trays

- Beautiful, durable display pieces are easy to clean
- Made of light-weight acrylic
- Two-sided surface – use Mirrored or solid Black side for display

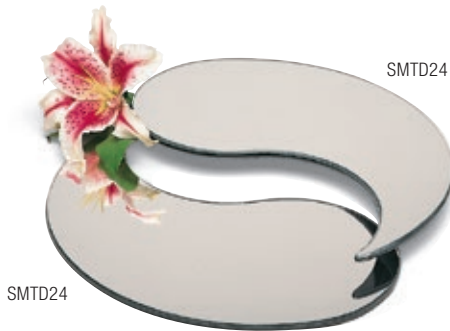

Mirror Acrylic(23)

Prod No	Description	Color	Pack
<b>MirAcryl Cubes</b>			
SMMC10	10" Mirror Cube	23	1 ea
SMMC12	12" Mirror Cube	23	1 ea
<b>MirAcryl Mirrored Display Trays</b>			
SMO1624	24" x 16" Oval MirAcryl Tray	23	1 ea
SMR1624	24" x 16" Rectangle MirAcryl Tray	23	1 ea
SMR1836	36" x 18" Rectangle MirAcryl Tray	23	1 ea
SMR24	24" Round MirAcryl Tray	23	1 ea
SMTD24	24" Teardrop MirAcryl Tray	23	1 ea

NOTE: MirAcryl™ is not returnable if the protective film is removed



**CARLISLE**  
FOODSERVICE PRODUCTS



# INNOVATIVE GUEST- PLEASING VERSATILE DEPENDABLE **FOOD BARS & CONVENIENCE PRODUCTS**

---

*Carlisle's workhorse portable food bars, innovative Coldmaster line and industry-leading lineup of serving and convenience smallwares are critical dining supplies for your operation.*

*Count on Carlisle to offer products that are attractive, durable and designed to improve your operational efficiency.*





# COLDMASTER®

The Coldmaster solution **eliminates** the **inconvenience** and mess of ice, as well as reduces the potential for bacteria. The Coldmaster solution is **revolutionizing** the food pan category, offering **innovative** solutions and **making work easier**.



## Coldmaster® CoolCheck™

- Patent-pending technology allows you to quickly see when temperatures are no longer safe
- Same great features as our standard Coldmaster products with the added element of color-changing technology
- Eliminates the guessing game behind food safety
- Unit holds food safely below 41°F for 6-8 hours\*
- Reduces waste by “telling” workers when food temperature is safe
- Eliminates the mess and inconvenience of ice
- FDA approved; dishwasher safe
- Use Coldmaster Lids listed on pages 111-112
- NSF Listed

\*Time will vary based on ambient room temperature



Designed to fit in standard sized food pan templates or food wells



Food Safe Temp

Above Food Safe Temp

White(02)

Prod No	Description	Color	Pack
<b>Coldmaster CoolCheck</b>			
CM1100C14 <b>Δ</b>	6" Deep Full-size Food Pan	02	1 ea
CM1101C14 <b>Δ</b>	6" Deep Half-size Food Pan	02	1 ea
CM1102C14 <b>Δ</b>	6" Deep Third-size Food Pan	02	1 ea
CM1103C14 <b>Δ</b>	6" Deep Third-size Divided Food Pan	02	1 ea
CM1104C14 <b>Δ</b>	6" Deep Sixth-size Food Pan	02	1 ea
CM1105C14 <b>Δ</b>	6" Deep High Capacity Sixth-size Food Pan	02	1 ea

NSF Listed products are designated with a **Δ** and may be prefixed with an N



### The Coldmaster Solution:



- High-impact ABS plastic holds up to foodservice use
- Exclusive refrigerant gel ensures high performance  
Non-toxic gel receives a cold "charge" when frozen overnight, which enables it to keep your food cold throughout the day
- Extra insulation surrounds refrigerant gel for maximum cold retention
- Refrigerant gel is enclosed in a bag; prevents leaks, even if shell is damaged

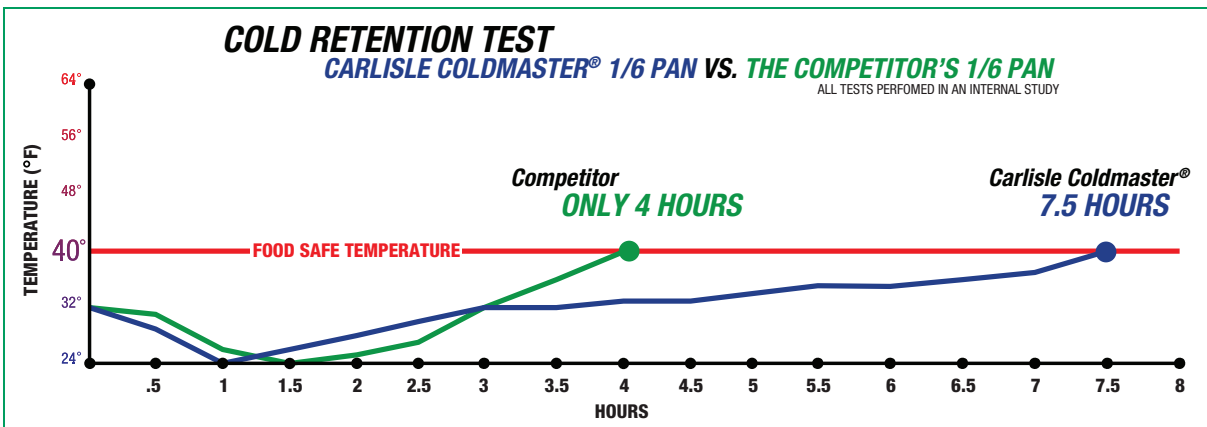

Coldmaster line includes a full suite of **COLD RETENTION SOLUTIONS** such as 3 gallon ice-cream servers, condiment bars and industry firsts such as CoolCheck™ and Designer pans

- Exclusive refrigerant gel ensures **HIGH PERFORMANCE**
- NON-TOXIC** gel receives a cold "charge" when frozen overnight, which enables it to keep your food cold throughout the day
- Extra insulation surrounds refrigerant gel for **MAXIMUM COLD RETENTION**
- Refrigerant gel is enclosed in a bag; **PREVENTS LEAKS**, even if shell is damaged, ensures 100% coverage and helps keep it in place

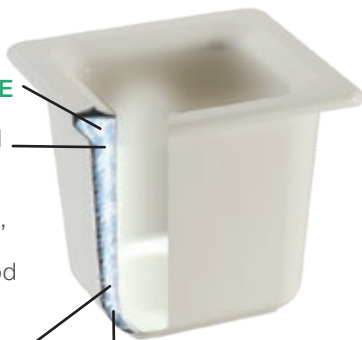

# VS.

### Competitor



- Gel is not enclosed in a bag, less protection if there is a break
- Units must be stored upside down or food in the unit is not chilled at the top of the pan
- No additional insulation means that there is much less "chill time"
- Limited Assortment



# COLDMASTER®

## Coldmaster = Peace of Mind

Coldmaster products are available in a variety of shapes and sizes from food pans to crocks, to ice cream servers. Coldmaster offers peace of mind while it keeps your food cold and fresh. Enjoy the convenience of Coldmaster, as it allows you to transport and keep food cold, anywhere you need to without messy ice or electricity.

### Coldmaster Products Exceed Health Department Requirements

- With one overnight charge in your freezer, each Coldmaster keeps food at or below the ServSafe®\* guidelines of 40°F for up to eight hours\*\*

### Coldmaster Products Meet FDA Standards

- All Coldmaster products are filled with an exclusive non-toxic refrigerant gel
- Constructed of high-impact ABS plastic
- Dishwasher safe



## Coldmaster® Whipped Cream & 1 Quart Carton Chillers

- Chillers use the same technology as standard Coldmaster pans
- CM1107 is designed to hold a standard 1qt carton; keeps dairy/egg cartons cold up to 8 hours\*\*
- CM1108 is designed to hold a whipped cream can and provide food-safe chilling for up to 8 hours\*\*
- NSF Listed



Prod No	Description	Color	Pack
<b>Coldmaster Chillers</b>			
CM1107 <b>Δ</b>	1 Quart Carton Chiller	02, 03	1 ea
CM1108 <b>Δ</b>	Whipped Cream Can Chiller	02, 03	1 ea

NSF Listed products are designated with a **Δ** and may be prefixed with an N

\*ServSafe is a registered trademark of the National Restaurant Association

\*\*Temperature retention is based on crocks being pre-frozen for a minimum of eight hours, then filled directly with pre-chilled foods. Testing was conducted under ambient room temperatures of 76°F.





## Standard Food Pans & Lids

- Designed to fit in standard sized food pan templates
- Save time and labor by placing food directly into Coldmaster Standard Pans
- Third-size divided splits into two sixth-size food pans
- NSF Listed



## Coldmaster Lids

- Designed to fit Coldmaster Standard Food Pans
- Clear acrylic lid protects against contaminants
- Helps maintain cold temperatures so your food stays fresh longer
- Molded-in handle allows easy removal



Prod No	Description	Color	Pack
<b>Coldmaster Standard Food Pans &amp; Lids</b>			
CM1100 $\Delta$	6" Deep Full-size Food Pan	02, 03	1 ea
CM1101 $\Delta$	6" Deep Half-size Food Pan	02, 03	1 ea
CM1102 $\Delta$	6" Deep Third-size Food Pan	02, 03	1 ea
CM1103 $\Delta$	6" Deep Third-size Divided Food Pan	02, 03	1 ea
CM1104 $\Delta$	6" Deep Sixth-size Food Pan	02, 03	1 ea
CM1105 $\Delta$	6" Deep High Capacity Sixth-size Food Pan	02, 03	1 ea
CM1125	Full-size Coldmaster Lid	07	2 ea
CM1126	Half-size Coldmaster Lid	07	2 ea
CM1127	Third-size Coldmaster Lid	07	2 ea
CM1128	Sixth-size Coldmaster Lid	07	2 ea

NSF Listed products are designated with a  $\Delta$  and may be prefixed with an N



# COLDMASTER®

Carlisle's EZ Access Lids were designed in **collaboration** with the people who **use our products everyday.**

## Coldmaster EZ Access Lids

- Lids fit standard Coldmaster Food Pans shown on page 111
- Snug fit ensures they won't pop off, even when leveling a measure miser on the sidewall
- Innovative design includes lipped notches that allow the lid to be opened with a simple flick of the wrist or serving utensil
- Raised design allows maximum fill of your food pan
- Easy-clean design eliminates food traps and allows for easy cleanability
- Convenient hang hole for easy storage when not in use
- NSF Listed

## Pan/Organizer with PC Food Pans and EZ Access Lids



CM1049



CM10280Z

CM103190Z



CM10240Z

Clear(07)

Prod No	Description	Color	Pack
<b>Coldmaster EZ Access Lids</b>			
CM10238Z ▲◆	1/2 Size Lid	07	2 ea
CM10239Z ▲◆	1/2 Size Lid with Notch	07	2 ea
CM10240Z ▲◆	1/2 Size Lid with 2 Notches	07	2 ea
CM10278Z ▲◆	1/3 Size Lid	07	2 ea
CM10279Z ▲◆	1/3 Size Lid with Notch	07	2 ea
CM10280Z ▲◆	1/3 Size Lid with 2 Notches	07	2 ea
CM10318Z ▲◆	1/6 Size Lid	07	2 ea
CM10319Z ▲◆	1/6 Size Lid with Notch	07	2 ea

NSF Listed products are designated with a ▲ and may be prefixed with an N

◆ California Residents: Bisphenol A **WARNING:** See appendix A on page 1



The **safest and most convenient** way to keep foods held in metal pans cold for **up to 8 hours** during outdoor or off-site events. Coldmaster Coldpans allow your operation to keep **limited-time-offer items** chilled **without having to expand your cold well.**

**Pan/Organizer with standard Food Pans**



**Coldmaster Coldpans**

- Designed with the same capacity as traditional style food pans; will hold DuraPan™ Food Pans (pages 224-225)
- Holds and keeps standard food pans cold
- CM1049 Pan Organizer is a 6" deep full size coldpan designed to hold (9) ninth-size food pans for easy organization
- NSF Listed, dishwasher safe



Prod No	Description	Color	Pack
<b>Coldmaster Coldpans</b>			
CM1042 $\Delta$	6" Deep Full-size Coldpan (will hold full, third or half size pans)	02, 03	1 ea
CM1040 $\Delta$	4" Deep Full-size Coldpan (will hold full, third or half size pans)	02	1 ea
CM1042LP	Full Size Coldpan Lid (fits CM1040, CM1042 and CM1049)	02	1 ea
CM1043 $\Delta$	6" Deep Half-size Long Coldpan (will hold 1 half-long pan)	02	1 ea
CM1045 $\Delta$	6" Deep Third-size Coldpan (will hold third, sixth or ninth size pans)	02	1 ea
CM1046 $\Delta$	6" Deep Two-Thirds size Coldpan (will hold two-third or third size pans)	02	1 ea
<b>Coldmaster Pan/Organizer</b>			
CM1049	6" Deep Full-size Coldpan with Organizer (does not include food pans)	02	1 ea

NSF Listed products are designated with a  $\Delta$  and may be prefixed with an N



# COLDMASTER®

The decorative styling of Designer Coldmaster allows **complete versatility**. Designer has all the features of our regular Coldmaster products, but with a **premium design** that looks good on a buffet, salad bar or any tabletop presentation.

## Designer Coldmaster

- High-impact ABS material stands up to rigorous use
- Eliminates the labor needed to refill unsanitary ice baths and reduces food waste by keeping food chilled
- Holds food temperatures at or below the ServSafe®\*\* temperature of 40°F for up to four hours†
- Keeps salads fresh and crisp for hours
- Provides a classy look for bar toppings
- Clear polycarbonate lids (sold separately) help preserve food freshness
- Crocks are NSF listed and dishwasher safe



CM140102



CM1408

CM1405



CM1401440

CM1400443

CM140003

CM1400442\*

CM1402444

CM1400439\*

CM140002

\*Special order colors require a MOQ of 400 pieces and 3 weeks lead time for production.

\*\*ServSafe® is a registered trademark of the National Restaurant Association

† Temperature retention is based on Coldmaster being pre-frozen for a minimum of eight hours, then filled directly with pre-chilled foods. Testing was conducted under ambient room temperatures of 76°F



## Ice Cream Server & Lid

- Coldmaster technology and benefits (see pages 108-109)
- Accommodates standard 3-gallon ice cream tubs
- FREE, clear polycarbonate lid included with each Coldmaster Ice Cream Server
- Replacement Lids (CM1013) also available



CM1012

## Ice Cream Shroud

- Attractive stainless steel cover offers an upscale appearance



CM1012 with 38655 Shroud

White/White(02)	Black/Black(03)	Clear(07) Lids Only	White/Pewter(440)	Black/Charcoal(444)
White/Champagne(439)*	White/Charcoal(441)*	Black/Champagne(442)*	Black/Pewter(443)*	

Prod No	Description	Color	Pack
<b>Designer Coldmaster – Stocked</b>			
CM1400 $\Delta$	1 qt Flared Square	02, 03, 440, 444	1 ea
CM1401 $\Delta$	2 qt Flared Square	02, 03, 440, 444	1 ea
CM1402 $\Delta$	5 qt Oval	02, 03, 440, 444	1 ea
<b>Designer Coldmaster – Special Order*</b>			
CM1400 $\Delta$	1 qt Flared Square	439, 441, 442, 443	1 ea
CM1401 $\Delta$	2 qt Flared Square	439, 441, 442, 443	1 ea
CM1402 $\Delta$	5 qt Oval	439, 441, 442, 443	1 ea
<b>Designer Coldmaster Lids</b>			
CM1403 $\diamond$	1 qt Lid Solid (fits CM1400)	07	1 ea
CM1404 $\diamond$	1 qt Lid Notched (fits CM1400)	07	1 ea
CM1405 $\diamond$	2 qt Lid Solid (fits CM1401)	07	1 ea
CM1406 $\diamond$	2 qt Lid Notched (fits CM1401)	07	1 ea
CM1407 $\diamond$	5 qt Lid Solid (fits CM1402)	07	1 ea
CM1408 $\diamond$	5 qt Lid Notched (fits CM1402)	07	1 ea
<b>Coldmaster Ice Cream Server, Lid &amp; Shroud</b>			
CM1012 $\Delta$	3 gal Coldmaster Ice Cream Server	02, 03	1 ea
CM1013 $\diamond$	Lid for Coldmaster Ice Cream Server	07	1 ea
38655	Coldmaster Ice Cream Shroud	—	1 ea

NSF Listed Products are designated with a  $\Delta$  and may be prefixed with an N

\*Special order colors require a MOQ of 400 pieces and 3 weeks lead time for production.

$\diamond$  California Residents: Bisphenol A **WARNING:** See appendix A on page 1



# COLDMASTER®

## Coldcrock

- Same Coldmaster technology and benefits (see pages 108-109)
- Crock holds 2 quarts of salad, dressing or condiments
- NSF Listed



## Coldcrock Accessories

- Use Standard Pump (CM1035) with ketchup, mayonnaise, mustard or other sauces; can be used with or without insert to provide accurate .5 ounce or 1 ounce portions
- Fixed Nozzle Pump (38600R) dispenses 1 ounce per stroke; flow back design prevents messy dripping
- Maxi Pump (CM1037) dispenses 1 ounce portions of salsa, dressings and other chunky condiments
- Maxi Pump's long nozzle allows easier dispensing; comes with snap-in nozzle restrictors to help eliminate dripping when dispensing thinner condiments



Prod No	Description	Color	Pack
<b>Coldmaster Coldcrock &amp; Accessories</b>			
CM1030 <b>Δ</b>	2 qt Coldcrock (includes Coaster)	02, 03, 23	1 ea
CM1032	Clear Solid Lid	07	2 ea
CM1033	Clear Slotted Lid	07	2 ea
CM1033P	Clear Pump Lid (use with pumps below)	07	2 ea
CM1035	.5 or 1 oz Standard Pump	02	2 ea
CM1037	1 oz Maxi Pump includes 2 sizes Nozzle Restrictors	02	2 ea
38600R	1 oz Fixed Nozzle Pump	—	1 ea

NSF Listed products are designated with a **Δ** and may be prefixed with an N



## Condiment Bar Organizers

- Condiment organizer available for 3 or 6 qt Coldcrocks
- Organizer is made of sturdy, high-impact plastic
- Textured exterior hides scratches
- Order organizer separately or as a set with crocks, lid and pumps (CM1058)
- Coldcrocks (CM1030) sold separately; see facing page for details



CM1065 with Coldmaster Crocks

## Dispenser

- Coldmaster technology & benefits
- Perfect for milk, cream and other temperature sensitive condiments
- Faucet style dispenser offers better control for dispensing liquids

Find replacement parts at [www.carlislefp.com/replacement-parts](http://www.carlislefp.com/replacement-parts)

CM1017



Prod No	Description	Color	Pack
<b>Coldmaster Condiment Bar Organizers</b>			
CM1058	Crock & Organizer Condiment Set (3-Crock Coldcrock Organizer and 3 ea Coldmaster Crocks, Pump Lids and Condiment Pumps)	02	1 set
CM1065	6-Crock Coldcrock Organizer (only)	02	1 ea
CM1069	3-Crock Coldcrock Organizer (only)	02	1 ea
<b>Coldmaster Dispenser</b>			
CM1017	5 qt Coldmaster Milk Dispenser & Lid	03	1 ea



# CROCKS

Coordinate with colorful quality crocks from Carlisle. We've got the **durability, beauty and value** you are looking for in a variety our competitors can't beat. Each style has its own features and benefits so you can **select the crock that best suits your needs.**



## Classic

- Thick-walled, heavy-weight design; made of SAN
- Chemical resistance to food acids and dressings
- High-gloss finish is extremely scuff-resistant
- 0°F to 180°F temperature range
- 0.6 quart crock fits inside 1.2 quart crock for smaller portions
- Translucent snap-on lids included
- NSF Listed; dishwasher safe

## Poly-Tuf™

- Optimum wall design gives greater break-resistance
- Glossy-finish crocks resist chipping and cracking
- Withstands temperatures from 32°F to 180°F
- Translucent snap-on lids included
- NSF Listed; dishwasher safe



Prod No	Description	Color	Pack
<b>Classic Crocks</b>			
0300 $\Delta$	0.6 qt Classic Crock with Lid	03	12 ea
0301 $\Delta$	1.2 qt Classic Crock with Lid	01, 02, 03, 06, 07	12 ea
0316 $\Delta$	1.5 qt Classic Crock with Lid	01, 03, 06, 07	6 ea
0302 $\Delta$	2.7 qt Classic Crock with Lid	01, 02, 03, 06, 07	6 ea
0304 $\Delta$	4.0 qt Classic Crock with Lid	03	6 ea
<b>Poly-Tuf Crocks</b>			
0341 $\Delta$	1.2 qt Poly-Tuf Crock with Lid	01, 03, 06	12 ea
0343 $\Delta$	1.5 qt Poly-Tuf Crock with Lid	01, 03, 06	6 ea
0342 $\Delta$	2.7 qt Poly-Tuf Crock with Lid	01, 03, 06	6 ea
<b>Replacement Lids For Classic &amp; Poly-Tuf Crocks</b>			
0311 $\Delta$	Lid - 0.6/1.2 qt (fits 0300, 0301, 0341)	30	12 ea
0202 $\Delta$	Lid - 1.5/2.7 qt (fits 0302, 0316, 0342, 0343)	30	6 ea
0602 $\Delta$	Lid - 4 qt (fits 0304)	30	12 ea

NSF Listed products are designated with a  $\Delta$  and may be prefixed with an N





## Supreme

- Same features as our Classic Crock, but with a 1.5" deep rim
- Gives a stylish bowl-like appearance when dropped into food bar templates
- 6.5" diameter (under rim) fits most template openings
- Translucent snap-on lids included
- NSF Listed; dishwasher safe



## Gourmet

- Unique bowl shaped rim with deep crock base
- Stylish frosted pattern on rim helps hide scratches
- Break-resistant polycarbonate takes heat up to 212°F
- Translucent snap-on lids included
- NSF Listed; dishwasher safe



Find replacement parts at [www.carlislefsp.com/replacement-parts](http://www.carlislefsp.com/replacement-parts)



Prod No	Description	Color	Pack
<b>Supreme Cocks</b>			
0365 $\Delta$	1.5 qt Supreme Crock with Lid	03, 07	6 ea
0372 $\Delta$	2.7 qt Supreme Crock with Lid	03	6 ea
0202 $\Delta$	Replacement Lid - 1.5/2.7 qt (fits 0365, 0372)	30	12 ea
<b>Gourmet Cocks</b>			
7039 $\Delta$	Gourmet Crock with Lid	03, 07	6 ea
7038 $\Delta$	Replacement Lid	30	12 ea

NSF Listed products are designated with a  $\Delta$  and may be prefixed with an N



# COLOR-COORDINATED ACCESSORIES

Carlisle has the **largest selection of color coordinated accessories** to complement our Food Bar, Buffet and Deli Items. **One-piece construction** makes Carlisle accessories more **durable and easier to clean**. Carlisle offers color-coordinated accessories for every kitchen application from **high heat to portion control**.

## Tongs

### Carly® Tongs

- Carries a two-year limited warranty
- Made of revolutionary plastic material for strength and longevity
- Can be used on high temperature surfaces like steam tables
- Withstands heat up to 212°F
- NSF Listed; dishwasher safe



### Clear Carly Tongs

- Break-resistant polycarbonate
- Recommended for temperatures up to 212°F
- NSF Listed; dishwasher safe



Prod No	Description	Color	Pack
<b>Carly Tongs</b>			
4606 <span style="color: green;">▲</span>	6" Carly Salad Tong	01, 02, 03, 05, 06	12 ea
4609 <span style="color: green;">▲</span>	9" Carly Salad Tong	01, 02, 03, 05, 06, 08	12 ea
4709 <span style="color: green;">▲</span>	9" Carly Utility Tong	01, 02, 03, 05, 06, 08	12 ea
4712 <span style="color: green;">▲</span>	12" Carly Utility Tong	01, 02, 03, 05, 06	12 ea
4806 <span style="color: green;">▲</span>	6" Carly Pom Tong	01, 03, 06	12 ea
<b>Clear Carly Tongs</b>			
4006 <span style="color: green;">▲</span>	6" Carly Salad Tong	07	12 ea
4009 <span style="color: green;">▲</span>	9" Carly Salad Tong	07	12 ea
4109 <span style="color: green;">▲</span>	9" Carly Utility Tong	07	12 ea
4206 <span style="color: green;">▲</span>	6" Carly Pom Tong	07	12 ea

NSF Listed products are designated with a ▲ and may be prefixed with an N



## Ladles

### Carly Ladles

- Two-year limited warranty
- 1 ounce, oval-shaped bowl allows pouring from both sides
- Available in 9.5" and 13.5" lengths
- NSF Listed; dishwasher safe

### Standard Ladles

- Two-year limited warranty
- .75 ounce bowl with spouts on each side for easy pouring
- Available in 10.5" length
- NSF Listed; dishwasher safe

### Serving Spoons, Buffet Spoons & Pasta Forks

- Two-year limited warranty
- Recommended for temperatures up to 212°F
- Withstands dry heat up to 270°F
- Serving Spoons have notch in handle so spoon can rest on edge of food pan
- NSF Listed; dishwasher safe

### Salad Spoon

- Large flat edge for easy scooping
- 7.25" handle for easy reach
- Durable SAN material
- NSF Listed; dishwasher safe



Brown(01)	White(02)	Black(03)	Red(05)	Beige(06)	Clear(07)	Forest Green(08)
-----------	-----------	-----------	---------	-----------	-----------	------------------

Prod No	Description	Color	Pack
<b>Ladles</b>			
0295 $\Delta$	9.5" Carly Ladle	01, 02, 03, 05, 06, 07	12 ea
0296 $\Delta$	13.5" Carly Ladle	03	12 ea
0287*	9.5" Carly Ladle (Assorted Imprinted)	03	1 set
0240 $\Delta$	10.5" Standard Ladle	03, 07	48 ea
0261*	10.5" Standard Ladle (Assorted Imprinted)	03	1 set
<b>Spoons &amp; Pasta Fork</b>			
4410 $\Delta$	11" Solid Serving Spoon	02, 03, 05, 06, 07, 08	12 ea
4411 $\Delta$	11" Perforated Serving Spoon	03, 07	12 ea
4420 $\Delta$	13" Solid Serving Spoon	02, 03, 05, 06, 07	12 ea
4421 $\Delta$	13" Perforated Serving Spoon	03	12 ea
4430 $\Delta$	15" Solid Serving Spoon	03, 07	12 ea
4431 $\Delta$	15" Perforated Serving Spoon	03	12 ea
4450 $\Delta$	.25 oz, 8" Solid Buffet Spoon	03, 06, 07	12 ea
4460 $\Delta$	.5 oz, 8" Solid Buffet Spoon	01, 02, 03, 05, 06, 07, 08	12 ea
4470 $\Delta$	.75 oz, 10" Solid Buffet Spoon	01, 03, 05, 06, 07	12 ea
4471 $\Delta$	.75 oz, 10" Perforated Buffet Spoon	01, 03, 06	12 ea
4355	9.5" Pasta Fork	03	12 ea
509 $\Delta$	11" Salad Spoon	01, 03	48 ea

NSF Listed products are designated with a  $\Delta$  and may be prefixed with an N  
 Note:\*Assortment Packs includes one each of Bleu Cheese, Lo-Cal, Italian, House, French, Ranch, Thousand Island, & Caesar, plus four plain Imprinted Ladles: Handle imprinted in white with dressing name



# FOOD BARS

The Maximizer Food Bar enables you to **serve food anywhere!** Perfect for use with Coldmaster® Food Pans to keep food **below 40° for up to 8 hours.**

7711

## Maximizer™ Food Bar

- 6 foot Maximizer Food Bar offers upscale European styling
- Use with ice or with Coldmaster® Standard Food Pans to keep food at 40°F or below for up to eight hours
- Double-sided, acrylic sneeze guard attaches to post with six screw-in knobs
- Basin and cabinet come assembled (no tools required)
- Tilting sneeze guard makes it easier to clean and fill food bar and can be used as a service line sandwich bar
- NSF Listed



Tilting sneeze guard



Holds six full size food pans (20% more than any other similar system)

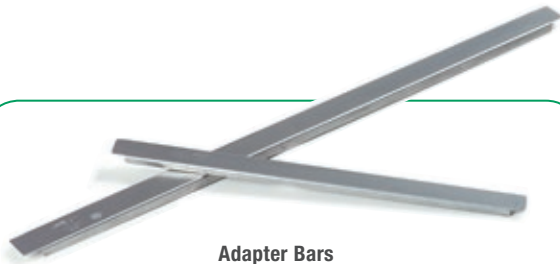

**Adapter Bars**

Use with various food pans to set up a number of food bar configurations, see page 225 for more information

**Maximizer Food Bar Coupon Available**  
[www.carlislefsp.com/ecoupons](http://www.carlislefsp.com/ecoupons)

**Find replacement parts at**  
[www.carlislefsp.com/replacement-parts](http://www.carlislefsp.com/replacement-parts)

**Molded from durable polyethylene and filled with thick polyurethane foam to keep food at correct serving temperatures for hours**



Prod No	Description	Color	Pack
<b>Maximizer Food Bar &amp; Accessories</b>			
7711 $\Delta$	6 ft Maximizer Food Bar	01*, 03, 08*, 59*	1 ea
7721 $\Delta$	6 ft Maximizer Tray Slide	01*, 03, 08, 59	1 ea
7725 $\Delta$	Maximizer End Shelf	01, 03, 08*, 59*	1 ea

NSF Listed products are designated with a  $\Delta$  and may be prefixed with an N

\* Color available by special order only





# FOOD BARS

Features **high-tech coating** to keep the Six★Star Food Bar **looking great for years** to come and provides **easy clean up**.

## Six★Star™ Food Bars

- Molded with thick polyurethane foam for hours of insulation
- Use with ice or with Coldmaster® Standard Food Pans to keep food at 40°F or below for up to eight hours
- Two-piece acrylic shields allow for easy assembly
- Specially coated finish gives a beautiful glossy sheen and makes clean up easier
- Faucet-type drain plug facilitates water removal
- Add tray slides and end shelves without removing legs
- Sturdy, recessed, 5" non-marking swivel casters, two with brakes
- Easy to assemble
- NSF Listed



6605 with 6620 Tray Slide

### Portable Food Bars

- Legs only unit available in 4 or 6 foot models



6608 with 6621 Tray Slide

### Youth Bar

Set up a Sundae Station using our Cold Master 3 gallon Ice Cream Server and crocks filled with all the fixins'

- Low 29" serving height is designed for young people to conveniently reach all condiments



6600

### Tabletop Bars

Perfect for a Happy Hour Bar!

- Threaded drain plug underneath ice pan for easy water removal

6611 with 6621 Tray Slide 6625 End Shelf





**Portable Enclosed Bars**

- 6 foot unit with enclosed storage unit and sliding doors

Find replacement parts at  
[www.carlislefsp.com/replacement-parts](http://www.carlislefsp.com/replacement-parts)



Prod No	Description	Color	Pack
<b>Six★Star Food Bars &amp; Accessories</b>			
6600 <b>Δ</b>	4 ft Six★Star Tabletop	01*, 03, 05*, 08*	1 ea
6601 <b>Δ</b>	6 ft Six★Star Tabletop	03	1 ea
6605 <b>Δ</b>	4 ft Six★Star Portable with Legs only	01*, 03, 08*	1 ea
6606 <b>Δ</b>	6 ft Six★Star Portable with Legs only	01*, 03, 08*	1 ea
6611 <b>Δ</b>	6 ft Six★Star Portable with Storage & Legs	03, 08*	1 ea
6608 <b>Δ</b>	6 ft Six★Star Youth with Legs only	03, 05*, 08*	1 ea
6620 <b>Δ</b>	4 ft Six★Star Tray Slide (fits 6605)	01, 03, 08*	1 ea
6621 <b>Δ</b>	6 ft Six★Star Tray Slide (fits 6606, 6608, 6611)	01*, 03 05*, 08*	1 ea
6625 <b>Δ</b>	Six★Star End Shelf (fits all Six★Star Food Bars)	01*, 03, 05*, 08*	1 ea

NSF Listed products are designated with a **Δ** and may be prefixed with an N

Note: 6621 can ship UPS/FedEx Ground at oversize cost; 6600, 6601, 6608, 6611, 6605, 6606 cannot ship UPS/FedEx Ground

Note: 6600, 6601 tabletop units cannot be converted to portable units

\* Color available by special order only



# FOOD BARS & ACCESSORIES

Set up a counter top buffet pasta or salad station at your next event.  
**Perfect for happy hour in the bar!**

## Five★Star™ Buffet Bars

- Thick polyurethane foam insulation holds ice for hours
- Great with crocks, bowls or icing down beverages
- Drain plug at end of unit
- NSF Listed



7670 with 9720 Sneeze Guard

Find replacement parts at  
[www.carlislefsp.com/replacement-parts](http://www.carlislefsp.com/replacement-parts)



Prod No	Description	Color	Pack
<b>Five★Star Buffet Bars</b>			
7670 $\Delta$	4 ft Five★Star Buffet Bar	01, 03, 08*	1 ea
7671 $\Delta$	6 ft Five★Star Buffet Bar	01*, 03	1 ea
<b>Free Standing Single-Sided Sneeze Guards</b>			
9148 $\Delta$	48" Standard Single-Sided	03, 07	1 ea
9160 $\Delta$	60" Standard Single-Sided	03, 07	1 ea
9172 $\Delta$	73.25" Standard Single-Sided	03, 07	1 ea
9224	24" Adjustable Single-Sided	03, 07	1 ea
9248	48" Adjustable Single-Sided	03, 07	1 ea
9260	60" Adjustable Single-Sided	03, 07	1 ea
9272	73.25" Adjustable Single-Sided	03, 07	1 ea
<b>Free Standing Double-Sided Sneeze Guards</b>			
9710	48" Standard Double-Sided	03	1 ea
9712	73.25" Standard Double-Sided	03	1 ea
9720	48" Adjustable Double-Sided	03	1 ea
9722	73.25" Adjustable Double-Sided	03	1 ea
<b>Sneeze Guard Accessories</b>			
9051	Single End Panel (encloses side area on Single Sneeze Guard)	07	1 pr
9052	Double End Panel (encloses side on Double-Sided Sneeze Guard)	07	1 ea

NSF Listed products are designated with a  $\Delta$  and may be prefixed with an N

Sneeze guards not recommended for use with steam tables

Shipping Notes: 7671 cannot be shipped UPS/FedEx Ground; 7670 can ship at oversize cost

9160, 9172, 9260, 9272, 9712 cannot be shipped UPS/FedEx Ground; 9148, 9248, 9710, 9720 can ship at oversize cost

\* Color available by special order only





### Sneeze Guards

- Designed to fit Five★Star Buffet Bars
- 9148, 9160, 9172 are NSF Listed



9260



9148

### Pastry Display Cases

- Display pies, cookies and cakes
- Slide-in trays are textured to resist scratching
- Made of sanitary, easy-to-clean acrylic
- Convenient hinged door with magnetic closure



SPD303KD

Clear(07)

Prod No	Description	Color	Pack
<b>Pastry Display Cases</b>			
SPD300	Three Tray (Back Door)	07	1 ea
SPD300KD	Three Tray (Back Door) (unassembled)	07	1 ea
SPD303	Three Tray, Self Serve Front & Back Door	07	1 ea
SPD303KD	Three Tray, Self Serve Front & Back Door (unassembled)	07	1 ea
SPD123	Tray Only	07	1 ea

Pastry Display Cases listed above can be shipped UPS/FedEx Ground at oversize cost with the exception of SPD123 shipping at standard rate



# CONDIMENT SOLUTIONS

## Packet Racks

- Packet Racks hold all types of condiment packets, utensils, straws, napkins and take up very little counter space
- Choose between a sturdy aluminum frame or an economical chrome wire frame
- Durable plastic containers have a drop-in card holder molded into the front
- Unit comes with a set of 31 common label cards for organizing and identifying contents
- For use on counter or mount to wall with screws (included)



381206LG



381109LG

## Food Stations

### Condiment Food Station

- 10806 Condiment Station includes (4) sixth-size 6" deep, StorPlus™ polycarbonate black food pans
- Can also hold (4) sixth-size Coldmaster® standard food pans sold separately on page 111

### Multi-Purpose Food Station

- 10807 Multi-Purpose Station includes (4) third-size 4" deep, StorPlus™ polycarbonate black food pans
- Can also hold (4) third-size Coldmaster® standard food pans sold separately on page 111



10806

10807

## Standard Pump Kit

- 38310 Includes Standard Pump and the following 5 lid sizes: 1.5", 4.31", 4.31"SP, 4.69" and 6.31"
- Pump and lid sets screw or snap on allowing you to pump condiments directly from their containers
- Standard Plastic Pump has 2 restrictor clips for dispensing either .5 or 1 ounce portions



38310

Find replacement parts at [www.carlislefsp.com/replacement-parts](http://www.carlislefsp.com/replacement-parts)

Black(03)

**Prod No**    **Description**

**Color**

**Pack**

**Packet Racks**

381109LG    Aluminum Packet Rack, comes with 9 ea 3.5 qt containers

—

1 ea

381206LG    Wire Packet Rack, comes with 6 ea 4 qt containers

—

1 ea

**Food Stations**

10806 ♦    Condiment Food Station (includes 4ea Sixth Size Food Pans)

03

1 ea

10807    Multi-Purpose Food Station (includes 4ea Third Size Food Pans)

03

1 ea

**Standard Pump Kit**

38310    Standard Pump Kit

—

6 ea

♦ California Residents: Bisphenol A    **WARNING:** See appendix A on page 1



Carlisle topping rails, made of long lasting stainless steel, are perfect for dispensing condiments, dressings and sauces.

### Standard Topping Rails

- Economical Standard Plastic Pump comes with 2 restrictor clips for dispenses either .5 or 1 ounce portions
- Removable pumps and jars included
- Rubber feet protect counter and slipping



38502

### Insulated Topping Rails

- Insulated unit combines with reusable ice packs to keep condiments chilled for hours
- Includes reusable ice packs, 2 quart containers, pumps and self-adhesive labels of most popular condiments
- 2 quart containers include snap-on lids for overnight storage
- Choose between patented\* Stainless Steel Pump or economical Standard Pump
- Stainless Steel Pump dispenses 1.25 ounces per stroke; Standard Pump dispenses .5 or 1 ounce portions



386230IB



386231B

### High Volume Condiment Pumps

- Holds gallon jars or #10 cans for clean look
- Choose between patented\* Stainless Steel Pump or Fixed Nozzle Pump
- Stainless Steel Pump dispenses 1.25 ounce per stroke; Standard Pump dispenses .5 or 1 ounce portions



386010



38601

Find replacement parts at [www.carlislefsp.com/replacement-parts](http://www.carlislefsp.com/replacement-parts)

Prod No	Description	Pack
<b>Standard Pump Topping Rails</b>		
38502	Topping Rail with 2 ea Standard Pumps & Jars	1 ea
38503	Topping Rail with 3 ea Standard Pumps & Jars	1 ea
38504	Topping Rail with 4 ea Standard Pumps & Jars	1 ea
<b>Insulated Topping Rails</b>		
386230IB	Insulated Topping Rail with 3 ea Stainless Steel Pumps & 2 Large Ice Packs	1 ea
386231B	Insulated Topping Rail with 3 ea Standard Pumps & 2 Large Ice Packs	1 ea
<b>High Volume Condiment Pumps</b>		
386010	High Volume Condiment Pump with Stainless Steel Pump	1 ea
38601	High Volume Condiment Pump with Fixed Nozzle Pump	1 ea

\*US Patent Nos. 6343720, 6019256, 6450373



# CUP & LID DISPENSERS

## Adjustable Cup Dispensers

- One dispenser to fit all standard sizes of foam, paper or plastic drink cups from 8 to 48 ounces
- Vertical Cabinet Models are made of rugged stainless steel
- Spring-loaded with silicone release gaskets
- Comes with four interchangeable gaskets per tube (small, medium, large and extra large)
- No tools required; ready to use



38800GLC



38882G

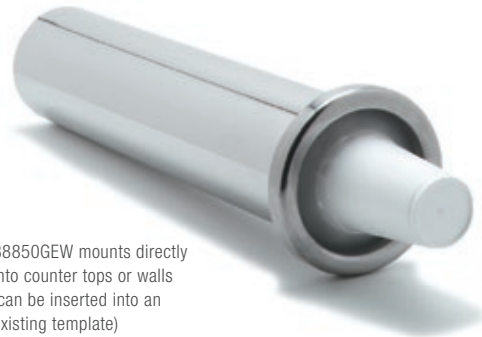

38850GEW mounts directly into counter tops or walls (can be inserted into an existing template)

38883G



38884G



38820C



38830C

## Gravity Feed Cup Dispensers

- Adjusts easily to fit various sizes of foam, paper or plastic cups
- Mounts on walls and includes 2-piece quick-release side mount bracket

Prod No	Description	Pack
<b>Adjustable Cup Dispensers</b>		
38882G	2 Cup Dispenser, Vertical Cabinet Model	1 ea
38883G	3 Cup Dispenser, Vertical Cabinet Model	1 ea
38884G	4 Cup Dispenser, Vertical Cabinet Model	1 ea
38850GEW	Cup Dispenser only	1 ea
<b>Gravity Feed Cup Dispensers</b>		
38820C	Small Cup Dispenser, holds 6-11 oz, 2.5" - 3.44" cups	1 ea
38830C	Large Cup Dispenser, holds 12-24 oz, 3.38" - 3.88" cups	1 ea



### Lid & Condiment Organizer

- Stainless Steel Organizer mounts on top of Vertical Cup Dispenser Cabinets or can be used on counter tops
- Rubber feet prevent slipping and protect counter
- Includes (2) pint & (3) quart plastic inserts



### Counter Top Lid & Straw Dispenser

- Dividers adjust to accommodate all standard size lids
- Straw panel is removable for additional lid storage
- Rubber feet protect counter tops
- Dispenser can be wall mounted on two standard key-lock holes



### 6-Compartment Condiment Caddy

- Compact 8" x 14" size fits counter tops and coffee cabinets with limited space
- Stepped design with deep compartments for organizing condiments
- Durable ABS plastic with textured finish hides scratches



### Dispensers

- Sliding tops for easy loading

#### Toothpick Dispenser

- Holds standard box of toothpicks
- Security cable prevents theft

#### Straw Dispenser

- Holds a full box of regular or jumbo unwrapped straws up to 8.5" long
- Easy turn knob dispenses one straw at a time

Find replacement parts at [www.carlislefsp.com/replacement-parts](http://www.carlislefsp.com/replacement-parts)



Prod No	Description	Color	Pack
<b>Lid &amp; Condiment Organizer</b>			
38800GLC*	Lid/Condiment Organizer	—	1 ea
<b>Counter Top Lid &amp; Straw Dispenser</b>			
388804L	4 Station Counter Dispenser	—	1 ea
<b>6-Compartment Condiment Caddy</b>			
10828	6-Compartment Coffee Service Condiment Caddy	03	12 ea
<b>Dispensers</b>			
TP100	Toothpick Dispenser	07	1 ea
SSD100	Straw Dispenser	07	1 ea

\*Product available by special order only



# BEVERAGE SERVICE

Perfect for restaurants and cafeterias!

## TrimLine™ Rectangular Beverage Dispensers

- Sleek rectangular design saves valuable counter space
- Quart and liter capacity indicators on both sides
- Reservoir has ergonomic handles for a secure grip
- Features textured lid and base
- Hingeless lid minimizes breakage and helps prevent spills
- Removable Drip Tray prevents spills and saves on clean-up time
- Choose super tough crystal clear polycarbonate or economical translucent polypropylene
- Premium Dispenser has deluxe, no-drip, locking faucet
- Economy Dispenser has industry standard, no-drip faucet
- Includes labels: Fruit Punch, Iced Tea, Lemonade, Sweetened Tea and Unsweetened Tea



10857

Find replacement parts at [www.carlislefsp.com/replacement-parts](http://www.carlislefsp.com/replacement-parts)

Black(03)

Prod No	Description	Color	Pack
<b>TrimLine Single Base – Compact 8" width (Includes 1 ea 3 gal dispenser)</b>			
10850 Δ ♦	3 gal Premium (PC) Single Base	03	1 ea
10854 Δ	3 gal Premium (PPY) Single Base	03	1 ea
10852 Δ ♦	3 gal Economy (PC) Single Base	03	1 ea
10856 Δ	3 gal Economy (PPY) Single Base	03	1 ea
<b>TrimLine Double Base – Compact 15.5" width (Includes 2 ea 3 gal dispensers)</b>			
10851 Δ ♦	3 gal Premium (PC) Double Base	03	1 ea
10853 Δ ♦	3 gal Economy (PC) Double Base	03	1 ea
10857 Δ	3 gal Economy (PPY) Double Base	03	1 ea

NSF Listed products are designated with a Δ and may be prefixed with an N  
♦ California Residents: Bisphenol A **WARNING:** See appendix A on page 1

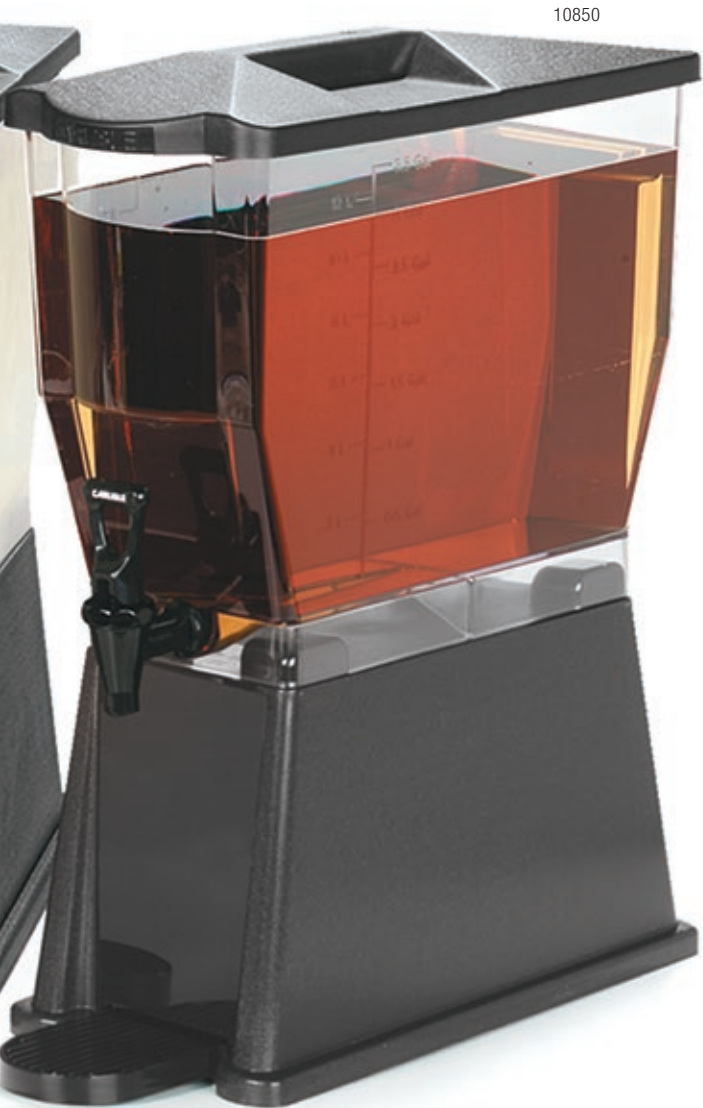

### Square Beverage Dispenser

- Spring action faucet provides fast flow and dripless service

### Round Beverage Dispensers

- Embossed measuring lines in 1-quart increments
- Dispensers and base sold as a unit or dispenser sold separately
- Includes labels for Iced Tea, Lemonade, Fruit Punch, Sweetened and Unsweetened Tea



Prod No	Description	Color	Pack
<b>Square Beverage Dispenser</b>			
10820	3 gal Square (Translucent PPY) Dispenser with Base	03	1 ea
<b>Round Beverage Dispensers With Base</b>			
2230	5 gal Round (White PE) Dispenser with Base	01	1 ea
2229	5 gal Round (Translucent PPY) Dispenser with Base	01, 03	1 ea
2227	3 gal Round (Translucent PPY) Dispenser with Base	01	1 ea
<b>Round Beverage Dispensers</b>			
2210	5 gal Round (White PE) Dispenser	02	1 ea
2209	5 gal Round (Translucent PPY) Dispenser	30	1 ea
2219	3 gal Round (Translucent PPY) Dispenser	30	1 ea



**CARLISLE**  
FOODSERVICE PRODUCTS



# EFFICIENT STURDY INNOVATIVE SANITARY **BAR SUPPLIES**

---

*Carlisle's extensive line of bar supplies enables your serving team to operate a more efficient and profitable bar operation with consistent quality for your patrons. Our efficient, time-saving bar essentials, Store 'N Pour containers and caddy systems save you time and money.*





# MAXIMIZER™ PORTABLE BAR

**Delight your guests and increase revenue.** Maximizer enables you to give your guests the bar service they want and expect. It's great for anything from banquet rooms and hotel lobbies to poolside bars and terrace dining.

Ergonomic 2-step bar and countertop is designed for ease of drink preparation and serving; large surface area keeps condiment caddies within reach without blocking the prep area.

## Maximizer Portable Bar

- Maximizer offers all the style and features you expect in a premium bar at a very affordable price
- Large 56" serving area keeps condiment caddies within reach without blocking prep area
- Durable solidly molded countertop is easy to clean and includes a convenient molded-in bar mat well
- Sturdy 5" non-marking swivel casters with locking brake on each end hold the bar securely in place during use
- 15-gallon ice bin features an integrated drain and water trap
- Ice bin includes a standard dust cover for sanitary storage and transport
- Fully assembled, no tools necessary
- Find replacement parts at [www.carlislefsp.com/replacement-parts](http://www.carlislefsp.com/replacement-parts)

## Maximizer Cover

- Protective 8 gauge vinyl cover keeps bar clean and dry when not in use
- Double vented back secures with hook and loop tape for a custom fit
- Tape fastening allows easy access to bar storage area without removing cover

See our money saving coupon online at [www.carlislefsp.com/ecoupons](http://www.carlislefsp.com/ecoupons)



7555 Protective vinyl cover keeps bar clean and dry when not in use



Vented back for easy access

Designed by bartenders, Maximizer Portable Bar's upscale styling fits in any setting to enable profitable, efficient bar offerings that delight your guests with their favorite libations.



Maximizer Portable Bar's upscale styling is at home in any setting



Durable Maximizer Portable Bar is perfect for outdoor service



Built in cutting board for easy condiment preparation; can be removed for thorough cleaning



Storage compartment includes molded-in rails; use with StorPlus™ 12" x 18" Food Storage Boxes



Includes standard 22" Stainless Steel Speed-Rak™; holds 6 bottles or 6 Store 'N Pour® Quart containers



Unique sliding storage drawer accommodates mixers, sodas or standard bus boxes and can be removed for more versatile storage



Large storage area under the drawer is perfect for staging glassware using our OptiClean™ Glass Racks



Prod No	Description	Color	Pack
7550	Maximizer Portable Bar	03, 44, 094	1 ea
7555 ♦	Maximizer Bar Cover	80	1 ea

Find replacement parts at [www.carlislefsp.com/replacement-parts](http://www.carlislefsp.com/replacement-parts)

Note: 7550 cannot ship UPS/FedEx Ground

♦ California Residents: Di(2-ethylhexyl)phthalate (DEHP) **WARNING:** See appendix B on page 1



# STORE 'N POUR®

## Store 'N Pour

- Enjoy the benefits of the most efficient storing and pouring system for the bar, kitchen or dining room
- Pour a perfect 2-1 drink every time with the patented vented spout design
- Two-piece spout and neck design for easy cleaning
- Exclusive manufacturing process ensures tight seal with no leaks
- Made of high density, break-resistant polyethylene
- Easy clean containers have straight wall design with no sharp interior edges that can collect food or bacteria
- Unique stacking ridge on quart and pint caps make storage on shelf in refrigerator easy and secure
- Color-coordinated spouts and caps for easy product identification
- Lids snap on exclusive, recessed base of pints and quarts to prevent loss
- Assorted cap colors promote color-coding

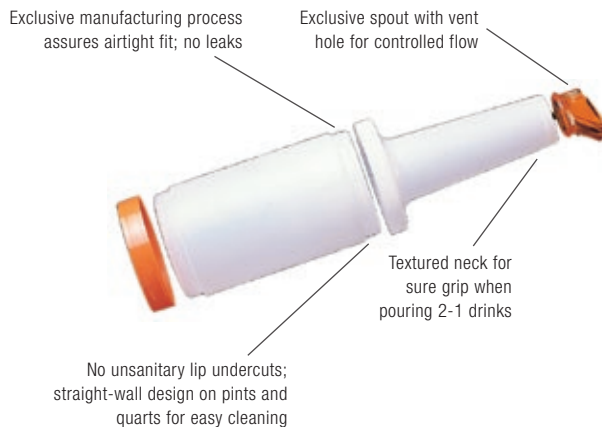

**Back of House Store 'N Pour**  
 Our Store 'N Pour bottles and pourers can also be used in back of the house applications:

- Holding and pouring spices
- Cooking wine/sherry storage and usage

## PourPlus PourPlus Complete

- Complete unit includes container, lid and spout

## PourPlus Spout

- PourPlus fits all Store 'N Pour containers
- Integrated neck and spout designed for fast, free flowing pouring and easy clean-up
- Textured neck provides sure grip—even when wet
- Necks are color-coded



## Store 'N Pour Versatility



Front-of-the-house use



Perfect 2-1 drinks are easy



Stackable backup storage



Back-of-the-house use



Pour batters and oils

Find replacement parts at [www.carlislefsp.com/replacement-parts](http://www.carlislefsp.com/replacement-parts)



Prod No	Description	Color	Pack
<b>Store 'N Pour Speed Spout</b>			
3042	Speed Spout	07	24 ea
<b>Pour Plus Store 'N Pour</b>			
PS204	PourPlus Spout	02, 03	12 ea
PS204AST*	PourPlus Spout, Assorted	00	1 set
PS601NC	Quart Complete	00, 02	12 ea

\*Assorted PourPlus quart packs include 2 each of all colors; half-gallon and gallon assorted packs includes 1 each of all colors

# The Essential Drink Mix System



## 1. Mix In One-Gallon Container

Accurately measure and mix concentrate or powder in gallon containers. Its wide mouth eliminates the need for a funnel.



## 2. Cut Preparation Time

Prepare mixes and juices in advance using the gallon storage container. At peak periods simply empty into a quart backup.



## 3. Transfer To Quarts

Pour a gallon of mix into four easy-to-handle quart containers.



## 4. Ready To Use

Attach neck with spout to one quart for use in speed rack. Cap the remaining three quarts for backup.

## Store 'N Pour Complete Units & Backups

- Complete unit includes neck and container plus color-coordinated pouring spout and cap
- Backup unit includes cap and container
- Dishwasher safe

## Store 'N Pour Speed Spout

- No-drip spout is vented to promote faster, more even flow



3042



## Store 'N Pour Bar Service Pack

Includes six quart complete units (container, neck and color-coordinated spout and cap), 18-quart backup units (container and cap) and 1-gallon backup unit (container with cap) for mixing



PS6012

Assorted(00)	Brown(01)	Black(03)	White(02)	Yellow(04)
Red(05)	Clear(07)	Green(09)	Orange(24)	

Prod No	Description	Color	Pack
<b>Store 'N Pour Complete Units &amp; Backups</b>			
PS501N	Pint Complete	00	12 ea
PS502N	Pint Backup	00	12 ea
PS601N	Quart Complete	00, 01, 02, 04, 05, 09, 24	12 ea
PS602N	Quart Backup	00, 02, 04, 05, 09, 24	12 ea
PS701B	Half-gallon Complete	00	6 ea
PS702	Half-gallon Backup	00	6 ea
PS801B	Gallon Complete	00	6 ea
PS802	Gallon Backup	00	6 ea
PS103	Spouts, Specify Color	01, 04, 05, 07, 24	12 ea
PS103AT	Spout Assortment, 2 ea color	00	12 ea
PS203	Necks	02	12 ea
PS304	Caps, Specify Color	01, 02, 03, 04, 05, 24	12 ea
PS304AT	Caps, Assortment, 2 ea color	00	12 ea
PS603N	Quart, Container Only	02	12 ea
<b>Store 'N Pour Bar Service Pack</b>			
PS6012	Store 'N Pour Bar Service Pack	00	1 set
<b>Store 'N Pour Speed Spout</b>			
3042	Speed Spout	07	24 ea

\*Assorted PourPlus quart packs include 2 each of all colors; half-gallon and gallon assorted packs includes 1 each of all colors



# BOTTLE HOLDERS & CONDIMENT CADDIES

## Stainless Steel Speed-Rak™ Bottle Holders

- Keyhole slots make installation and cleaning easy
- Mounts to bar sink with screws (provided)
- Unique design; single Speed-Raks can be combined to make a double-hung unit



38322BH  
Combine to make a  
double-hung unit

Find replacement parts at  
[www.carlislefsp.com/replacement-parts](http://www.carlislefsp.com/replacement-parts)

Prod No	Description	Pack
<b>Stainless Steel Speed-Rak Bottle Holders</b>		
38322BH	22" Speed-Rak, holds (5) 1-liter bottles	2 ea
38332BH	32" Speed-Rak, holds (8) 1-liter bottles	2 ea
38342BH	42" Speed-Rak, holds (10) 1-liter bottles	2 ea

## Condiment Caddies

### Stainless Steel Caddies

- Rugged stainless steel construction for years of use
- Full size hinged lid units protect condiments from spills and contaminants
- Individual compartment lids keep contents covered when not in use
- Notched lid models available for use with spoons or ladles
- Sanitary pint & quart inserts are easy to clean; (2) pints interchange with (1) quart, allowing you to mix and match to suit your needs



### Stainless Steel Iced Caddies

- Insulated caddies use ice packs to keep condiments chilled and cold for hours without ice or electricity

### Deluxe Caddies

- Solid frosted cover
- Includes caddy and individual containers

### Plastic Caddies

- Solid frosted cover
- Includes caddy and individual containers



White(02)

Prod No	Description	Color	Pack
<b>Stainless Steel Condiment Caddies</b>			
38704CNS	4 qt Condiment Caddies with 4 Lids	—	1 ea
38704CSIB	4 qt Condiment Caddies with 4 Notched Lids & 4 Ice Packs	—	1 ea
38704C	4 pt Condiment Caddies with One-Piece Lid	—	1 ea
38705C	5 pt Condiment Caddies with One-Piece Lid	—	1 ea
38706C	6 pt Condiment Caddies with One-Piece Lid	—	1 ea
<b>Plastic Condiment Caddies</b>			
SS105	Caddy with 5 ea 1.25 Pint Containers/Lids	02	1 ea

# BAR ACCESSORIES

## Bar Caddy

- Ideal bar-top holder that allows quick access to cocktail napkins, stirrers and other accessories
- Break-resistant plastic



## Store 'N Pour® Condiment System

- Condiment system includes tray with cover and six pint containers (PS502N) with assorted caps
- Assorted color caps provide easy identification; caps snap on the bottom for easy storage
- Acrylic covers protect condiments during service



Prod No	Description	Color	Pack
<b>Bar Caddy</b>			
BC05	Bar Caddy	03	12 ea
<b>Store 'N Pour Condiment System</b>			
PS101CS	Complete Condiment System	00	2 ea





## Bar Mat & Service Mat

- Non-slip mats help keep counter tops clean
- Molded-in pattern provides drainage for spilled drinks and wash downs with a sure grip for wet glassware
- Bar Mats have drainage area for jigger, main area holds up to six glasses

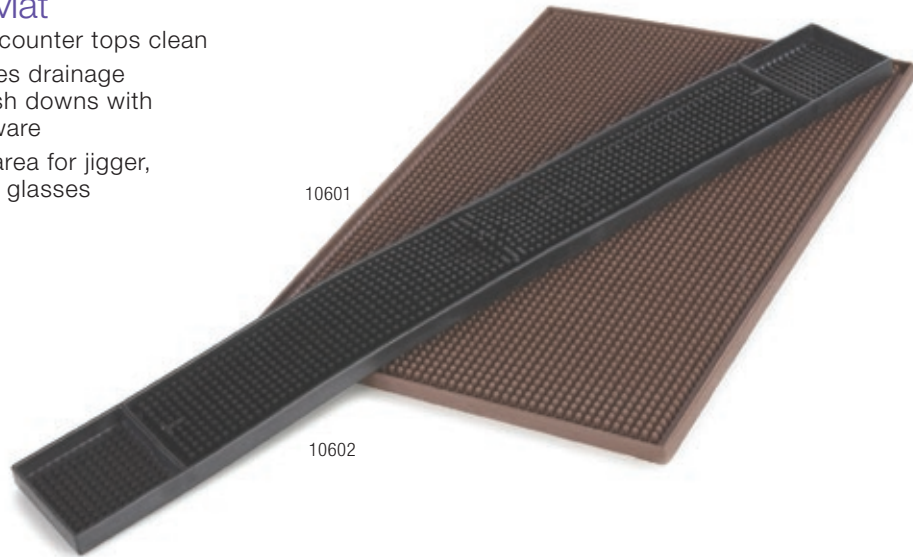

## Bar & Shelf Liner

- Provides skid-resistance and high impact absorption; net pattern allows thorough drainage, promoting rapid, fog-free drying
- Helps prevent bacteria growth
- Resistant to food acids, grease and detergents; conforms to FDA regulations
- Constructed of a firm, resilient plastic

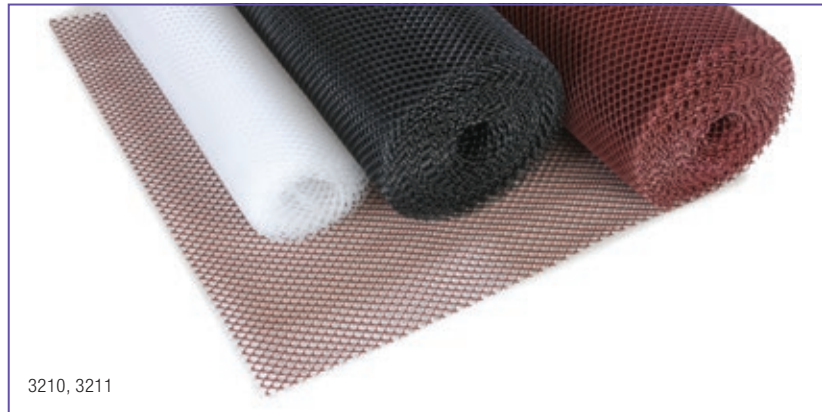

Prod No	Description	Color	Pack
<b>Bar Mat &amp; Service Mat</b>			
10601	12" x 18" Service Mat	01, 03	6 ea
10602	3" x 27" Bar Mat	01, 03	12 ea
<b>Bar &amp; Shelf Liner</b>			
3210	2' x 40' Texliner Roll	01, 03, 07	1 ea
3211	2' x 10' Texliner Roll	03, 07	1 ea



# BAR ACCESSORIES

## Glass Rimmers

### Standard Glass Rimmer

- Two-tier unit provides consistent and even coat of salt

### Combination Salt/Sugar Glass Rimmer

- Three-tier unit allows for application of either salt or sugar



## Portion Control Liquor Pourers

- Carlisle offers portion control pourers in both ounce and metric measurements
- Classic design Portion Pour dispenses exact shots of liquor

### Portion Pour®

- Portion Pour dispenses exact shots of liquor from 1 to 1.5 ounce
- Also available in 20ml metric size



## Pour Free®

- Economical Pour Free for free-flow pouring



Prod No	Description	Color	Pack
<b>Glass Rimmers</b>			
GR09	3-Tier Glass Rimmer	03	12 ea
GR10	2-Tier Glass Rimmer	03	12 ea
<b>Portion Control Liquor Pourers With Red Spout/Black Collar</b>			
EP214	1 oz Portion Pour with Red Base	00	12 ea
EP216	1.25 Portion Pour with Clear Base	00	12 ea
EP217	1.5 oz Portion Pour with Yellow Base	00	12 ea
<b>Pour Free</b>			
OP305	Fluorescent Red Pour Free	00	12 ea
OP316	Black Pour Free	00	12 ea
OP371	Chrome/Black Collar Pour Free	00	12 ea

## Free Flowing Metal Liquor Pourers

- Sturdy metal construction and choice of three flow rates
- Chrome plated for attractive appearance and longer life

### Pourer With Screen

- Metal style pourer with sanitary screen



## Ice Scoops

- 606106 scoop is made of 18-8 rust-free mirror polished stainless steel
- 4306 is made of durable polycarbonate material for long lasting use
- Tapered for easy pouring of ice into glasses
- Both feature a hole for hanging or tying to a container
- Made of durable polycarbonate material for long-lasting use
- See page 199 for a complete listing of Carlisle's scoop line
- NSF Listed; dishwasher safe



Prod No	Description	Color	Pack
<b>Metal Style Free Flowing Pourers</b>			
WPM25	Chrome Tapered with Screen	38	12 ea
WPM85	Chrome Tapered, Medium Flow	38	12 ea
WPM45	Chrome Angled, Super Fast Flow	38	12 ea
<b>Ice Scoops</b>			
606106 $\Delta$	6 oz Stainless Steel Bar Scoop	—	24 ea
4306 $\Delta$ $\blacklozenge$	6 oz Polycarbonate Scoop	07	12 ea

NSF Listed products are designated with a  $\Delta$  and may be prefixed with an N

$\blacklozenge$  California Residents: Di(2-ethylhexyl)phthalate (DEHP) **WARNING:** See appendix B on w 1



# BAR ACCESSORIES

## Cocktail Shaker

- Bar Essential 18-8 mirror polished all stainless steel classic 3-piece shaker (608600) has a vented pour spout that reduces splashing and spills
- Units fit together snugly for no-mess shaking



608600

## Wine Servers & Coolers

### Double Walled Wine Coolers

- Double walled construction keeps bottles chilled for hours (no need to pre-chill cooler or use ice)
- Prevents damaging surface condensation
- 18-8 stainless steel is more durable than marble coolers; never requires polishing
- Choose satin or mirror polish finish
- 609144 and 609145 also accommodate champagne bottles
- Hand wash only



609143

## Wine Buckets & Stands

- Wine buckets and stands enhance any fine dining experience
- Choice of standard or double size wine bucket
- Stands are 24" high with heavy, weighted bases to prevent accidental tipping
- 18-8 stainless steel never requires polishing
- Mirror polish finish, hand wash only



609107



609107

609146

Prod No	Description	Pack
<b>Cocktail Shakers</b>		
608600	30 oz Classic Cocktail Shaker	12 ea
<b>Double Walled Wine Servers &amp; Coolers</b>		
609143	Double Wall Wine Cooler, Satin Finish with Mirror Finish Rim; 7.75" H	1 ea
<b>Wine Buckets &amp; Stands</b>		
609107	Wine Bucket (fits 609146)	4 ea
609146	24" Wine Bucket Stand, 7.5" Dia	1 ea

## Wine Server

- Wine Servers merchandise your wine selection
- Double-wall construction provides insulation to help keep wine at proper temperatures



## Red Wine Holder

- Satin finish 18-8 stainless steel never requires polishing
- Two rings orbit above the base to create an easy carry handle; bottles snap into handle for secure pouring
- Hand wash only



## Ice Buckets

- 18-8 stainless steel never requires polishing
- Double walled construction (609190, 609193) holds ice longer and prevents surface condensation
- 609190 has flat handle, hinged lid and comes complete with perforated drain tray and tong
- 609191 has mirror polished finish outside, satin finish inside, with knob handles
- 609193 has tubular handle and satin finish; complete with lid
- Hand wash only



Black(03)

Prod No	Description	Color	Pack
<b>Acrylic Wine Servers</b>			
IG224	Acrylic Server with Black Base	03	12 ea
<b>Red Wine Holder</b>			
609106	Red Wine Holder	—	1 ea
<b>Stainless Steel Ice Buckets</b>			
609190	1.5 qt Double Wall Ice Bucket with Tong	—	1 ea
609193	3.5 qt Double Wall Ice Bucket	—	1 ea
609191	1.7 qt Ice Bucket with Handle and Tong	—	1 ea



**CARLISLE**  
FOODSERVICE PRODUCTS

PRACTICAL  
ELEGANT  
RUGGED  
DURABLE  
**FOODSERVICE  
TRAYS**

---

*Carlisle trays and accessories are designed to please your patrons and enable your staff to serve meals economically without sacrificing durability. We set the standard for size, color selection, appearance and reliability.*





# FIBERGLASS TRAYS

## Glasteel™ Trays

Glasteel trays offer durability and cleanability at an affordable price.

- Engineered to be the most durable fiberglass trays available
- Decorating options, see page 334 for additional information
- 5-year limited warranty
- NSF Listed; dishwasher safe

### Heavy-Duty Construction

- Metal reinforcing rods provide extra strength and eliminate warping
- Two thick, reinforcing fiberglass core mats add strength and provide increased chemical resistance

### Air Flow Corner Reinforcements

- Air flow corner reinforcements and stacking lugs make Glasteel trays your best choice for stability and drying when stacked
- Unique design permits air flow to all surfaces of stacked trays, reducing drying time

Fiberglass Trays are available in full cases only.

There is a NO-RETURN POLICY on Customized Fiberglass Trays.



### Custom Decorating

Carlisle offers a decorating program so you can label your trays with a logo, image or any graphic visit [www.carlislefsp.com/custom-imprinting](http://www.carlislefsp.com/custom-imprinting) for more information



## Trapezoid

Space saving shape for better table fit



## Image Wrap

Full color images printed on both sides of the tray\*



## Rectangular Regular & Low-Edge

Low-edge trays have “squared-off” corners to permit dish overhang, fitting more serving items on a given tray size

## Display/Bakery

Ideal for displays and available in all colors and patterns



\*Contact Customer Service at 1-800-654-8210 for more information





Available for immediate shipment in  
Bone White(001), Natural(003),  
Black(004) and Almond(095)

See pages 152-155 for available  
tray sizes and colors

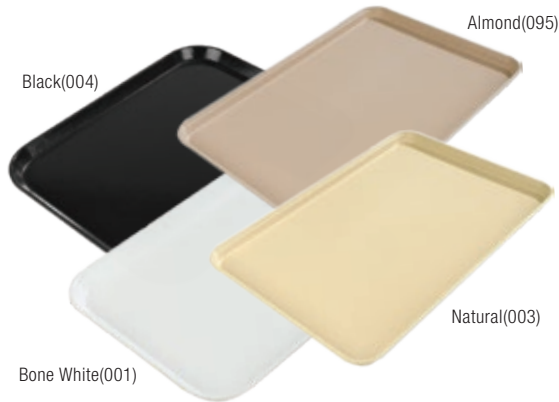

**Dimensions & Weights For Use With  
Self-Leveling Dispensers**

Prod No	Length	Width	Height of One	Height of 11	Weight of 10
1410FG	13-3/4"	10-5/8"	3/4"	3-5/16"	9lb 2oz
1612FG	16-3/8"	12"	3/4"	3-5/16"	11lb 12oz
1814FG	18"	14"	3/4"	3-1/2"	14lb 4oz
2015FG	20-1/4"	15"	3/4"	3-5/16"	17lb
2216FG	22"	16"	1-1/8"	4-1/8"	21lb 8oz
1713FG	18"	14"	3/4"	3-1/2"	14lb 12oz
2214FG	22"	14"	3/4"	3-5/16"	15lb 2oz

**BOX INDICATES ITEM IS AVAILABLE FOR IMMEDIATE SHIPMENT IN OUR MOST POPULAR SIZES**

**Trapezoid Tray Table Planner**

	1713	2214
36" Square Table Holds	4 ea	4 ea
42" Round Table Holds	4 ea	4 ea
54" Square Table Holds	6 ea	6 ea

Prod No	Description	Pack
<b>Solid Color</b>	<b>Decorative Pattern</b>	<b>Wood Grain</b>
<b>Rectangular</b>		
1410FG <span style="border: 1px solid black; border-radius: 50%; padding: 2px;">Δ</span>	1410DFG <span style="border: 1px solid black; border-radius: 50%; padding: 2px;">Δ</span>	1410WFG <span style="border: 1px solid black; border-radius: 50%; padding: 2px;">Δ</span>
1612FG <span style="border: 1px solid black; border-radius: 50%; padding: 2px;">Δ</span>	1612DFG <span style="border: 1px solid black; border-radius: 50%; padding: 2px;">Δ</span>	1612WFG <span style="border: 1px solid black; border-radius: 50%; padding: 2px;">Δ</span>
1814FG <span style="border: 1px solid black; border-radius: 50%; padding: 2px;">Δ</span>	1814DFG <span style="border: 1px solid black; border-radius: 50%; padding: 2px;">Δ</span>	1814WFG <span style="border: 1px solid black; border-radius: 50%; padding: 2px;">Δ</span>
2015FG <span style="border: 1px solid black; border-radius: 50%; padding: 2px;">Δ</span>	2015DFG <span style="border: 1px solid black; border-radius: 50%; padding: 2px;">Δ</span>	2015WFG <span style="border: 1px solid black; border-radius: 50%; padding: 2px;">Δ</span>
2216FGQ <span style="border: 1px solid black; border-radius: 50%; padding: 2px;">Δ</span>	—	2216WFGQ <span style="border: 1px solid black; border-radius: 50%; padding: 2px;">Δ</span>
<b>Low Edge</b>		
1216LFG <span style="border: 1px solid black; border-radius: 50%; padding: 2px;">Δ</span>	1216LDFG <span style="border: 1px solid black; border-radius: 50%; padding: 2px;">Δ</span>	1216LWFG <span style="border: 1px solid black; border-radius: 50%; padding: 2px;">Δ</span>
1418LFG <span style="border: 1px solid black; border-radius: 50%; padding: 2px;">Δ</span>	1418LDFG <span style="border: 1px solid black; border-radius: 50%; padding: 2px;">Δ</span>	—
1219LFG <span style="border: 1px solid black; border-radius: 50%; padding: 2px;">Δ</span>	1219LDFG <span style="border: 1px solid black; border-radius: 50%; padding: 2px;">Δ</span>	1219LWFG <span style="border: 1px solid black; border-radius: 50%; padding: 2px;">Δ</span>
1520LFG <span style="border: 1px solid black; border-radius: 50%; padding: 2px;">Δ</span>	1520LDFG <span style="border: 1px solid black; border-radius: 50%; padding: 2px;">Δ</span>	1520LWFG* <span style="border: 1px solid black; border-radius: 50%; padding: 2px;">Δ</span>
1222LFG <span style="border: 1px solid black; border-radius: 50%; padding: 2px;">Δ</span>	1222LDFG <span style="border: 1px solid black; border-radius: 50%; padding: 2px;">Δ</span>	1222LWFG <span style="border: 1px solid black; border-radius: 50%; padding: 2px;">Δ</span>
<b>Display/Bakery</b>		
269FG <span style="border: 1px solid black; border-radius: 50%; padding: 2px;">Δ</span>	269DFG <span style="border: 1px solid black; border-radius: 50%; padding: 2px;">Δ</span>	269WFG <span style="border: 1px solid black; border-radius: 50%; padding: 2px;">Δ</span>
1318FG <span style="border: 1px solid black; border-radius: 50%; padding: 2px;">Δ</span>	1318DFG <span style="border: 1px solid black; border-radius: 50%; padding: 2px;">Δ</span>	—
2618FGQ <span style="border: 1px solid black; border-radius: 50%; padding: 2px;">Δ</span>	2618DFGQ <span style="border: 1px solid black; border-radius: 50%; padding: 2px;">Δ</span>	2618WFGQ <span style="border: 1px solid black; border-radius: 50%; padding: 2px;">Δ</span>
<b>Trapezoid</b>		
1713FG <span style="border: 1px solid black; border-radius: 50%; padding: 2px;">Δ</span>	1713DFG <span style="border: 1px solid black; border-radius: 50%; padding: 2px;">Δ</span>	1713WFG <span style="border: 1px solid black; border-radius: 50%; padding: 2px;">Δ</span>
2214FG <span style="border: 1px solid black; border-radius: 50%; padding: 2px;">Δ</span>	2214DFG <span style="border: 1px solid black; border-radius: 50%; padding: 2px;">Δ</span>	2214WFG <span style="border: 1px solid black; border-radius: 50%; padding: 2px;">Δ</span>
<b>Metric</b>		
2310FG <span style="border: 1px solid black; border-radius: 50%; padding: 2px;">Δ</span>	2310DFG <span style="border: 1px solid black; border-radius: 50%; padding: 2px;">Δ</span>	2310WFG <span style="border: 1px solid black; border-radius: 50%; padding: 2px;">Δ</span>
1220FG <span style="border: 1px solid black; border-radius: 50%; padding: 2px;">Δ</span>	1220DFG <span style="border: 1px solid black; border-radius: 50%; padding: 2px;">Δ</span>	1220WFG <span style="border: 1px solid black; border-radius: 50%; padding: 2px;">Δ</span>
1212FG <span style="border: 1px solid black; border-radius: 50%; padding: 2px;">Δ</span>	—	1212WFG <span style="border: 1px solid black; border-radius: 50%; padding: 2px;">Δ</span>
2115FG <span style="border: 1px solid black; border-radius: 50%; padding: 2px;">Δ</span>	2115DFG <span style="border: 1px solid black; border-radius: 50%; padding: 2px;">Δ</span>	2115WFG <span style="border: 1px solid black; border-radius: 50%; padding: 2px;">Δ</span>
1419FG <span style="border: 1px solid black; border-radius: 50%; padding: 2px;">Δ</span>	1419DFG <span style="border: 1px solid black; border-radius: 50%; padding: 2px;">Δ</span>	1419WFG <span style="border: 1px solid black; border-radius: 50%; padding: 2px;">Δ</span>

NSF Listed products are designated with a Δ and may be prefixed with an N  
See corresponding covers on page 160



# GLASTEEL™ TRAY COLOR SAMPLES

BOX INDICATES ITEM IS AVAILABLE FOR IMMEDIATE SHIPMENT IN OUR MOST POPULAR SIZES

## Solid Colors

**001**

**Bone White**

1410FG	1222LFG*
1612FG	269FG*
1814FG	1318FG*
2015FG	2618FGQ
2216FGQ*	1713FG
1216LFG*	2214FG*
1418LFG*	1220FG*
1219LFG*	2115FG*
1520LFG*	

**003**

**Natural**

1410FG	2216FGQ
1612FG	269FG*
1814FG	2618FGQ
2015FG	1713FG

**004**

**Black**

1410FG	1222LFG*
1612FG	269FG*
1814FG	1318FG*
2015FG	2618FGQ
2216FGQ*	1713FG
1216LFG*	2214FG*
1418LFG*	1220FG*
1219LFG*	1212FG*
1520LFG*	

**095**

**Almond**

1612FG	2618FGQ
1814FG	1713FG
2015FG	

**002**

**Smoke Gray**

1410FG*	1520LFG*
1612FG*	269FG*
1814FG*	1318FG*
2015FG*	2618FGQ*
2216FGQ*	1713FG*
1418LFG*	1220FG*
1219LFG*	

**005**

**Pewter**

2216FGQ*	2618FGQ*
1520LFG*	2214FG*

**006**

**Ultramarine**

1410FG*	1219LFG*
2015FG*	1713FG*

**007**

**Tropical Green**

1814FG*	2216FGQ*
2015FG*	2618FGQ*

**008**

**Avocado**

2216FGQ*	1220FG*
1713FG*	

**009**

**Lime**

1410FG*	269FG*
1612FG*	1318FG*
1814FG*	2618FGQ*
2015FG*	1713FG*
2216FGQ*	2214FG*
1216LFG*	

**010**

**Forest Green**

1410FG*	1219LFG*
1814FG	1318FG*
2015FG*	2618FGQ*
2216FGQ	2214FG*

**011**

**Turquoise**

1410FG*	1219LFG*
1814FG	1318FG*
2015FG*	2618FGQ*
2216FGQ	2214FG*

\* Color available by special order only



Ice Blue

1612FG*	1520LFG*
1814FG*	2618FGQ*
2015FG*	1212FG*
2216FGQ*	



Cobalt Blue

1410FG*	269FG*
1612FG*	1318FG*
1814FG*	2618FGQ*
2015FG*	1713FG*
2216FGQ*	



Navy

1612FG*	1216LFG*
1814FG*	1418LFG*
2015FG*	2618FGQ*
2216FGQ*	1220FG*



Peach

2216FGQ*	1220FG*
2618FGQ*	



Red

1410FG*	1418LFG*
1612FG*	269FG*
1814FG	1318FG*
2015FG*	2618FGQ*
2216FGQ*	2214FG*
1216LFG*	



Orange

1410FG*	269FG*
1814FG*	2618FGQ*
1520LFG*	1713FG*



Rust

1612FG*	2216FGQ*
1814FG*	



Coral

1612FG*	1713FG*
1814FG*	2214FG*
2618FGQ*	



Pineapple

2618FGQ*	2214FG*
1713FG*	



Ivory

1612FG*	1520LFG*
1814FG*	269FG*
2216FGQ*	2618FGQ*
	1220FG*



Gold

1410FG*	2216FGQ*
1814FG*	269FG*
2015FG*	2618FGQ*
	1713FG

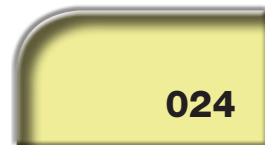

Lemon

2216FGQ*	2618FGQ*
----------	----------

\* Color available by special order only



# GLASTEEL™ TRAY COLOR SAMPLES

## Solid Colors



025

Beige

- 1410FG\*
- 1814FG\*
- 2015FG\*
- 2216FGQ\*
- 1418LFG\*

- 1219LFG\*
- 2618FGQ\*
- 1713FG\*
- 1220FG\*



050

Sapphire

- 1410FG\*
- 1814FG\*
- 2015FG\*
- 2216FGQ\*
- 1216LFG\*

- 1418LFG\*
- 2618FGQ\*
- 1713FG\*
- 2214FG\*



051

Teal

- 1410FG\*
- 2216FGQ
- 1520LFG\*

- 2618FGQ\*
- 2214FG\*



052

Amethyst

- 2216FGQ\*

- 1220FG\*



053

Jade

- 1814FG\*

- 2618FGQ\*
- 1220FG\*



054

Mulberry

- 1410FG\*

- 1612FG\*
- 1814FG\*
- 2216FGQ\*



055

Rainforest Green

- 1814FG\*

- 2015FG\*



066

Mauve

- 1410FG\*
- 1814FG\*
- 2015FG\*
- 2216FGQ\*

- 1520LFG\*
- 269FG\*
- 2618FGQ\*
- 1713FG\*



067

Slate Blue

- 1410FG\*
- 1814FG\*
- 1713FG\*

- 2214FG\*
- 1419FG\*



068

Gray

- 1612FG\*
- 1814FG
- 2015FG
- 2216FGQ

- 1222LFG\*
- 2618FGQ\*
- 1713FG\*



069

Raspberry

- 1814FG\*
- 2015FG\*

- 2618FGQ\*
- 1713FG\*



076

Coffee Tan

- 1814FG\*
- 2216FGQ\*

- 2618FGQ\*
- 1713FG\*

\* Color available by special order only



Chocolate

- 1410FG\*
- 1612FG\*
- 1814FG\*
- 2015FG\*
- 2216FGQ\*
- 1520LFG\*
- 269FG\*
- 1318FG\*
- 2618FGQ\*
- 1713FG\*
- 2214FG\*



Pacific Blue

- 1612FG\*
- 1814FG\*
- 1220FG\*



Bay Leaf Brown

- 1814FG\*
- 2015FG\*



Cherry Red

- 1612FG\*
- 2015FG\*
- 2216FGQ\*

### Decorative Patterns



Starfire Gray

- 1814DFG\*
- 1216LDFG\*



Starfire Blue

- 1410DFG\*
- 1418LDFG\*



Starfire Natural

- 1814DFG\*
- 2015DFG\*
- 1418LDFG\*
- 1713DFG\*

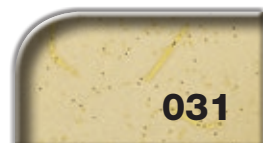

Starfire Beige

- 1418LDFG\*

### Wood Grain Patterns



Pecan

- 1814WFG\*
- 2015WFG\*
- 1216LWFG\*
- 269WFG\*



Light Oak

- 1520LWFG
- 269WFG\*
- 1220WFG\*



Butcher Block

- 1410WFG\*
- 1814WFG\*
- 1216LWFG\*
- 1713WFG\*



Redwood

- 1814WFG\*
- 1713WFG\*



# SPECIALTY TRAYS

Carlisle offers a **broad assortment** of shapes and colors to ensure all your tray needs are met.

## Fiberglass Market Trays & Pans

- Use for displaying breads, bakery items and sliced deli meat
- 2" deep pans for serving deli salads, pasta and desserts
- Trays have heavy-duty fiberglass construction and metal reinforced rods
- Air-flow corners reduce drying time
- NSF Listed



**BOX INDICATES ITEM IS AVAILABLE FOR IMMEDIATE SHIPMENT IN OUR MOST POPULAR SIZES**



Prod No	Description	Color	Pack
<b>Fiberglass Market Trays</b>			
630FMT <span style="color: orange;">▲</span>	30.00/6.44/0.75	309*	12 ea
830FMT <span style="color: orange;">▲</span>	30.00/8.50/0.75 Tray	301, 309	12 ea
1030FMT <span style="color: orange;">▲</span>	30.00/10.44/0.75 Tray	301, 309	12 ea
1230FMT <span style="color: orange;">▲</span>	30.00/12.44/1.05 Tray	301, 309	12 ea
269FMT <span style="color: orange;">▲</span>	8.75/25.50/1.12 Tray	301, 309	12 ea
1218FMT <span style="color: orange;">▲</span>	17.75/11.44/0.75 Tray	301, 309	12 ea
1318FMT <span style="color: orange;">▲</span>	17.75/12.75/1.00 Tray	301, 309	12 ea
2618FMTQ <span style="color: orange;">▲</span>	17.87/25.62/1.25 Tray	301, 302, 303, 304, 306, 309	6 ea
<b>Fiberglass Market Pans</b>			
6302FMT <span style="color: orange;">▲</span>	30.00/6.45/2.00 Pan	301, 309	12 ea
8302FMT <span style="color: orange;">▲</span>	30.00/8.45/2.00 Pan	301, 309	12 ea
10302FMT <span style="color: orange;">▲</span>	30.00/10.47/2.00 Pan	301, 309	12 ea

NSF Listed products are designated with a ▲ and may be prefixed with an N



## Café Trays

- Feature skid-resistant surface and drying/stacking lugs
- Custom hot stamping is available, see page 334 for additional information
- Economical & light-weight polypropylene
- NSF Listed



CT1014

CT1216

## Standard Café Tray

- Traditional scratch-resistant basket weave design reduces slipping and helps prevent accidental spills

## Trapezoid Café Tray

- Space saving shape allows diners to eat directly from trays without removing plates, cups, etc. from the tray
- Promotes self-bussing

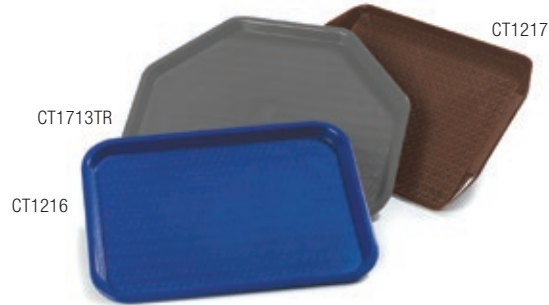

CT1217

CT1713TR

CT1216

Carlisle recommends hand washing for Café Trays

## Handled Café Tray

- Handled tray is easy to carry and offers added strength

## Bistro™ Trays

- Unique trays offer a great look at an economical price
- Durability and economy of our Café Trays with stylish curved handles for easy handling and added strength
- Scratch-resistant, textured design reduces slipping, helps prevent spills
- Drying and stacking lugs



1217BT

1319BT

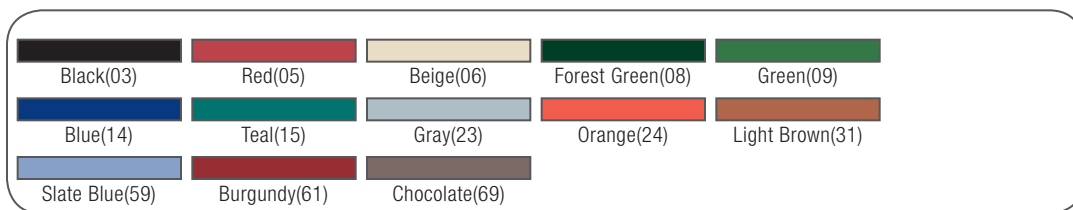

Prod No	Description	Color	Pack
<b>Café Trays</b>			
CT1014 $\Delta$	13.87/10.75/0.79 Standard Tray	03, 05, 06, 08, 09, 14, 15, 23, 24, 61, 69	24 ea
CT1216 $\Delta$	16.31/12.06/0.70 Standard Tray	03, 05, 06, 08, 09, 14, 15, 23, 24, 31, 59, 61, 69	24 ea
CT1418 $\Delta$	17.87/14.00/0.98 Standard Tray	03, 05, 06, 08, 09, 14, 15, 23, 24, 31, 59, 61, 69	12 ea
CT1713TR $\Delta$	18.00/14.00/0.81 Trapezoid Tray	03, 06, 14, 23, 69	12 ea
CT1217 $\Delta$	16.93/12.06/0.60 Handled Tray	03, 05, 14, 69	24 ea
<b>Bistro Trays</b>			
1217BT	12" x 17" Bistro Tray	03	12 ea
1319BT	13" x 19" Bistro Tray	03	12 ea

NSF Listed products are designated with a  $\Delta$  and may be prefixed with an N



# COMPARTMENT TRAYS

Our Compartment Trays are the perfect **cost effective solution** for portion control.

## 6-Compartment Trays

- The 6-compartment trays hold government "Type A" lunch
- Carlisle offers the largest variety of sizes and compartment combinations available
- All materials are FDA approved and NSF Listed



## Materials

### Melamine

- Melamine is a heavy, rigid material with the look and feel of china
- It is very scratch- and break-resistant
- Fast drying melamine is highly resistant to chemicals and food acids with a temperature range of 0° to 212°F

### Polycarbonate

- Money saving trays carry a five-year warranty against breakage
- Highly break-resistant; perfect choice for correctional facilities
- Polycarbonate offers good scratch- and chemical-resistance with a temperature range of -40° to 212°F

### Polypropylene

- Economical, durable choice
- Good chemical resistance
- Temperature range of 30° to 180°F
- Handwashing is recommended

### ABS

- Break- & scratch-resistant
- Excellent choice for general use
- Highly resistant to chemicals and food acids with a temperature range of 0° to 180°F

## Orientations

### Left & Right-Hand

- Offer a greater variety of serving combinations
- Available in melamine, polycarbonate, ABS and polypropylene
- NSF Listed, except when offered in Variegated(00)

### Omni-Directional & Space Saver Trays

- Special design allows you to fit two trays side by side in dish rack for faster cycling time





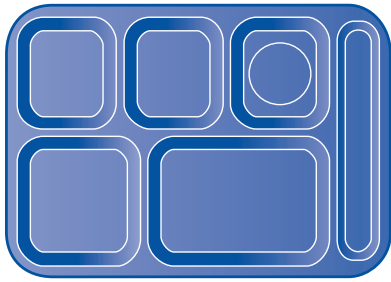

**Right-Hand Tray**  
(43988, 43989, 614R, P614R)

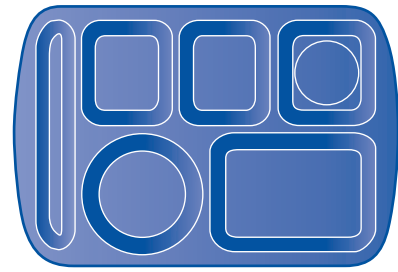

**Handled Economy Left-Hand Tray**  
(5865)

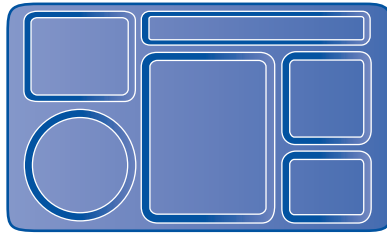

**Space-Saver Omni-Directional Tray**  
(615\*\*)

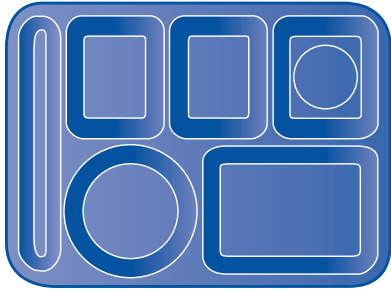

**Left-Hand Tray**  
(43980, 43981, 614, P614, 614PC†)

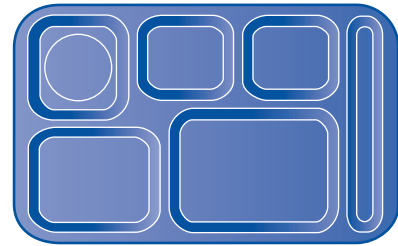

**Space-Saver Right-Hand Tray**  
(43982, 43983)

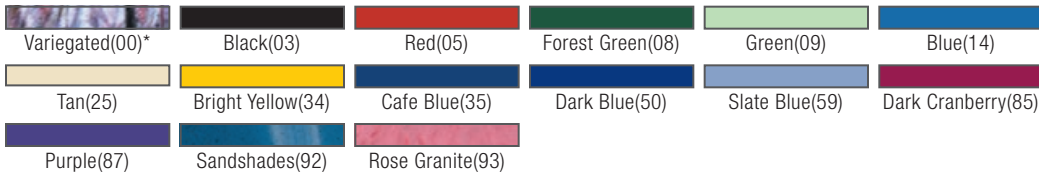

Prod No	Description	Color	Pack
<b>Right-Hand Trays</b>			
43988 Δ	Heavy-weight Melamine Tray	05, 08, 25, 34, 35, 50, 59, 85, 87	12 ea
43989 Δ	Heavy-weight Sandshades/ Rose Granite Melamine	00*, 92	12 ea
614R	ABS Tray	03, 05, 09, 25, 59	24 ea
P614R	Polypropylene Tray	05, 09, 14, 25	24 ea
<b>Space-Saver Right-Hand Tray</b>			
43982 Δ	Space-Saver Melamine Tray	05, 08, 50, 59	12 ea
43983 Δ	Space-Saver Sandshades Melamine Tray	92	12 ea
<b>Left-Hand Trays</b>			
43980 Δ	Heavy-weight Melamine Tray	05, 08, 25, 35, 50, 59, 85, 87	12 ea
43981 Δ	Heavy-weight Sandshades/Rose Granite Melamine	00*, 92, 93	12 ea
614PC † ♦	Polycarbonate Tray	25	24 ea
614	ABS Tray	03	24 ea
P614	Polypropylene Tray	05, 25	24 ea
<b>Handled Economy Melamine Left-Hand Tray</b>			
5865	Handled Economy Melamine Tray, Variegated	00*	12 ea
<b>Space-Saver Omni-Directional Tray</b>			
615**	Space-Saver ABS Tray	03, 05, 14, 25	24 ea

NSF Listed products are designated with a Δ and may be prefixed with an N

\*Note: Variegated(00) option is not NSF Listed

\*\*615 is a licensed product under U.S. Patent D292,768

† 614PC carries a 5-year warranty against breakage

Rose Granite, Sandshades and Variegated items vary in color, hue and intensity from piece to piece

♦ California Residents: Bisphenol A **WARNING:** See appendix A on page 1



# TRAYS, COVERS & ACCESSORIES

## Polycarbonate Compartment Trays

### 5-Compartment Trays

- 5-year warranty against breakage
- Inside compartments have a textured surface for greater scratch resistance
- 5-year limited warranty
- NSF Listed; dishwasher safe

### 4-Compartment Trays

- Smaller size trays are perfect for elementary schools and lunch menus
- Omni-directional KL444 and 43986 trays feature two-way stacking
- 5-year limited warranty
- NSF Listed; dishwasher safe



### Compartment Tray Cover

- Help maintain food temperatures and protect food from contamination and spills
- Dishwasher safe

### Pastry Tray Covers

- Clear covers offer best visibility in bakeries, delis and convenience stores
- Sanitary covers help preserve taste and quality
- Rust-proof stainless steel hinges and screws provide long life
- Use with Carlisle trays, see pages 150-151 for corresponding trays

### Carlisle Tray Guide

SC25 & SC26 fit 2618FG, 2618DFG, 2618WFG trays

SC27 & SC29 fit 1220FG, 1220DFG, 1220WFG trays

SC40 fits 1318FG, 1318DFG, 1318WFG trays

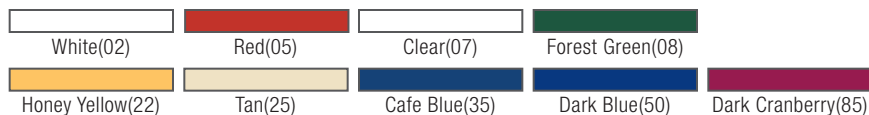

Prod No	Description	Color	Pack
<b>5-Compartment Trays</b>			
PCD801 <span style="color: yellow;">▲</span>	5-Compartment Tray, 11.50/10.50/1.00	25	24 ea
<b>4-Compartment Trays</b>			
43984 <span style="color: yellow;">▲</span>	4-Compartment Tray, Right-Hand, 10.11/9.79/0.51	05, 22, 50	48 ea
43986 <span style="color: yellow;">▲</span>	4-Compartment Server Tray, 10.30/9.58/0.85	25, 35	36 ea
KL444 <span style="color: yellow;">▲</span>	4-Compartment Tray, 10.95/8.67/0.62	08, 85	12 ea
<b>Compartment Tray Cover</b>			
10145	Cover Fits Non-Handled Right and Left Handed 6-Compartment Trays	02	12 ea
<b>Pastry Tray Covers</b>			
SC25	26" x 18" x 4" Cover	07	1 ea
SC26	26" x 18" x 4" Hinged Cover	07	1 ea
SC27	20" x 12" x 4" Cover	07	3 ea
SC29	20" x 12" x 4" Hinged Cover	07	3 ea
SC40	18" x 13" x 4" Cover	07	1 ea

NSF Listed products are designated with a ▲ and may be prefixed with an N





### Room Service Trays

- 15" x 20" handled room service trays give an upscale dining experience
- Low rimmed edge and non-skid surface keep tray top items in place
- NSF Listed; dishwasher safe



RST1520NSQ

### Tip Trays

- Standard Tip Tray and Check Holder are made of styrene
- Check Holders handy clip keeps checks, credit cards or cash securely in place
- NSF Listed; dishwasher safe



### Money Maid™ Combo Packs

- Contains a locking coin and bill compartment, napkin holder and utility pocket; designed to clip onto trays; see our line of Griptite2, GripLite and Cork Trays shown on pages 162-163
- Combo Packs include one Money Maid and six coin trays in a shrink-wrapped set
- Round Clip-On (1401) fits all standard 14" round trays
- Rectangular Clip-On (1030) and Coin Trays fit all 12" x 16" trays



Prod No	Description	Color	Pack
<b>Foodservice Room Service Trays</b>			
RST1520NSQ Δ	15" x 20" Low Profile Room Service Tray	03	6 ea
<b>Tip Trays</b>			
3022 Δ ♦	Standard Tip Tray; 4.5" x 6.5"	01, 03	36 ea
3020 Δ ♦	Check Holder Tip Tray; 4.38" x 7.75"	03	12 ea
<b>Money Maid Combo Packs</b>			
1401	Round Clip-On Money Maid	01	12 ea
1031	Round Money Maid Combo Pack with Six Coin Trays	01	12 ea
1030	Rectangular Money Maid Combo Pack with Six Coin Trays	01	12 ea

NSF Listed products are designated with a Δ and may be prefixed with an N  
 ♦ California Residents: Styrene **WARNING:** See appendix C on page 1



# SERVICE TRAYS

## Griptite™ 2

- A service tray built for the real world
- Griptite 2 trays non-skid surface is designed to grip drinks and plates better than any existing tray
- The new surface prevents spills and is designed to look and feel like new for years
- Increased skid resistance of our GT2 surface helps bars and restaurants reduce falls and lower the cost of spilled food and drinks
- Additional coating on sides of tray reduces wear and tear due to drops
- Improved stain resistance keeps trays looking new longer
- Heavy-duty fiberglass construction eliminates warping and breakage
- Trays are stain and odor resistant
- 5-year limited warranty
- NSF Listed; dishwasher safe



1600GR2



1600GR2

2700GR2

1400GR2



Prod No	Description	Color	Pack
<b>Griptite 2 Trays</b>			
1100GR2 <span style="color: yellow;">▲</span>	Griptite 2 Round Tray 11.75"	004, 076	12 ea
1400GR2 <span style="color: yellow;">▲</span>	Griptite 2 Round Tray 14.75"	004, 076	12 ea
1600GR2 <span style="color: yellow;">▲</span>	Griptite 2 Round Tray 16"	004, 076	12 ea
1814GR2 <span style="color: yellow;">▲</span>	Griptite 2 Rectangular Tray 18" x 14.88"	004, 076	12 ea
1826GR2Q <span style="color: yellow;">▲</span>	Griptite 2 Rectangular Tray 18" x 25.75"	004, 076	6 ea
2015GR2 <span style="color: yellow;">▲</span>	Griptite 2 Rectangular Tray 20.25" x 15"	004, 076	12 ea
2216GR2Q <span style="color: yellow;">▲</span>	Griptite 2 Rectangular Tray 22" x 16"	004, 076	6 ea
2500GR2 <span style="color: yellow;">▲</span>	Griptite 2 Oval Tray 24" x 19.25"	004, 076	6 ea
2700GR2 <span style="color: yellow;">▲</span>	Griptite 2 Oval Tray 27" x 22.31"	004, 076	6 ea
3100GR2 <span style="color: yellow;">▲</span>	Griptite 2 Oval Tray 31.5" x 23.5"	004, 076	6 ea
3253GR2 <span style="color: yellow;">▲</span>	Griptite 2 Rectangular Tray 12.75" x 20.88"	004	12 ea

NSF Listed products are designated with a ▲ and may be prefixed with an N



## GripLite® Polypropylene

- Economical alternative
- Made of a high density polypropylene co-polymer
- Molded-in, rubber liner prevents slipping and sliding of glasses and dinnerware
- A more sanitary alternative to cork trays
- Stain and odor resistant
- Handwashing is recommended



## Cork Trays

- Durable plastic construction will not chip or dent
- Available in economical, lightweight, break-resistant polypropylene for bar service or break-resistant, sturdy ABS for heavy-duty use and greater stability
- The cork surface is bonded to the tray and treated to reduce wear and increase durability
- Replacement cork available at [www.carlislefsp.com/replacement-parts](http://www.carlislefsp.com/replacement-parts)
- Handwashing is recommended



Prod No	Description	Color	Pack
<b>GripLite Trays</b>			
1100GL	11.25/0.76 Round Tray	004, 076	12 ea
1400GL	14.63/0.76 Round Tray	004, 076	12 ea
1600GL	16.44/0.73 Round Tray	004, 076	12 ea
<b>Cork Trays</b>			
3014	14.00/0.75 Round Tray	01	12 ea
3016	16.00/0.75 Round Tray	01	12 ea
2419	24.00/19.00/0.75 Oval Tray	01	6 ea
2823	28.00/23.00/0.75 Oval Tray	01	6 ea

NSF Listed products are designated with a  $\Delta$  and may be prefixed with an N

# SERVING TRAYS & STANDS

## Celebration Trays

- Large trays are perfect for serving bread, cheeses, hors d'oeuvres and pastries
- Economically priced trays are perfect for off site catering or buffet displays
- Sturdy and reusable, they are the perfect alternative to disposables
- Chrome-plated, mirror-polished finish never requires polishing
- Hand wash only; polish dry with soft cloth

### Round



### Oval



### Rectangular



### Octagonal



Prod No	Description	Pack
<b>Celebration Trays</b>		
608905	13" Round Gadroon Tray	12 ea
608907	14" Round Gadroon Tray	12 ea
608919	20.88" x 13.5" Oval Tray with Integral Handles	12 ea
608904	17.75" x 12.88" Oval Tray with Ornate Border	12 ea
608913	17.75" x 12.88" Oval Tray with Gold Border	12 ea
608918	21" x 15" Rectangular Tray with Ornate Border	12 ea
608908	18.25" x 12.38" Rectangular Tray with Gold Border	12 ea
608909	20.63" x 14" Rectangular Tray with Gold Border	12 ea
608901	17.13" x 11.75" Octagonal Tray with Beaded Border	12 ea
608902	20" x 13.75" Octagonal Tray with Beaded Border	12 ea



## Festival Trays™

- Beautiful alternative to glass, crystal, or disposables
- Use durable trays for catering, parties, weddings, conventions, cruise lines or poolside service
- Molded-in pattern gives the appearance of fine etched crystal
- Economical, break-resistant SAN resists food acids and oils
- Lowers replacement costs
- Safe in temperatures from 0° to 180°F
- Dishwasher safe



## Tray Stands

- Cross supports provide superior rigidity and strength
- Durable and easy to clean
- Available in 3 forms: Steel, Wood & Plastic
- Capped legs on steel tray stands prevent slipping and marring of floors
- Extra tall steel tray stand (C3625T) reduces need for bending and stooping; additional height makes transferring heavy loads easier
- Plastic stands have sanitary, non-porous and non-corrosive finish that is easy to clean with a damp cloth

Works great with Griptite 2, GripLite and Cork Trays

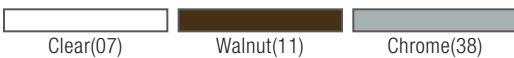

Prod No	Description	Color	Pack
<b>Festival Trays</b>			
6413	13" Round Tray	07	12 ea
6416	16" Round Tray	07	12 ea
6417	12.5" x 7" Rectangular Tray	07	12 ea
6450	15" x 10.75" Rectangular Tray	07	12 ea
6426	22" x 16" Handled Tray	07	6 ea
6439	13" x 19.5" Handled Tray	07	6 ea
<b>Tray Stands</b>			
C3625T	36" Tall Steel Stand	38	6 ea
C3620W	30" Wood Stand	11	6 ea
C3630W	30.5" Plastic Stand	11	6 ea



**CARLISLE**  
FOODSERVICE PRODUCTS

CARLISLE





# RUGGED BEAUTIFUL PORTABLE CONVENIENT **CATERING EQUIPMENT**

---

*Carlisle's catering equipment line is the professional's choice for your insulated transport needs. Only Carlisle Cateraide's can offer attractive contemporary styling, longer hold times and unique battle tested features that provide you superior value.*





# Choose The CATERAIDE™ To Best Fit Your Needs.

All CATERAIDES are NSF Listed and made of rugged, stain- and scratch-resistant polyethylene.

## Good

LD, XT and PC Series pan carriers withstand the wear and tear of high volume catering and insulate for 4-6 hours. PC Series CATERAIDES are our workhorse product and include both end loaders and top loaders that can be used for hot or cold food. PC top loaders feature automatic self-venting system, preventing unsanitary vent openings and lost vent caps. LD and XT beverage carriers feature a faucet 4" from the base to ensure space for cups or glasses and include the Nylex II™ latch mounted into steel reinforcement plates for extended life. XT beverage carriers stack with standard CATERAIDES or other major competitors.



# LD, XT & PC Series



## Better

Carlisle's patented\* Slide 'N Seal™ design is combined with Carlisle's thick insulation to hold temperatures for 4 to 6 hours. Slide 'N Seal carriers have self-venting, sliding doors and lids. There are no metal parts, latches, hinges or gaskets to clean, break or wear out. A beverage server is also offered in our Slide 'N Seal line. Our patented unique lid seal provides leak-proof transport. These items have a sleek, contemporary appearance. The ergonomical design them easy to load, handle, stack and store. Items include a molded-in tag slot to seal and tag carrier for safety and food identification.

\*Slide 'N Seal Pan Carrier Patent No. 7,134,552



# Slide 'N Seal





## Best

IT Cateraides are manufactured to provide superior food quality and safety. Designed for the professional, Cateraide IT features commercial foam insulation, reinforced corner and one-handed adjustable latches. The detailed design continues with recessed hinges that stay out of the way and are less likely to catch and break. Transporting is easier with multiple comfort-grip handles and secure stacking of units. Let Cateraide IT keep your food safe and secure.



# IT Series





# CATERAIDE™ IT

Introducing the **newly designed** Cateraide IT insulated transport line of products. IT is the only choice for foodservice professionals who demand they have it all. For the first time, rugged durability and industry leading safe food holding times are combined with **attractive, contemporary styling**. Cateraide IT sets a **new standard for value**.

## Insulated Beverage Dispenser

- Heavy foam insulation holds temperatures in the safe zone for over 6 hours
- Field adjustable latches ensure a secure seal for the life of the carrier
- “Spring Action” faucet for no drip service
- Button-hole latch design offers convenient one hand operation and keeps the doors and lids closed tightly for better temperature retention
- Sure-grip handles promote a safe, stable, two-person lift for easy loading and unloading



IT500  
Easily identify contents using the integrated writing surface

Higher spigot position allows for larger cups and mugs to fit underneath with ease



Prod No	Description	Color	Pack
<b>Cateraide IT</b>			
IT250 Δ	2.5 gal Beverage Dispenser	03, 43	1 ea
IT500 Δ	5 gal Beverage Dispenser	03, 43	1 ea
IT1000 Δ	10 gal Beverage Dispenser	03, 43	1 ea

NSF Listed products are designated with a Δ and may be prefixed with an N  
Note: IT1000 can be shipped UPS/FedEx ground at oversize cost

## End & Top Loader

- Holds six 2-1/2" deep food pans
- Heavy foam insulation holds temperatures in the safe zone for over 6 hours
- Secure stacking for easy transport and storage
- Sure-grip handles promote a safe, stable, two-person lift for easy loading and unloading
- Exclusive, low-profile, double hinge opens 270° for easy loading and unloading; lies flat to save space and makes it less likely to break
- Field adjustable latches ensure a secure seal for the life of the carrier
- Door hinge can be removed for easy, thorough cleaning
- Built-in seal eliminates gaskets on end & top loaders
- Use with CaterCooler to help keep foods at ServeSafe® temps longer (shown on page 176)

ServeSafe® is a registered trademark of the National Restaurant Association



Flat top design can be used as a prep surface when space is limited



Button-hole latch design offers convenient one hand operation



Exclusive double hinge opens 270°



IT400



IT410

4 rotating wheels give this dolly unmatched maneuverability



IT140



Prod No	Description	Color	Pack
<b>Cateraide IT</b>			
IT400 Δ	End Loader (six pan capacity)	03, 43, 62*	1 ea
IT140 Δ	4" Top Loader (holds one full size pan up to 4" deep)	03, 43	1 ea
IT160 Δ	6" Top Loader (holds one full size pan up to 6" deep)	03, 43	1 ea
IT180 Δ	8" Top Loader (holds one full size pan up to 8" deep)	03, 43	1 ea
IT410 Δ	End Loader Dolly with Casters	03	1 ea

NSF Listed products are designated with a Δ and may be prefixed with an N

Note: IT180, IT400 can be shipped UPS/FedEx ground at oversize cos

\* Color available by special order only



# CATERAIDE™ SLIDE 'N SEAL

Only the Carlisle Slide 'N Seal offers **latch free construction** with no metal parts. Perfect for outdoor use in recreation and leisure markets, schools and correctional facilities.

## Insulated Beverage Dispenser

- Revolutionary Slide 'N Seal design is combined with Carlisle's thick insulation to hold temperatures longer
- Patented\* Slide 'N Seal design glides shut and closes tightly without latches
- No metal parts – ideal for correctional facilities
- The integrated seal keeps beverages hot or cold longer
- Sleek contemporary appearance; ergonomically designed for easy loading, handling, stacking and storing
- Tough, scratch-resistant polyethylene construction is easy to clean and maintain
- "Spring action" faucet for dripless service
- NSF Listed

\*Slide 'N Seal Patents Beverage Dispensers: Patent No. 7,328,816



XB5

Find replacement parts at [www.carlislefsp.com/replacement-parts](http://www.carlislefsp.com/replacement-parts)



Easy twist on/off lid for leak-proof transport



Molded-in handles for easy transport



Lock can be placed through molded-in tag hole for a secure, tamper-proof closure



Prod No	Description	Color	Pack
XB5 Δ	5 gal Slide 'N Seal Beverage Dispenser	01*, 03, 08*	1 ea

NSF Listed products are designated with a Δ and may be prefixed with an N

\* Color available by special order only

## Top & End Loaders

- Revolutionary Slide 'N Seal design is combined with Carlisle's thick insulation to hold temperatures longer
- Patented\* Slide 'N Seal lids and doors glide shut and stay closed without latches or gaskets
- No metal parts – ideal for correctional facilities
- The integrated seal keeps food hot or cold longer
- Self-venting lids and doors keep foods fresher, crisper and more appetizing
- Exclusive lid design has a molded-in tethered lock pin to seal carrier for safety
- End Loader has molded-in tag slot to seal and tag carrier for safety and food identification
- Sleek contemporary appearance; ergonomically designed for easy loading, handling, stacking and storing
- Tough, scratch-resistant polyethylene construction is easy to clean and maintain
- Use with CaterCooler to help keep foods at ServeSafe® temps longer (shown on page 176)
- NSF Listed

\*Slide 'N Seal Patents

Pan Carriers: Patent No. 7,134,552



Sliding doors easily open and close for quick access and transport

Find replacement parts at [www.carlislefsp.com/replacement-parts](http://www.carlislefsp.com/replacement-parts)



Prod No	Description	Color	Pack
<b>Slide 'N Seal Top Loaders</b>			
XT1400 Δ	4" Slide 'N Seal Top Loader	03	1 ea
XT1600 Δ	6" Slide 'N Seal Top Loader	01**, 03, 08**	1 ea
XT1800 Δ	8" Slide 'N Seal Top Loader	01**, 03	1 ea
<b>Slide 'N Seal End Loaders</b>			
XT3000R Δ	Slide 'N Seal End Loader	01*, 03	1 ea

NSF Listed products are designated with a Δ and may be prefixed with an N  
NOTE: XT1800, XT3000R can be shipped UPS/FedEx Ground at oversize cost

\*\* Color available by special order only



# CATERAIDE™ XT & LD

## XT Series Insulated Beverage Dispenser - *The Value Leader*

- Made of rugged, stain- and scratch-resistant polyethylene
- Filled with extra thick foam insulation for maximum temperature retention
- Stacks with itself and with other major competitors
- Smooth interior walls and rounded corners leave no food traps and provides quick clean-up
- Convex lid design prevents leaks during use as pressure increases
- Modern XT lid design with convenient pop-up vent
- Improved O-ring seal eliminates leaks during transport
- Easy-grip, formed handles for transporting
- Sure-Latch™ wide design has three times the latch area of other beverage servers for a secure seal
- Latches are mounted into steel reinforcement plates for long life
- “Spring action” faucet for dripless service
- NSF Listed



Find replacement parts at [www.carlislefsp.com/replacement-parts](http://www.carlislefsp.com/replacement-parts)



Prod No	Description	Color	Pack
<b>Cateraide XT Beverage Servers</b>			
XT2500 Δ	2.5 gal Beverage Server	01, 03, 08*, 59	1 ea
XT5000 Δ	5 gal Beverage Server	01, 03, 08, 59	1 ea
XT10000 Δ	10 gal Beverage Server	01, 03, 08*, 59*	1 ea

NSF Listed products are designated with a Δ and may be prefixed with an N

NOTE: XT10000 can be shipped UPS/FedEx Ground at oversize cost

\* Color available by special order only





## LD Series Insulated Beverage Dispensers

- Made of rugged, stain- and scratch-resistant polyethylene
- Filled with extra thick foam insulation for maximum temperature retention
- Stacks with itself and with other major competitors
- Smooth interior walls and rounded corners leave no food traps and provides quick clean-up
- Convex lid design prevents leaks during use as pressure increases
- Reinforced, tight-fitting lids with O-ring seals prevent leaks and provide increased heat retention
- Easy-grip, formed handles for transporting
- "Spring action" faucet for dripless service
- Nylex II™ latches have no sharp edges, won't rust, bend or dent like metal and are mounted into steel reinforcement plates for long life
- NSF Listed



Find replacement parts at  
[www.carlislefsp.com/replacement-parts](http://www.carlislefsp.com/replacement-parts)



Prod No	Description	Color	Pack
<b>Cateraide LD Beverage Servers</b>			
LD250N Δ	2.5 gal Beverage Server	01, 03	1 ea
LD500N Δ	5 gal Beverage Server	01, 03, 08*, 59	1 ea
LD1000N Δ	10 gal Beverage Server	01, 03, 08*, 59*	1 ea

NSF Listed products are designated with a Δ and may be prefixed with an N

NOTE: LD1000N can be shipped UPS/FedEx Ground at oversize cost

\* Color available by special order only



# CATERAIDE™

## CaterCooler™

- Freeze CaterCooler overnight or for eight hours and it will keep food at or below the ServSafe® guidelines of 40°F for up to eight hours without ice\*
- Designed to slide into a Cateraide End Loader, Double End Loader or place on top of food pans in a Top Loader
- Durable polyethylene shell

ServSafe® is a registered trademark of the National Restaurant Association

\*Temperature retention is based on CaterCooler being pre-frozen for a minimum of eight hours, then placed directly into Cateraide pan carrier. Pan Carrier unit is then filled with pre-chilled food pans. Testing was conducted under ambient room temperatures of 76°F.

CaterCooler shown with PC300N End Loader



PC660



## Pan Carriers

- Cateraide construction made of rugged, stain- and scratch-resistant polyethylene
- Filled with extra thick foam insulation for maximum temperature retention
- Exclusive automatic self-venting system eliminates unsanitary vent openings and easily lost vent caps
- Heat resistant to 200°F
- Find replacement parts at [www.carlislefsp.com/replacement-parts](http://www.carlislefsp.com/replacement-parts)
- NSF Listed

Use with StorPlus™ Food Pans or DuraPan™ shown on pages 218-225



PC300N

PC600N

## Insulated End Loader

- Individual track for each food pan
- PC300N end loader holds five 2.5" deep pans
- PC600N has twice the capacity of the PC300N
- PC600N's separate compartments enable you to put hot food in one; cold in the other
- Use with CaterCooler (shown above) to help keep foods at ServeSafe® temps longer
- NSF Listed



Brown(01)	Black(03)	Blue(14)	Forest Green(08)	Slate(59)	Brick Red(95)
-----------	-----------	----------	------------------	-----------	---------------

Prod No	Description	Color	Pack
<b>CaterCooler</b>			
PC660	CaterCooler	14	1 ea
<b>Cateraide Insulated End Loaders</b>			
PC300N Δ	End Loader	01, 03, 08, 59, 95	1 ea
PC600N Δ	Double End Loader	01, 03, 08, 59*	1 ea

NSF Listed products are designated with a Δ and may be prefixed with an N

NOTE: LD500NSS can be shipped UPS/FedEx Ground at oversize cost

\* Color available by special order only



### Insulated Sheet Pan & Tray Carrier

- Individual tracks accommodate seven 18" x 26" trays
- Use with sheet pans shown on page 191
- NSF Listed



### Insulated Top Loaders

- Accommodates all third, half and full size food pans
- PC188N top loader holds up to 8" deep food pan
- NSF Listed



### Insulated Soup & Chili Servers - *Ideal for Food Festivals & Outdoor Venues*

- Same high-quality features and construction as our standard Cateraides
- Perfect for transporting and serving soup and chili
- Stacks with 2.5 gallon & 5 gallon beverage servers
- There are no faucets
- NSF Listed



Prod No	Description	Color	Pack
<b>Cateraide Insulated Sheet Pan &amp; Tray Carrier</b>			
TC1826N Δ	Sheet Pan, Tray Carrier	01, 03	1 ea
<b>Cateraide Insulated Top Loaders</b>			
PC140N Δ	12 qt, 4" Single Pan Carrier	01, 03*	1 ea
PC160N Δ	18 qt, 6" Single Pan Carrier	01, 03	1 ea
PC180N Δ	24 qt, 8" Combination Pan Carrier	01, 03*	1 ea
<b>Cateraide Insulated Soup &amp; Chili Servers</b>			
LD350N Δ	3.5 gal Soup & Chili Server	01, 03	1 ea
LD500NSS Δ	5 gal Soup & Chili Server	01, 03	1 ea

NSF Listed products are designated with a Δ and may be prefixed with an N

\* Color available by special order only



# CATERAIDE™

## Dollies - *Industry Leader*

### Polyethylene Dollies

- 4" heavy-duty, quiet and non-marking swivel casters
- Rolls easily on carpeted floors
- DL300R holds up to two Cateraide End Loaders (PC300N) or any Cateraide Top Loader
- XDL3000 holds up to two Slide 'N Seal End Loaders (XT3000R) when stacked
- NSF Listed



DL300R

XDL3000H



### Aluminum Dollies

- Made of sturdy, light-weight, no-rust aluminum
- Plastic coated corner bumpers protect against marring furnishings
- 4" heavy-duty, quiet and non-marking swivel casters
- Rolls easily on carpeted floors
- DL300 holds up to two stacked Cateraide End Loaders
- DL1826 holds up to three stacked Sheet Pan Carriers



DL1826

DL300



Use Carlisle Utility Carts on page 318 to transport Cateraides



PC300 with DL300R

Black(03)	Aluminum(23)
-----------	--------------

Prod No	Description	Color	Pack
<b>Polyethylene Cateraide Dollies</b>			
XDL3000H Δ	22.38" x 28.75" Dolly with Handle	03	1 ea
DL300R Δ	20.38" x 26.75" Dolly	03	1 ea
<b>Aluminum Cateraide Dollies</b>			
DL300	23.25" x 16.88" Dolly	23	1 ea
DL1826	28.63" x 22" Dolly	23	1 ea

NSF Listed products are designated with a Δ and may be prefixed with an N  
 NOTE: Cateraide Universal Dolly is not UPS/FedEx Ground shippable



## Insulated Ice Caddies

- Cateraide construction made of rugged, stain- and scratch-resistant polyethylene
- Filled with extra thick foam insulation for maximum temperature retention
- Rounded inside corners and removable lid for thorough cleaning
- Stainless steel, reinforced hinges prevent rusting
- Easy rolling, heavy-duty 5" casters
- Find replacement parts at [www.carlislefsp.com/replacement-parts](http://www.carlislefsp.com/replacement-parts)

### 200 Lb Caddy

- Lid opens and lays flat against side of unit to conserve space
- Front faucet for fast drainage and easy cleanup; inside has sloped base for complete drainage
- Includes convenient shelf; allows water to drain away from ice
- Dual handles for easy maneuverability
- 10" non-marking back wheels roll easily over rough surfaces



IC2220

### 125 Lb Caddies

- Nylex™ latches eliminate sharp edges; won't rust, bend or dent
- Ice Caddies IC2250 and IC2254 are only 28.75" high for smaller, more compact space requirements
- IC2250T Ice Caddy is 36.5" high to reduce back bending motion
- IC2250T Ice Caddy has 8" non-marking back wheels for easy maneuvering over rough surfaces
- NSF Listed



IC2250T

IC2254



Prod No	Description	Color	Pack
<b>Cateraide Ice Caddies</b>			
IC2220	200 lb Ice Caddy with Ice Caddy Shelf; 10" Wheels, 2 Swivel Casters (one with brake)	01*, 03, 08*, 59*	1 ea
IC2250 Δ	125 lb Ice Caddy; 2 Rigid Casters, 2 Swivel Casters (one with brake)	01*, 03	1 ea
IC2254 Δ	125 lb Ice Caddy; 4 Swivel Casters (one with brake)	01*, 03	1 ea
IC2250T Δ	125 lb Tall Ice Caddy; 8" Wheels, 2 Swivel Casters (one with brake)	03	1 ea

NSF Listed products are designated with a Δ and may be prefixed with an N

Note: Ice Caddies cannot ship UPS/FedEx Ground

\* Color available by special order only



Mrs. Kari

FRANCISTUTTLE  
TECHNOLOGY CENTER

**CARLISLE**  
FOODSERVICE PRODUCTS

QUALITY  
DURABLE  
STRONG  
**PROFESSIONAL  
COOKWARE**

---

*Carlisle cookware and bakeware are designed to support professional chefs, helping them to succeed in their constant pursuit to delight their guests with great food. Our wide selection of top-quality products delivers reliable, long-lasting value to your operation.*





# FRY PANS

Excalibur Fry Pans feature a **stainless steel reinforced, non-stick layer** to protect from daily wear and tear. The coating is micro-bonded to the pan creating a multi-layer surface that **effortlessly releases food** and resists scratching better than traditional non-stick surfaces.

## Excalibur® Fry Pans

- Scratch-resistant surface resists wear and tear from metal utensils better than any other coating
- Non-stick surface cooks evenly without requiring added fat or oil to release food
- Hardened 3004 Aluminum Alloy body resists denting and maintains shape
- Triple rivet handle stands up to daily use within today's industrial kitchens
- Removable Dura-Kool sleeve keeps handle cool to the touch
- NSF Listed; dishwasher safe



Use with High Heat Turner shown on page 213

## Teflon Select® Fry Pan

- Scratch-resistant surface is 75% more resistant to scratches than regular Teflon
- Non-stick surface cooks evenly without requiring added fat or oil to release food; ideal for pancakes and omelet stations
- Triple rivet handle stands up to daily use within today's industrial kitchens
- Removable Dura-Kool sleeve keeps handle cool to the touch
- Hardened 3004 Aluminum Alloy resists denting and maintains shape
- NSF Listed; dishwasher safe



Prod No	Description	Cover	Pack
<b>Excalibur Fry Pans</b>			
60907XRS	7" Excalibur Fry Pan	60907C	12 ea
60908XRS	8" Excalibur Fry Pan	60908C	12 ea
60910XRS	10" Excalibur Fry Pan	60910C	6 ea
60912XRS	12" Excalibur Fry Pan	60912C	6 ea
60914XRS	14" Excalibur Fry Pan	60914C	3 ea
<b>Teflon Select Fry Pans</b>			
60907SERS	7" Teflon Select Fry Pan	60907C	12 ea
60908SERS	8" Teflon Select Fry Pan	60908C	12 ea
60910SERS	10" Teflon Select Fry Pan	60910C	6 ea
60912SERS	12" Teflon Select Fry Pan	60912C	6 ea
60914SERS	14" Teflon Select Fry Pan	60914C	3 ea

NSF Listed products are designated with a and may be prefixed with an N  
 Teflon® is a registered trademark of E.I. DuPont® DeNemours & Co., Inc.  
 Excalibur® is a registered trademark of Whitford B. U. Corp.





Covers sold separately on page 186  
Recommended covers listed in the product charts

## Traditional Aluminum Fry Pans

- Hard 3004 aluminum body stands up to the toughest foodservice environment
- Gently sloped sides are ideal for turning, flipping and removing foods
- Aluminum provides excellent heat transfer
- NSF Listed



## SSAL™ Fry Pans

- Finest 18-8 stainless interior is permanently bonded to hard aluminum body to create the ultimate fry pan for any foodservice environment
- Aluminum body ensures maximum heat transfer throughout the pan and eliminates hot spots and scorching
- Easy care stainless interior is incredibly durable and will not react with food or discolor sauces
- Special rivet design securely attaches handle to pan; bond will not loosen like traditional rivets
- NSF Listed



Prod No	Description	Cover	Pack
<b>Traditional Aluminum Fry Pans</b>			
60907RS	7" Aluminum Fry Pan	60907C	12 ea
60908RS	8" Aluminum Fry Pan	60908C	12 ea
60910RS	10" Aluminum Fry Pan	60910C	6 ea
60912RS	12" Aluminum Fry Pan	60912C	6 ea
60914RS	14" Aluminum Fry Pan	60914C	3 ea
<b>SSAL Fry Pans</b>			
60708RS	8" SSAL Fry Pan	60908C	12 ea
60710RS	10" SSAL Fry Pan	60910C	6 ea
60712RS	12" SSAL Fry Pan	60912C	6 ea

NSF Listed products are designated with a and may be prefixed with an N



# COOKWARE

## Standard Weight Aluminum Cookware

Standard Weight Aluminum Cookware is made from 3003 alloy that allows cookware to heat rapidly and retain even heat. A double thick top edge and base offer superior strength and shape retention. All Standard Weight Aluminum Cookware is NSF Listed.



### Stock Pots

- Perfect for preparing soups, pastas or long-simmering stocks and sauces
- Can also be used with our stainless steel baskets for steaming, boiling or deep frying

### Braziers

- Brazier's wide surface is perfect for browning meats and simmering stews
- Heavy plated loop handles for easy transport
- Optional covers maintain moist heat for slow cooking



Covers sold separately on page 186  
Recommended covers listed in the product charts

Prod No	Description	Cover	Pack
<b>Standard Weight Stock Pots</b>			
61210	10 qt Standard Weight Stock Pot	61210C	1 ea
61212	12 qt Standard Weight Stock Pot	61210C	1 ea
61216	16 qt Standard Weight Stock Pot	61216C	1 ea
61220	20 qt Standard Weight Stock Pot	61220C	1 ea
61224	24 qt Standard Weight Stock Pot	61224C	1 ea
61232	32 qt Standard Weight Stock Pot	61232C	1 ea
61240	40 qt Standard Weight Stock Pot	61240C	1 ea
61260	60 qt Standard Weight Stock Pot	61260C	1 ea
<b>Standard Weight Braziers</b>			
61115	15 qt Standard Weight Brazier	61232C	1 ea
61120	20 qt Standard Weight Brazier	61120C	1 ea
61125	25 qt Standard Weight Brazier	61125C	1 ea
61130	30 qt Standard Weight Brazier	61130C	1 ea

NSF Listed products are designated with a and may be prefixed with an N



### Tapered Aluminum Sauce Pans

- Tapered shape reduces contact with direct heat source and encourages cooking by diffusing heat from the side walls
- Sides are gently sloped and corners are rounded for easy stirring
- Tapered design nests for convenient storage
- Extra wide lip adds durability and offers more precise pouring
- 8.5 & 10 qt saucepan have side handle to aid lifting



### Sectional Pasta Cookers

- Ideal for pasta, vegetables and seafood
- Save time, energy and space by cooking multiple portions in one pot
- Stainless steel inserts with .13" holes feature cool-touch handles and can be hooked on the side of the pot for easy draining
- Complete unit includes 20 qt pot and 4 quarter size inserts

### Double Boiler

- Heavy-duty construction and extra thick base for superior thermal conductivity; prevents scorching of delicate sauces, chocolate and more
- Traditional weight, satin finish cookware
- Durable rolled edge with sanitary open bead
- Double boiler includes stock pot, insert and cover; inserts are also available separately
- NSF Listed



Prod No	Description	Cover	Pack
<b>Standard Weight Tapered Sauce Pans</b>			
61702	2.5 qt Tapered Sauce Pan	61702C	6 ea
61704	4.5 qt Tapered Sauce Pan	61704C	6 ea
61707	6 qt Tapered Sauce Pan	61707C	6 ea
61708	8.5 qt Tapered Sauce Pan	61708C	6 ea
61710	10 qt Tapered Sauce Pan	61710C	6 ea
<b>Sectional Pasta Cooker</b>			
60100PC	Quarter Size Sectional Pasta Cooker includes 20 qt pot with 4 inserts	—	1 ea
60102	20 qt Pot for Pasta Cooker Combination	—	2 ea
60101	Quarter Size Perforated Insert	—	4 ea
<b>Double Boilers</b>			
60921	12 qt Double Boiler with 12 qt Insert	—	1 ea
60934	20 qt Double Boiler with 16 qt Insert	—	1 ea

NSF Listed products are designated with a and may be prefixed with an N



# COOKWARE

## Heavy-Duty Covers

- Carlisle's unique reinforced design resists dents and holds its shape better than old-fashioned lids
- Extra heavy-duty covers are fabricated from hard 3004 aluminum to stand up to the toughest foodservice environment
- Open looped handles are securely riveted
- NSF Listed



## Domed Fry Pan Covers

- Domed covers fit snugly on the pans creating a self-basting effect by allowing moisture to condense and return to the pan
- Strong welds on handle ensure long life
- NSF Listed



Prod No	Description	Pack
<b>Heavy-Duty Covers</b>		
61120C	Cover for 61120	6 ea
61125C	Cover for 61225	6 ea
61130C	Cover for 61130	6 ea
61210C	Cover for 61210 & 61212	6 ea
61216C	Cover for 61216	6 ea
61220C	Cover for 61220	6 ea
61224C	Cover for 61224	6 ea
61232C	Cover for 61232 & 61115	6 ea
61240C	Cover for 61240	6 ea
61260C	Cover for 61260	6 ea
61702C	Cover for 61702	6 ea
61704C	Cover for 61704	6 ea
61707C	Cover for 61707	6 ea
61708C	Cover for 61708	6 ea
61710C	Cover for 61710	6 ea
<b>Domed Fry Pan Covers</b>		
60907C	7" Dome Fry Pan Cover	6 ea
60908C	8" Dome Fry Pan Cover	6 ea
60910C	10" Dome Fry Pan Cover	6 ea
60912C	12" Dome Fry Pan Cover	6 ea
60914C	14" Dome Fry Pan Cover	3 ea

NSF Listed products are designated with a and may be prefixed with an N



## Mesh Baskets

### Nickel Plated

- Perfect for cooking or reheating single servings of pasta
- Baskets can also be used for small batch frying or breading
- Stainless baskets feature cool-touch handles and heavy-duty chrome steel hook for draining basket

### Chrome Plated

- Chrome plated carbon steel basket is designed for small batch deep frying
- Chrome plated carbon basket not intended for use in water



## Burger Cover

- Accelerates cooking on grill tops
- Aluminum cover provides quick and even heating for thorough cooking
- Helps retain flavor and moisture
- Heat resistant knob is cool to the touch



Prod No	Description	Pack
<b>Nickel Plated Mesh Baskets</b>		
601028	8.75" Fryer Basket	12 ea
601029	9.75" Fryer Basket	12 ea
601031	11.5" Fryer Basket	12 ea
<b>Chrome Plated Carbon Steel Mesh Baskets</b>		
601000	8.75" Fryer Basket	12 ea
601001	9.75" Fryer Basket	12 ea
601002	11.5" Fryer Basket	12 ea
601003	13.5" Fryer Basket	12 ea
<b>Burger Cover</b>		
60103	6" Burger Cover	12 ea

NSF Listed products are designated with a and may be prefixed with an N



# BAKEWARE

## Roast & Bake Pans

- Extra large, heavy-duty sizes capable of holding multiple roasts, hams or turkeys
- Reinforced rolled edge for added strength
- 60306, 601923 have securely riveted drop handles for easier and safer lifting of heavy loads
- NSF Listed



601922



60306



601923

Prod No	Description	Pack
<b>Roast &amp; Bake Pans</b>		
60306	21 ga, 8 qt Bake Pan with Drop Handles; 17" x 11" x 2.5"	6 ea
601922	17 ga, 13.5 qt Bake Pan; 26" x 18" x 2.25"	6 ea
601923	17 ga, 19 qt Bake Pan with Drop Handles; 26" x 18" x 3.5"	4 ea

NSF Listed products are designated with a and may be prefixed with an N



## Commercial Weight Double Roasters

- Commercial weight aluminum roasters are equipped with 2 steel reinforced bands for extra heavy usage
- Pans feature seamless drawn sanitary open bead
- Covers and bases can also be used individually as open roasters
- Full size pans fit standard baker's racks
- Drop handles are securely riveted
- 60345's fabricated lugs hold top securely in place
- NSF Listed



Prod No	Description	Pack
<b>Commercial Weight Double Roasters</b>		
60346	Double Roaster; 24" x 18" x 9" (includes 60344 & 60345)	1 ea
60344	16 ga, 26 qt Roast Pan (use as cover); 24" x 18" x 4.5"	2 ea
60345	16 ga, 26 qt Roast Pan (use as base); 24" x 18" x 4.5"	2 ea

NSF Listed products are designated with a and may be prefixed with an N



# BAKEWARE

## Aluminized Steel Pans

### Heavy-Duty Muffin Pan

- Heavy-duty muffin pan has seamless cups locked into heavy aluminum frame
- Holds up in busy foodservice environments



602424

### Baking Pans

- Aluminized steel pans are the ultimate choice for baking breads, cupcakes, muffins and cakes
- The special finish provides greater heat transfer for lower baking temperatures, shorter baking time and better looking, more uniform baked goods
- Corrosion-resistant material withstands temperatures in excess of 700°F
- Individual seamless cups are locked into heavy frames



601837  
601834  
601840  
601829

### Bread Pans & Pullman Pans

- Aluminized steel pans are the ultimate choice for baking breads and cakes



604144

604174



606903

606902

Prod No	Description	Pack
<b>Aluminized Steel Baking Pans</b>		
601829	24 Cup/1.75 oz Mini-Muffin/Cupcake Pan*	6 ea
601830	12 Cup/3.5 oz Heavy-Duty Cupcake Pan	12 ea
601840	24 Cup/3.5 oz Heavy-Duty Cupcake Pan	6 ea
601834	12 Cup/4 oz Large Cup Cupcake Pan	6 ea
601837	12 Cup/6 oz Extra Large Cup Cupcake Pan	6 ea
606902	6 Loaf Mini Loaf Pan (Loaf Size: 4" x 2.5" x 2.25")	6 ea
606903	12 Loaf Mini Loaf Pan (Loaf Size: 4" x 2.5" x 1.38")	6 ea
<b>Aluminized Steel Bread Pans</b>		
604144	1 lb Loaf Bread Pan, 9.5" x 5" x 2.77"	12 ea
604174	1.75 lb Loaf Bread Pan, 12.8" x 5" x 2.8"	12 ea
<b>Heavy-Duty Muffin Pan</b>		
602424	24 Cup/3 oz Aluminum Muffin Pan*	12 ea

\*Handwashing recommended





## Bun Pans & Sheet Pans

- Sturdy bun pans for baking, transporting and displaying cookies, bread and pastries
- Aluminum surface allows even browning of foods
- Manufactured from extra hard, tempered aluminum alloy with galvanized steel wire reinforced bead
- Tapered shape stacks for storage
- Use with Icing Grates listed below



## Icing Grates

- Use grates for thawing foods or cooling and icing cakes, cookies and desserts
- 601306 welded icing grate fits full size bun pans and is made of nickel plated steel
- 601642, 601647 mesh icing grates are made of heavy, steel mesh wire



Prod No	Description	Pack
<b>Bun Pans &amp; Sheet Pans</b>		
601825	18 ga, Full Size Sheet Pan; 25.75" x 17.81" x 1.13"	12 ea
601826	16 ga, Heavy-Duty Full Size Sheet Pan; 25.75" x 17.81" x 1.13"	12 ea
601824	18 ga, Half Size Bun Pan; 17.81" x 12.88" x 1"	12 ea
601828	18 ga, Perforated Full Size Sheet Pan; 25.75" x 17.81" x 1.13"	12 ea
<b>Icing Grates</b>		
601306	Icing Grate, Fits 601825, 601826, 601828 Bun Pan	12 ea
601642	Mesh Icing Grate, Fits 601824 Bun Pan	12 ea
601647	Mesh Icing Grate, Fits 601825, 601826, 601828 Bun Pan	12 ea



**CARLISLE**  
FOODSERVICE PRODUCTS

QUALITY  
EFFICIENT  
DURABLE  
INNOVATIVE  
**KITCHEN  
ACCESSORIES**

---

*Designed and used by chefs, Carlisle kitchen accessories are created to improve food safety, promote quality, save labor and reduce waste. For efficient kitchen operations day after day you can count on Carlisle to help make work easier.*





# ALLERGEN CONTROL PRODUCTS

In a kitchen, the **most dangerous allergen** is the one that isn't identified. Carlisle **Allergen Control Products** help your employees segregate their allergen sensitive orders ensuring a safer dining experience for your customers.

## The Big 8

The big 8 are the principal allergenic foods that account for nearly 90% of all food allergies in the United States

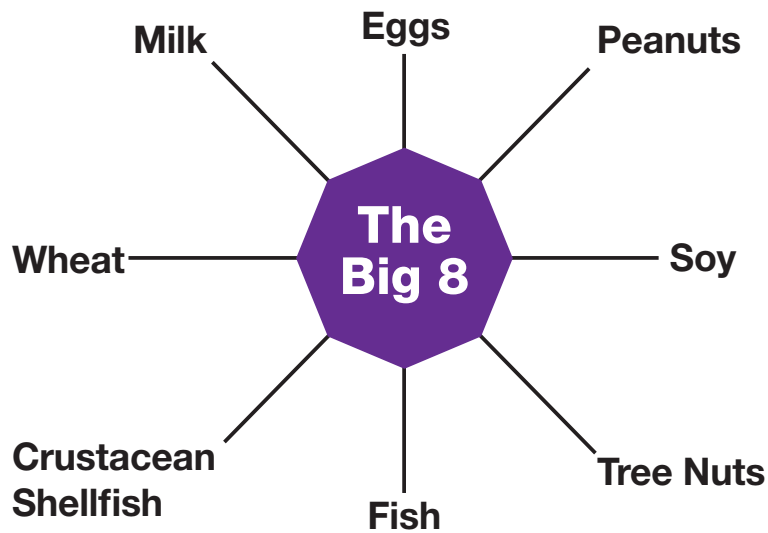

### *Symptoms of an Allergic Reaction*

Nausea	Wheezing / Shortness of Breath	Hives / Itchy Rashes
Swelling of Face, Eyes, Hands or Feet	Vomiting / Diarrhea	Abdominal Pain



Capacity indicators allow measuring, prepping and portioning in a single container for added versatility, efficiency and inventory control



StorPlus Square Container  
Pages 228-229

Bold purple markings make these measuring cups easy to read



Commercial Measuring Cup  
Page 204

Carlisle offers purple Measure Misers in a variety of sizes with the capacity molded into the handle for portion control



Measure Misers  
Page 207

Purple tote boxes are perfect for ensuring that cross-contamination doesn't happen during the cleaning process



Comfort Curve Tote Boxes  
Page 252

Purple Bronco Waste Containers are NSF Listed for food contact and cleanability—perfect for food storage



Bronco Waste Containers  
Pages 324-325



# HEAT LAMPS

## Heat Lamps

- Wide selection of heat lamps for both front-of-the-house buffet service and back-of-the-house temperature retention
- 1-year limited warranty

## Flexiglow™

- Spun aluminum shade with flared rim for added strength
- Shade is drilled for increased heat dissipation
- Optional NSF Listed maple cutting board and drip pan is perfect for a front-of-the-house carving station
- Meets standard electrical specifications shown on page 197
- Rated UL recognized

### Dual Arm Flexiglow

- Two flex arms provide heating for separate products
- Vinyl-coated arms help keep unit sanitary
- Includes two 250-watt Red bulbs

### Single Arm Flexiglow

- Switch located away from the heat source
- Includes 250 watt Red bulb



HL8285GB



HL8195B



HL8185



HLA20



HL8285

## Two Bulb Adjustable

- Adjustable arm for different heat settings
- Spun aluminum shades with flared rim for added strength and more even heat dissipation
- Ceramic insulated sockets with nickel plated contacts to prevent fusing
- Meets Standard Electrical Specifications shown on below
- On/Off switch mounted on arm away from heat zone
- Includes two 250-watt Clear bulbs
- UL & CSA listed



### Standard Electrical Specifications

- Sockets are ceramic insulated and furnished with a nickel-plated copper screw shell and contact point to prevent fusing
- Internal wiring is braided and silicone covered and rated 200°C
- Durable 16 gauge external wiring with molded three-prong plug
- All switches are either “T” or “L” rated and surpass minimum requirements
- All switches are located out of the heat zone
- Designed to operate on 110-120 volt AC service; wiring will accommodate 250 volt AC service
- Heat lamps have one year warranty against defects in materials and workmanship

Find replacement parts at  
[www.carlislefsp.com/replacement-parts](http://www.carlislefsp.com/replacement-parts)

Aluminum(00)	Designated(00)*	Gold(21)
--------------	-----------------	----------

Prod No	Description	Color	Pack
<b>Flexiglow Heat Lamps</b>			
HL8285 <span style="color: blue;">▲</span>	Dual Arm Flexiglow, Aluminum, 24" Arm	00	1 ea
HL8285G <span style="color: blue;">▲</span>	Dual Arm Flexiglow, Gold, 24" Arm	21	1 ea
HL8285B** <span style="color: blue;">▲</span>	Dual Arm Flexiglow with Board & Pan, Aluminum, 24" Arm	00	1 ea
HL8285GB** <span style="color: blue;">▲</span>	Dual Arm Flexiglow with Board & Pan, Gold, 24" Arm	21	1 ea
HL8185 <span style="color: blue;">▲</span>	Flexiglow, Aluminum, 24" Arm	00	1 ea
HL8185G <span style="color: blue;">▲</span>	Flexiglow, Gold, 24" Arm	00*	1 ea
HL8185C	Flexiglow, Aluminum, 24" Arm, Includes Clamp	00	1 ea
HL8185GC	Flexiglow, Gold, 24" Arm, Includes Clamp	00*	1 ea
HL8185B** <span style="color: blue;">▲</span>	Flexiglow with Board & Pan, Aluminum, 24" Arm	00	1 ea
HL8185GB** <span style="color: blue;">▲</span>	Flexiglow with Board & Pan, Gold, 24" Arm	21	1 ea
HLA20	Flexiglow Clamp (8100 & 8200 Series)	00*	1 ea
HL8195 <span style="color: blue;">▲</span>	Flexiglow Aluminum, 39" Arm	00	1 ea
HL8195B** <span style="color: blue;">▲</span>	Flexiglow with Board, Aluminum, 39" Arm	00	1 ea
<b>Two Bulb Adjustable Heat Lamp</b>			
HL7237 <span style="color: blue;">▲</span>	Two Bulb Free Standing Adjustable Heat Lamp	00	1 ea
HL7237PS	Two Bulb Free Standing Adjustable Heat Lamp with 13" x 21" SS Pan & Screen	00	1 ea

NSF Listed products are designated with a ▲ and may be prefixed with an N

\*\*Includes 18" x 26" drip pan and 16" x 24" maple cutting board

Note: To allow for choice of lamp placement, holes in board are not pre-drilled

Note: HL8185B, HL8185GB, HL8195, HL8195B, HL8285, HL8285G, HL8285B, HL8285GB can be shipped UPS/FedEx Ground at oversize cost

Note: Heat Lamps sold or shipped outside the U.S. do not include a plug or bulb(s)



# ORDER WHEELS AND RACKS

## Order Wheels

- Keeps orders in clear view during preparation
- Rugged stainless steel construction
- Unique ball/spring clips for easy, one-handed check placement
- Custom length (381EX) extensions available for counter and ceiling mount models

### Counter Mount Model

- Wheel mounts to any counter
- 9" extension & plate included

### Ceiling Hung Model

- Square "CH" plate on top of axle mounts to ceiling with 4 screws

**Note: Ceiling hung model does not include an extension. Extender must be purchased separately**

### Wall Mounted Model

- Wheel mounts to any wall
- Extension & plate included

### Pedestal Model

- Heavy chrome 10" round base won't tip
- Rubber footprint prevents slipping and protects counter tops
- Includes 9" extension for adjustable height



3816MP



3812CH



3812CM



3816WH

Find replacement parts at [www.carlislefsp.com/replacement-parts](http://www.carlislefsp.com/replacement-parts)

## Slide Order Racks

- Ball-bearing action provides clean look & one-handed sliding action
- Choose from rugged stainless steel or economical aluminum options
- Custom lengths are available by special order



38240A

38360

Prod No	Description	Pack
<b>Order Wheels</b>		
3812MP	12 Clip, 14" Portable Order Wheel	1 ea
3816MP	16 Clip, 18" Portable Order Wheel	1 ea
3820MP	20 Clip, 23" Portable Order Wheel	1 ea
3812CM	12 Clip, 14" Counter Mount Order Wheel	1 ea
3812CH	12 Clip, 14" Ceiling Hung Order Wheel	1 ea
3816CH	16 Clip, 18" Ceiling Hung Order Wheel	1 ea
3820CH	20 Clip, 23" Ceiling Hung Order Wheel	1 ea
3816WH	16 Clip, 18" Wall Mounted Order Wheel with 9" Extension	1 ea
<b>Slide Order Racks</b>		
38360	36" Stainless Steel Slide Order Rack	3 ea
38480	48" Stainless Steel Slide Order Rack	3 ea
38180A	18" Aluminum Slide Order Rack	3 ea
38240A	24" Aluminum Slide Order Rack	3 ea
38360A	36" Aluminum Slide Order Rack	3 ea
38480A	48" Aluminum Slide Order Rack	3 ea



## Ice Only Container

- Safely and easily transports small loads of ice
- Perfect for filling food bars or other iced food displays, ice bins on portable bars or even automatic ice dispensers at self-serve beverage stations
- Heavy-duty construction and ergonomic Comfort Curve™ handles provide easy handling; deep hand holds on base for controlled tipping
- Lids are reinforced and have snap down tab lock
- Imprinted on two sides in both English & Spanish
- NSF Listed



## Scoops

- Great economical choice for your front and back of house ice handling needs.

### Metal Scoops

- Heavy-duty scoops have easy to hold pistol-grip handles with clearly marked capacities



### Polycarbonate Scoops

- Easy-grip plastic handle doesn't transfer cold
- Features a hole for hanging or tying to a container
- Durable polycarbonate material
- NSF Listed; dishwasher safe

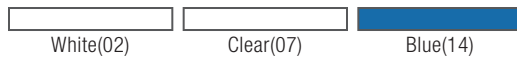

Prod No	Description	Color	Pack
<b>Ice Only Container &amp; Lid</b>			
341010ICE $\Delta$	10 gal Ice Only Container	02	6 ea
341011	10 gal Ice Only Container Lid	02	6 ea
<b>Scoops</b>			
606040	38 oz Solid Cast Aluminum Scoop	—	12 ea
606055	58 oz Solid Cast Aluminum Scoop	—	12 ea
606086	85 oz Solid Cast Aluminum Scoop	—	12 ea
4306 $\Delta$ $\blacklozenge$	6 oz Polycarbonate Scoop	07	12 ea
4332 $\Delta$ $\blacklozenge$	32 oz Polycarbonate Scoop	07	12 ea
4364 $\Delta$ $\blacklozenge$	64 oz Polycarbonate Scoop	07	6 ea

NSF Listed products are designated with a  $\Delta$  and may be prefixed with an N

$\blacklozenge$  California Residents: Bisphenol A **WARNING:** See appendix A on page 1



# SPARTA® PASTRY & BASTING BRUSHES

**Sparta** Pastry & Basting Brushes have been the **top choice** of discriminating professional chefs the world over for decades. The **high-quality craftsmanship** provides the **best bristle retention in the industry**. You should never sacrifice food safety and with our wide selection of brushes, we have a brush to cover **all of your needs**.



**TOP SELLER**

**SPARTA®**  
**BRUSH**  
Famous for Quality

**Other Brands**

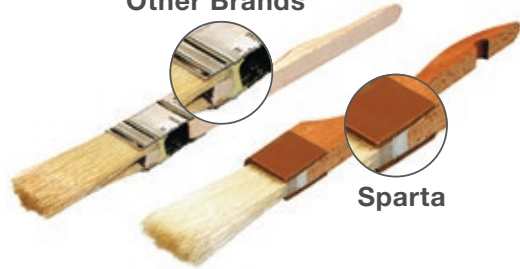

**Sparta**

**Superior Food Safety Construction**

Epoxy-set ferrules on all Sparta Pastry/Basting Brushes are especially designed for foodservice use; eliminating hazardous bacteria traps commonly found in other brushes. Sparta Pastry/Basting Brushes are available in a wide range of sizes and styles.

## Chef Series™ Brushes

- Professional, high-quality lacquered hardwood handles with brown plastic ferrules are the choice of top chefs
- Bristles are epoxy-set to ferrules to provide superior bristle retention and to prevent bacteria harboring air pockets

### Sparta Chef Series Croissant Brush

- Extra long bleached boar bristles for use on the most delicate of pastries and foods



## Chef Series Basting Brushes

- The professional's choice for use in basting meats and poultry
- Durable sterilized, double-boiled, bleached boar bristles
- Withstands temperatures of up to 500°F

Note: Basting brushes should not be cleaned in dishwashers. Brushes should be dipped in a commercial cleaning solution and rinsed.



For usage information on these and other brushes included in our 21 Key Brushes Set, check out our 21 Key Brush Guide on pages 253-255



Standard(00)

Prod No	Description	Color	Pack
<b>Sparta Chef Series Croissant Brush</b>			
40377	1.5" Wide Brush with Boar Bristles	00	12 ea
<b>Sparta Chef Series Basting Brushes</b>			
40370	12" Handle with 2" Wide Brush with Boar Bristles	00	12 ea
40371	12" Handle with 4" Wide Brush with Boar Bristles	00	12 ea
40372	1" Wide Flat Brush with Boar Bristles	00	12 ea
40373	1.5" Wide Flat Brush with Boar Bristles	00	12 ea
40374	2" Wide Flat Brush with Boar Bristles	00	12 ea
40375	3" Wide Flat Brush with Boar Bristles	00	12 ea
40376	4" Wide Flat Brush with Boar Bristles	00	12 ea
40380	1" Round Brush with Boar Bristles	00	12 ea



## Chef Series Pastry Brushes

- Soft, flagged, white nylon bristles have high fluid retaining capacity and provide a soft touch to delicate pastries
- The finest commercial brushes of their kind
- Offers the performance, delicate touch and long-lasting value by which all others are judged



## Meteor Pastry/Basting Brushes

- “Molded-into-the-handle” hook hangs on lip of crocks and containers to prevent bristle burn, melt or distortion
- Use hook to elevate bristles off of counter tops
- Soft flagged bristles are molded into handle to prevent bacteria harboring air pockets
- Available with white nylon bristles or double-boiled, bleached, sterilized, premium boar bristles

Hook hangs on side of crock or elevates bristles off counter tops



### Bristles | Heat Distortion Point

<b>Synthetic</b>	Up to 350°F (176.7°C)
<b>Boar</b>	500°F (260°C)
<b>Silicone</b>	500°F (260°C)



Prod No	Description	Color	Pack
<b>Sparta Chef Series Pastry Brushes</b>			
40395	1" Wide Brush with Nylon Bristles	—	12 ea
40396	1.5" Wide Brush with Nylon Bristles	—	12 ea
40397	2" Wide Brush with Nylon Bristles	—	12 ea
40398	3" Wide Brush with Nylon Bristles	—	12 ea
40399	4" Wide Brush with Nylon Bristles	—	12 ea
40400	1" Round Brush with Nylon Bristles	—	12 ea
<b>Sparta Meteor Pastry/Basting Brushes</b>			
40378	2" Wide Brush with Boar Bristles	—	12 ea
40379	3" Wide Brush with Boar Bristles	—	12 ea
40401	2" Wide Brush with Nylon Bristles	02, 14	12 ea
40402	3" Wide Brush with Nylon Bristles	02, 14	12 ea



# SPARTA® PASTRY & BASTING BRUSHES

## Galaxy™ Pastry Brushes

- Bristles are epoxy-set to prevent bacteria harboring air pockets
- One piece plastic handles are easy to clean
- Available with soft flagged nylon bristles
- Select brushes also available with blue nylon bristles for added contrast in working with white frostings or other white foods



## Silicone Basting Brush

- Dishwasher safe
- Unique bristle design carries and spreads liquid better than ordinary Silicone basting brushes
- Withstands temperatures up to 500°F
- Convenient molded-in hanging hook grabs pan edges to keep brush from sliding in
- Stain and odor resistant



Prod No	Description	Color	Pack
<b>Sparta Galaxy Pastry Brushes</b>			
40390	1.5" Wide Flat Brush with Nylon Bristles	02	12 ea
40391	2" Wide Flat Brush with Nylon Bristles	02, 14	12 ea
40392	3" Wide Flat Brush with Nylon Bristles	02, 14	12 ea
40393	4" Wide Flat Brush with Nylon Bristles	02, 14	12 ea
40394	1" Round Brush with Nylon Bristles	02	12 ea
<b>Silicone Basting Brushes</b>			
40403	2" Silicone Basting Brush	05	12 ea
40405	3" Silicone Basting Brush	05	12 ea

## Food Preparation Brushes

### Potato Brush

- Patented brush has stiff polyester bristles for aggressive cleaning along with a unique “scraper edge” grip for removing hard to reach blemishes on potatoes and other firm vegetables

### Vegetable Brush

- Round loop construction, straight handle with firm bristles



## Portioning Cups

- Scoop or transfer ice, liquids or any bulk item
- Features flat sides for efficient scooping on the bottom of bins, food pans or other storage containers
- Made of durable, break-resistant polycarbonate
- Unique U-shaped handle helps keep hands away from food contact areas while scooping
- Sizes are color coded for quick and easy identification
- NSF Listed; dishwasher safe



## One Gallon Container

- Ideal for mixing batters, dressings and drinks
- Assorted color toggle lids allow easy access for quick open and close action and color identification
- Tight sealing lid protects against spills
- Durable translucent polypropylene material makes it easy to see contents
- U.S. and metric measurements printed on side panels
- NSF Listed; dishwasher safe



Standard(00)	Brown(01)	White(02)	Black(03)	Beige(06)
--------------	-----------	-----------	-----------	-----------

Prod No	Description	Color	Pack
<b>Sparta Food Preparation Brushes</b>			
40412	5.75" Potato Brush with Medium Stiff Polyester Bristles	02	12 ea
40164	9.5" Vegetable Brush with Stiff Polyester Bristles	02	12 ea
<b>Portioning Cups</b>			
49110-1 Δ	9.5 oz Portion Cup	02	6 ea
49112-1 Δ	12 oz Portion Cup	06	6 ea
49116-1 Δ	16 oz Portion Cup	01	6 ea
49122-1 Δ	20 oz Portion Cup	03	6 ea
<b>One Gallon Container &amp; Toggles</b>			
6400 Δ	1 Gallon Container	00	2 ea
6401 Δ	Replacement Lid & Assorted Toggles	00	6 ea

NSF Listed products are designated with a Δ and may be prefixed with an N



# MEASURES & SERVING ACCESSORIES

## Commercial Measures

- Made of durable polycarbonate
- Offers easy measuring of wet ingredients
- Available in Cup, Pint, Quart, Half Gallon and Gallon sizes with U.S. and metric measurements
- Oval shape facilitates pouring from non-spouted side
- Family of measures nest for storage
- NSF Listed; dishwasher safe



Measurement markings legible on the inside of the container allow faster, more accurate measurement

## Measuring Cup

- Durable polycarbonate with 1-cup capacity for measuring liquid ingredients
- Withstands temperatures from -40° to 212°F
- Dishwasher safe



Prod No	Description	Color	Pack
<b>Commercial Measures</b>			
43141 $\Delta$ ♦	Cup Size PC Measure	07, AF07	12 ea
43142 $\Delta$ ♦	Pint Size PC Measure	07, AF07	6 ea
43143 $\Delta$ ♦	Quart Size PC Measure	07, AF07	6 ea
43144 $\Delta$ ♦	Half Gallon Size PC Measure	07, AF07	6 ea
43145 $\Delta$ ♦	Gallon Size PC Measure	07, AF07	6 ea
<b>Measuring Cup</b>			
4315 ♦	Measuring Cup	07	6 ea

NSF Listed products are designated with a  $\Delta$  and may be prefixed with an N  
 ♦ California Residents: Bisphenol A **WARNING:** See appendix A on page 1



## Dishers

- Color-coded for easy identification and portion control
- Smooth operating 18-8 stainless steel construction with ribbed plastic handle
- Bowl capacity is stamped on bail
- Number on bail indicates scoops per quart
- NSF Listed; dishwasher safe

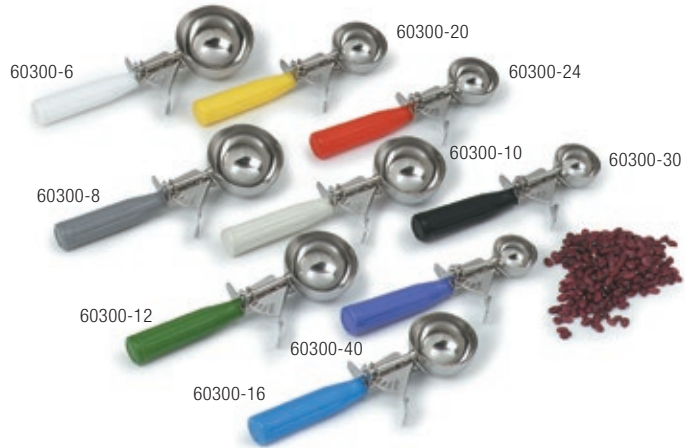

## Stainless Steel Measure Misers®

- Portion control spoons in heavy gauge 18-8 stainless steel with durable one-piece construction
- Feature color-coded Kool-Touch handles and built-in pan edge rest
- Dishwasher safe



**Prod No**      **Description**      **Pack**

### Dishers

60300-6 Δ	4.66 oz Disher with White Handle	12 ea
60300-8 Δ	4 oz Disher with Gray Handle	12 ea
60300-10 Δ	3.75 oz Disher with Ivory Handle	12 ea
60300-12 Δ	3.25 oz Disher with Green Handle	12 ea
60300-16 Δ	2.75 oz Disher with Blue Handle	12 ea
60300-20 Δ	2 oz Disher with Yellow Handle	12 ea
60300-24 Δ	1.75 oz Disher with Red Handle	12 ea
60300-30 Δ	1.25 oz Disher with Black handle	12 ea
60300-40 Δ	.88 oz Disher with Orchid handle	12 ea

### Stainless Steel Measure Misers

604360	2 oz Solid SS Measure Miser, Red	12 ea
604361	2 oz Perforated SS Measure Miser, Red	12 ea
604370	3 oz Solid SS Measure Miser, Beige	12 ea
604371	3 oz Perforated SS Measure Miser, Beige	12 ea
604380	4 oz Solid SS Measure Miser, Green	12 ea
604381	4 oz Perforated SS Measure Miser, Green	12 ea
604390	6 oz Solid SS Measure Miser, Black	12 ea
604392	8 oz Solid SS Measure Miser, Blue	12 ea

NSF Listed products are designated with a Δ and may be prefixed with an N



# MEASURE MISERS®

Measure Misers help your kitchen **deliver consistency** to make work easier, reduce waste and **save you money.**

## Measure Misers

- Portion control spoon made of break-resistant polycarbonate
- Spoon's flat bottom easily spreads sauces or toppings
- Long handle measure misers have thumb grip for steady control and a notch for resting on pan rim
- Recommended for temperatures up to 212°F
- Withstands dry heat up to 270°F
- 2-year limited warranty
- NSF Listed; dishwasher safe



Prod No	Description	Color	Pack
<b>Measure Misers</b>			
<b>Short Handle</b>			
4322 ▲◆	1-1/2 oz, 7.19" Solid Measure Miser w/Red Measurements	06	12 ea
4324 ▲◆	2 oz, 7.13" Solid Measure Miser w/Red Measurements	06	12 ea
4362 ▲◆	2 oz, 7.13" Perforated Measure Miser w/Red Measurements	06	12 ea
4326 ▲◆	3 oz, 8" Solid Measure Miser w/Blue Measurements	06	12 ea
4328 ▲◆	4 oz, 8.25" Solid Measure Miser w/Green Measurements	06	12 ea
4329 ▲◆	4 oz, 8.25" Perforated Measure Miser w/Green Measurements	06	12 ea
4330 ▲◆	6 oz, 8.63" Solid Measure Miser w/Black Measurements	06	12 ea
<b>Standard Handle</b>			
4358 ▲◆	1-1/2 oz, 11.94" Solid Measure Miser w/Maroon Measurements	06	12 ea
4360 ▲◆	2 oz, 11.94" Solid Measure Miser w/Red Measurements	06	12 ea
4361 ▲◆	2 oz, 11.94" Perforated Measure Miser w/Red Measurements	06	12 ea
4370 ▲◆	3 oz, 12.75" Solid Measure Miser w/Blue Measurements	06	12 ea
4371 ▲◆	3 oz, 12.75" Perforated Measure Miser w/Blue Measurements	06	12 ea
4380 ▲◆	4 oz, 13" Solid Measure Miser w/Green Measurements	06	12 ea
4381 ▲◆	4 oz, 13" Perforated Measure Miser w/Green Measurements	06	12 ea
4390 ▲◆	6 oz, 13.38" Solid Measure Miser w/Black Measurements	06	12 ea
4391 ▲◆	6 oz, 13.38" Perforated Measure Miser w/Black Measurements	06	12 ea
<b>Black Measure Misers*</b>			
4360-5 ▲◆	2 oz, 11.94" Solid Measure Miser	03	12 ea
4370-5 ▲◆	3 oz, 12.75" Solid Measure Miser	03	12 ea
4380-5 ▲◆	4 oz, 13" Solid Measure Miser	03	12 ea
4381-5 ▲◆	4 oz, 13" Perforated Measure Miser	03	12 ea
4390-5 ▲	6 oz, 13.38" Solid Measure Miser	03	12 ea

NSF Listed products are designated with a ▲ and may be prefixed with an N  
 \*Black measure misers do not have color-coding

◆ California Residents: Bisphenol A **WARNING:** See appendix A on page 1





**Long lasting acetal** Color-Coded Measure Misers ensure employees **deliver the consistency** your customers expect without compromising durability.

### Color-Coded Measure Misers

- Portion control spoon made of break-resistant acetal material
- Each color represents a different size for easy recognition and consistency
- Spoon's flat bottom easily spreads sauces or toppings
- 4694 features a deep cup style that allows for easier access inside small food pans
- Long handle measure misers have thumb grip for steady control and a notch for resting on pan rim
- Recommended for temperatures up to 212°F
- Withstands dry heat up to 270°F
- BPA Free
- 2-year limited warranty
- NSF Listed; dishwasher safe

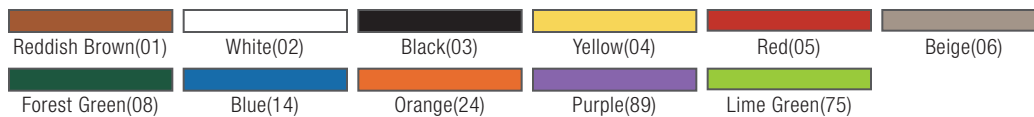

Prod No	Description	Color	Pack	Prod No	Description	Color	Pack
<b>Color-Coded Measure Misers Short Handle</b>				<b>Color-Coded Measure Misers Long Handle</b>			
4921 Δ	1 oz, 6.5" Solid Spoon	04, 89	12 ea	3956 Δ	1 oz, 11.5" Solid Spoon	04, 89	12 ea
4923 Δ	1 oz, 6.5" Perforated Spoon	04	12 ea	3957 Δ	1 oz, 11.25" Perforated Spoon	04	12 ea
4932 Δ	1.25 oz, 7.25" Solid Spoon	75	12 ea	3958 Δ	1.5 oz, 11.5" Solid Spoon	01	12 ea
4965 Δ	1.25 oz, 7.25" Perforated Spoon	75	12 ea	3959 Δ	1.5 oz, 11.5" Perforated Spoon	01	12 ea
4922 Δ	1.5 oz, 7" Solid Spoon	01	12 ea	3960 Δ	2 oz, 11.9" Solid Spoon	05, 89	12 ea
4961 Δ	1.5 oz, 7" Perforated Spoon	01	12 ea	3961 Δ	2 oz, 11.9" Perforated Spoon	05	12 ea
4924 Δ	2 oz, 7.10" Solid Spoon	05, 89	12 ea	3970 Δ	3 oz, 11.75" Solid Spoon	02	12 ea
4962 Δ	2 oz, 7.10" Perforated Spoon	05, 89	12 ea	3971 Δ	3 oz, 11.75" Perforated Spoon	02	12 ea
4925 Δ	2.5 oz, 7.10" oz Solid Spoon	24	12 ea	3980 Δ	4 oz, 13" Solid Spoon	08, 89	12 ea
4963 Δ	2.5 oz, 7.10" Perforated Spoon	24	12 ea	3981 Δ	4 oz, 13" Perforated Spoon	08, 89	12 ea
4926 Δ	3 oz, 8" Solid Spoon	02, 89	12 ea	3990 Δ	6 oz, 13.4" Solid Spoon	03	12 ea
4927 Δ	3 oz, 8" Perforated Spoon	02	12 ea	3991 Δ	6 oz, 13.4" Perforated Spoon	03	12 ea
4928 Δ	4 oz, 8.25" Solid Spoon	08, 89	12 ea	3992 Δ	8 oz, 13.25" Solid Spoon	14	12 ea
4929 Δ	4 oz, 8.25" Perforated Spoon	08	12 ea	3993 Δ	8 oz, 13.25" Perforated Spoon	14	12 ea
4933 Δ	5 oz, 8.62" Solid Spoon	06	12 ea				
4966 Δ	5 oz, 8.62" Perforated Spoon	06	12 ea				
4930 Δ	6 oz, 8.62" Solid Spoon	03, 89	12 ea				
4967 Δ	6 oz, 8.62" Perforated Spoon	03	12 ea				
4964 Δ	6 oz, 8.62" Deep Cup Perforated Spoon	03	12 ea				
4931 Δ	8 oz, 8.62" Solid Spoon	14	12 ea				
4968 Δ	8 oz, 8.62" Perforated Spoon	14	12 ea				

NSF Listed products are designated with a Δ and may be prefixed with an N



# DREDGES, COLANDERS, BOWLS & SKIMMERS

## Metal Dredge

- Heavy-duty seamless dredges in aluminum
- 18-8 mirror polish stainless with wide screw tops for easy filling
- Dishwasher safe



6031

## Shaker/Dredge

- Durable break-resistant polycarbonate shaker can be customized with your logo
- Call Customer Service at 1-800-654-8210 for custom imprinting information; also ask about our BPA-free versions available by special order
- Additional lids can be purchased separately to accommodate different toppings
- Different hole sizes available for portioning materials that vary in size



4261

4271

4251



4230

4270

4250

4260



Prod No	Description	Color	Pack
<b>Metal Dredge</b>			
6031	Alumilite Dredge with Handle	—	12 ea
<b>Polycarbonate Shaker/Dredge &amp; Lids</b>			
4250 ♦	Dredge with Medium Ground, Rose Lid	55	12 ea
4260 ♦	Dredge with Cheese, Yellow Lid	04	12 ea
4270 ♦	Dredge with Salt & Pepper, Beige Lid	06	12 ea
4230 ♦	Dredge with Translucent Parsley Lid	30	12 ea
4231	Translucent Parsley Lid	30	12 ea
4251	Rose Medium Ground Lid	55	12 ea
4261	Yellow Cheese Lid	04	12 ea
4271	Beige Salt & Pepper Lid	06	12 ea
<b>Wire Mesh Skimmers</b>			
601526	6" Bowl Mesh Skimmer	—	12 ea
601527	7" Bowl Mesh Skimmer	—	12 ea
601528	8" Bowl Mesh Skimmer	—	12 ea
601529	9" Bowl Mesh Skimmer	—	12 ea

♦ California Residents: Bisphenol A **WARNING:** See appendix A on page 1

## Colanders

- Seamless satin finish aluminum construction with rolled top edge for extra strength
- Sturdy handles are securely riveted on sides
- Available in extra heavy or standard gauge aluminum



## Spaghetti Strainer

- Heavy gauge aluminum strainer has riveted plated steel handle
- Perfect for rinsing and straining pastas and vegetables
- Front hook for resting on stock pot
- Hole diameter 2.0 Mm
- Dishwasher Safe



## Melamine Mixing Bowls

- Heavy-duty melamine is safe for temperatures up to 212°F
- Bowls are break and stain-resistant
- Not recommended for microwave use
- Dishwasher safe



## Wire Mesh Skimmers

- Heavy-duty construction
- Skimmers lift food from fryer
- Sturdy handles with hanging loops
- Nickel plated construction resists corrosion



Prod No	Description	Color	Pack
<b>Colanders</b>			
60275	11 qt Heavy-Weight Colander	—	6 ea
60277	16 qt Heavy-Weight Colander	—	6 ea
60278	8 qt Standard Weight Colander	—	6 ea
60279	11 qt Standard Weight Colander	—	6 ea
60280	16 qt Standard Weight Colander	—	6 ea
<b>Spaghetti Strainer</b>			
60830	4 qt Spaghetti Strainer	—	12 ea
<b>Melamine Mixing Bowls</b>			
43744	1.5 qt, 8" Mixing Bowl	02, 92	12 ea
43743	3 qt, 9.75" Mixing Bowl	02, 92	12 ea



# COLOR-CODED SPATULAS & SCRAPERS

## Sparta® Spatulas & Paddle Scrapers

- Perfect for general mixing and stirring
- Long handle versions are ideal for vats and large pots
- Stainless steel or nylon/polyethylene scraper available
- Smooth finish, water-proof construction for easy clean-up
- Replacement blades are available for this product



Prod No	Description	Color	Pack
<b>Sparta Spatulas &amp; Paddle Scrapers</b>			
40347 <span style="color: blue;">▲</span>	36" Stainless Steel Paddle Scraper	—	6 ea
40349 <span style="color: blue;">▲</span>	48" Stainless Steel Paddle Scraper	—	6 ea
40359 <span style="color: blue;">▲</span>	60" Stainless Steel Paddle Scraper	—	6 ea
40350	13.5" Nylon Handle with 4.5" x 7.5" Nylon Spatula Scraper	02	6 ea
40351	13.5" Nylon Handle with 4.5" x 7.5" Polyethylene Soft Spatula Scraper	00	6 ea
40352	40" Nylon Handle with 4.5" x 7.5" Nylon Paddle Scraper	02	6 ea
40353	48" Nylon Handle with 4.5" x 7.5" Nylon Paddle Scraper	00	6 ea
40354	48" Stainless Steel Handle with 4.5" x 7.5" Nylon Paddle Scraper	00	6 ea
40355	72" Stainless Steel Handle with 4.5" x 7.5" Nylon Paddle Scraper	00	6 ea
40356	48" Stainless Steel Handle with 6.5" x 9" Nylon Paddle Scraper	00	3 ea
40361	4.5" x 7" Standard Nylon Replacement Blade	02	6 ea
40362	6.5" x 9" Large Nylon Replacement Blade	00	6 ea

NSF Listed products are designated with a ▲ and may be prefixed with an N

## Sparta® Color-Coded Spatulas & Paddle Scrapers

- Spatulas are perfect for general mixing and stirring
- Standard Nylon (300°F) or soft flexible Polyethylene (150°F) blades will sharpen and contour to your specific application with usage
- Smooth finished, water-proof construction for easy clean-up
- Replacement blades are available for this product



40352C



40353C



40350C



403561C



Prod No	Description	Color	Pack
<b>Color-Coded Sparta Spatulas &amp; Paddle Scrapers</b>			
40350C	Sparta Scraper with Plastic Handle, 13.5" L	04, 05, 09, 14	6 ea
40352C	Sparta Paddle Scraper with Plastic Handle, 40" L	04, 05, 09, 14	6 ea
40353C	Sparta Paddle Scraper with Plastic Handle, 48" L	04, 05, 09, 14	6 ea
40361C	Sparta Standard Nylon Replacement Blade, 7.5" x 4.5" L	04, 05, 09, 14	6 ea



# TONGS, WHIPS & TOOLS

## Tongs

### Heavy-Duty Utility Tongs

- Heavy 20 gauge stainless steel with flat spring for long-lasting service
- Dishwasher safe

### Spectrum® Dura-Kool™ Tongs

- Color-coded Dura-Kool handles provide easy visual for zone isolation
- Single-piece, heavy-duty stainless construction eliminates food traps for more sanitary use
- Spring action hinge won't break, also provides convenient hook for storage

Carlisle's Spectrum System supports your HACCP program by promoting zone isolation and reducing the risk of cross-contamination with our complete offering of color-coded kitchen tools and cleaning accessories



## Sparta® Chef Series™ French Whips

- Sanitary fully-sealed construction eliminates bacteria harboring food traps
- Rust-free 18-8 stainless construction with heavy gauge spring wire loops
- Perfectly weighted and balanced for heavy mixing, stirring and beating batters, sauces and other thicker mixtures



Prod No	Description	Color	Pack
<b>Heavy-Duty Utility Tongs</b>			
607550	9.5" Heavy-Duty Utility Tongs	—	12 ea
607552	12" Heavy-Duty Utility Tongs	—	12 ea
607556	16" Heavy-Duty Utility Tongs	—	12 ea
<b>Spectrum Dura-Kool Tongs</b>			
607560 <span style="color: blue;">▲</span>	9.5" Spectrum Dura-Kool Tong	03, 04, 05, 09, 14	12 ea
607562 <span style="color: blue;">▲</span>	12" Spectrum Dura-Kool Tong	03, 04, 05, 09, 14	12 ea
607566 <span style="color: blue;">▲</span>	16" Spectrum Dura-Kool Tong	03, 05, 09, 14	12 ea
<b>Sparta Chef Series French Whips</b>			
40681	36" Chef Series Heavy-Weight French Whip	—	2 ea
40682	48" Chef Series Heavy-Weight French Whip	—	2 ea

NSF Listed products are designated with a ▲ and may be prefixed with an N

## High Heat Serving Spoons & Turner

- High heat material withstands temperatures from -40°F to 375°F without melting or transferring heat
- Helps prevent scratching on coated surfaces
- Notched handle with hole for hanging
- NSF Listed; dishwasher safe

### High Heat Serving Spoons

- Notched handle allows spoon to rest on edge of food pan



## Oil Bottle & Sprayer

- 16 oz capacity to keep oil fresh
- Amber color protects light sensitive oils
- Value alternative to aerosol cans of oil
- Pre-labeled to ensure segregation from cleaning bottles
- Thread is compatible with standard sprayers

### Sprayer (sold separately)

- Adjustable spray nozzle
- Metered application reduces food waste and improves consistency



## Sparta® Foodservice Shovels

- Heavy duty one-piece plastic construction
- Supports heavy loads, safe to use with food, will not rust and cleans up easily



Prod No	Description	Color	Pack
<b>High Heat Serving Spoons &amp; Turner</b>			
4415 $\Delta$	11" Solid High Heat Serving Spoon	03	12 ea
4416 $\Delta$	11" Perforated High Heat Serving Spoon	03	12 ea
4425 $\Delta$	13" Solid High Heat Serving Spoon	03	12 ea
4426 $\Delta$	13" Perforated High Heat Serving Spoon	03	12 ea
4900 $\Delta$	13" Slotted Turner	03, 13	12 ea
<b>Oil Bottle &amp; Sprayer</b>			
3816	16 oz Amber Bottle with Label	13	12 ea
3817	Trigger Sprayer	00	12 ea
<b>Sparta Foodservice Shovels</b>			
41076-1	11" Wide Foodservice Shovel	02	1 ea
41076	11" Wide Foodservice Shovel	02, 04, 05	6 ea
41077-1	14" Wide Foodservice Shovel	02	1 ea
41077	14" Wide Foodservice Shovel	02, 04, 05	6 ea

NSF Listed products are designated with a  $\Delta$  and may be prefixed with an N



**CARLISLE**  
FOODSERVICE PRODUCTS

20L — 22 qt.  
20L — 20 qt.  
15L — 16 qt.  
10L — 12 qt.  
10L — 10 qt.  
8 qt.

6L — 6 QT  
4L — 4 QT  
2L — 2 QT

1.5L — 2 QT  
1L — 1 QT  
3.5L — 4 QT  
3L — 3 QT  
2L — 2 QT  
1L — 1 QT



# TOUGH VERSATILE SAFE INNOVATIVE **STORAGE & HANDLING SUPPLIES**

---

*From distinct color-coding to easy-clean surfaces, Carlisle ensures that all of our products are designed to safely store, handle and transport food. You can count on Carlisle to help you keep food fresh, reduce food safety risks, reduce waste and operate efficiently*



# STORPLUS™

## COMPLETE STORAGE SOLUTIONS

Only Carlisle offers such a wide selection of storage containers for your foodservice operation.

All StorPlus products offer the quality construction and ease of use Carlisle is known for. They are tough and durable, plus these NSF Listed products are designed to support your HACCP program. Product features are detailed in this catalog section.



## Food Pans, Lids & Accessories

Polycarbonate and BPA-Free High Heat



### **Coldmaster®**

Innovative products that are a perfect compliment to your StorPlus containers

See pages 108-117 for a complete listing



### **EZ Access Lids**

Efficient and convenient flip hinge lid that keeps food safe

See pages 220-222 for a complete listing



### **Specialty Handled High Heat**

Help products stay warm and fresh for your customers

See page 223 for a complete listing





## Storage Boxes & Lids

Color-Coded For All Your Storage Needs



## Squares

Easy-To-Read Capacity Indicators  
Built-In Handles



## Rounds

Easy-To-Read Capacity Indicators  
Built-In Handles

## 3 Material Options

Carlisle Offers Three  
Food Pan Options

Polycarbonate, High Heat,  
Stainless Steel





# STORPLUS™ FOOD PANS

StorPlus is perfect for holding food day after day in all cold applications including buffets, cold wells, service line applications and fridge/freezer storage.

## Food Pans

- Smooth interior makes clean-up easy
- Reinforced corners prevent chips and cracks, stand up to drops and use day after day
- Universally stackable with all food pan products on the market
- Spoonable bottoms allow easy removal of contents and reduction of food waste
- Polycarbonate containers can withstand temperatures from -40°F to 212°F
- High-heat pans excel in high temperature applications and are BPA Free (-40°F to 375°F)
- Compatible with Carlisle StorPlus Universal Lids, Smart Lids, Drain Grates and EZ Access Lids
- Textured non-slip finish on corners, sides, bottom and lid reduce scratches
- Molded-in capacity indicators are listed in both quarts and liters
- NSF Certified; Made in the USA; Dishwasher Safe



## EZ Access Lids

- 50% to 60% larger opening improves hand and utensil access; reduces food waste
- Snug lid stays in place during routine opening; never flips off
- Clean design eliminates dangerous food traps found on other hinged lid designs
- The perfect solution for salad, cucumbers, buffets, prep stations and more
- Compliments Coldmaster and CoolCheck pans
- One-half and one-third sizes available with double notch for multiple portioning options
- Double-hinged design handles the abuse of the most demanding foodservice applications
- Convenient molded-in peg hole
- NSF Listed; dishwasher safe



## Universal Food Pan Lids

- Fit Carlisle StorPlus Food Pans as well as other major brands on the market
- Features a hanging hole for easy storage
- Fits both Gastronorm and standard size food pans
- Carlisle lids stack with themselves for easy storage
- Available in polycarbonate or high heat material
- NSF Listed; dishwasher safe





## Smart Lids™

- Unique inside seal design provides superior leak-resistance and keeps your foods fresher, longer
- Perfect for transporting foods to off site locations
- Smart Lids (combined with StorPlus Food Pans) fit inside Cateraide Top Loaders and End Loaders (shown on pages 171-177)
- Polyethylene material is dishwasher safe; for use in -40°F to 180°F
- Designed exclusively to fit StorPlus Food Pans



Smart Lid's unique inside seal design provides superior leak-resistance; protects against spills

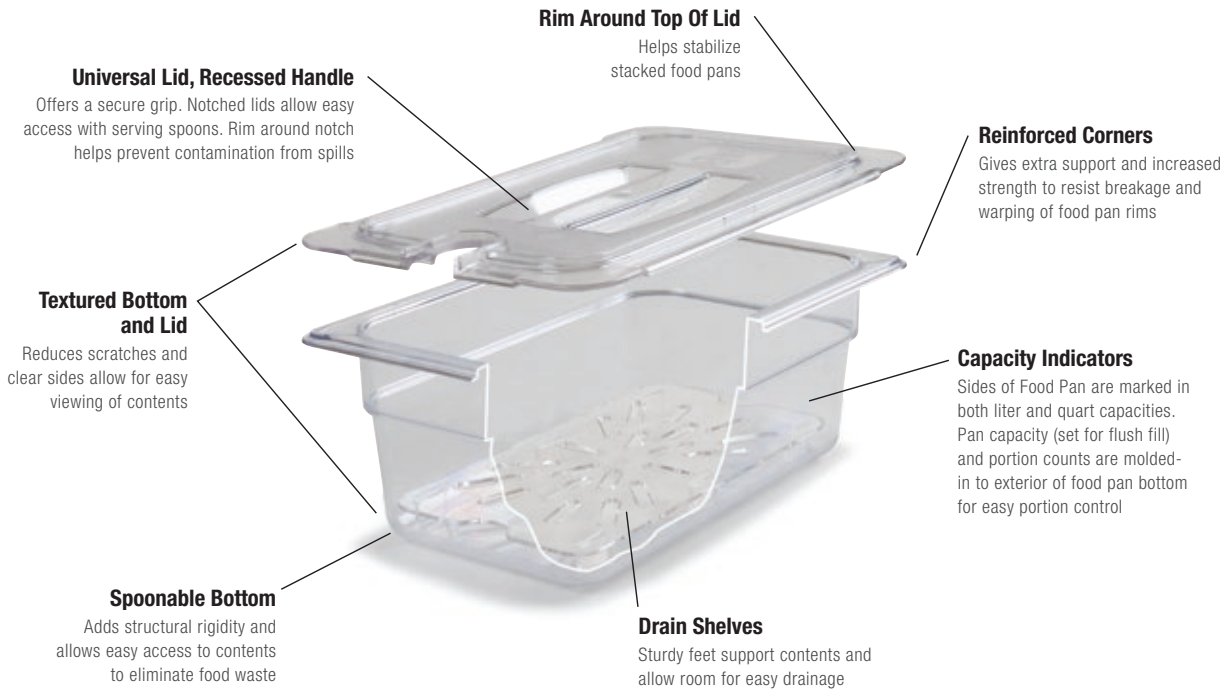

## Suggested Pan Layout

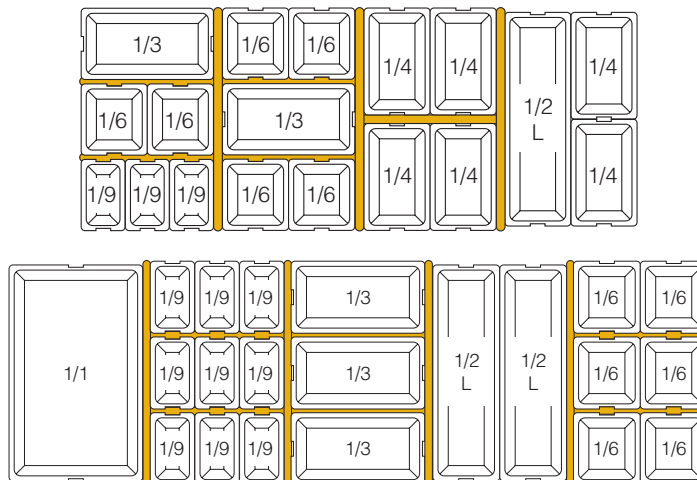



# STORPLUS™ FOOD PANS AND LIDS

## Polycarbonate Food Pans & Lids

- Smooth interior makes clean-up easy.
- Reinforced corners prevent chips and cracks, stand up to drops and use day after day
- Universally stackable with all food pan products on the market
- Spoonable bottoms allow easy removal of contents and reduction of food waste
- Polycarbonate containers can withstand temperatures from -40°F to 212°F
- Compatible with Carlisle StorPlus Universal Lids, Smart Lids, Drain Grates and EZ Access Lids
- Textured non-slip finish on corners, sides, bottom and lid reduce scratches
- Molded-in capacity indicators are listed in both quarts and liters
- NSF Certified; Made in the USA; Dishwasher Safe

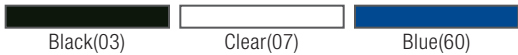

Prod No	Description	Color	Pack
<b>Full-Size – 20.75" x 12.75"</b>			
10200B Δ♦	Pan – 2.5" (7.6 qt)	03, 07	6 ea
10201B Δ♦	Pan – 4" (12.7 qt)	03, 07	6 ea
10202B Δ♦	Pan – 6" (19.4 qt)	03, 07	6 ea
10203B Δ♦	Pan – 8" (25.9 qt)	03, 07	6 ea
10215 Δ♦	Drain Shelf	07	6 ea
<b>Lids – Fits All Full-Size Pans</b>			
10212B	Smart Lid, Unnotched	60	6 ea
10210U Δ♦	Handled Lid, Unnotched	07	6 ea
10211U Δ♦	Handled Lid, Single Notched	07	6 ea
10216U Δ♦	Flat Lid, Unnotched	07	6 ea
10217U Δ♦	Flat Lid, Single Notched	07	6 ea
<b>One-Half Size – 12.75" x 10.38"</b>			
10220B Δ♦	Pan – 2.5" (3.6 qt)	03, 07	6 ea
10221B Δ♦	Pan – 4" (5.6 qt)	03, 07	6 ea
10222B* Δ♦	Pan – 6" (8.7 qt)	03, 07	6 ea
10223B Δ♦	Pan – 8" (11.4 qt)	07	6 ea
10235 Δ♦	Drain Shelf	07	6 ea

Prod No	Description	Color	Pack
<b>EZ Access Lids – One Half Size</b>			
10238Z Δ♦	Handled Lid, Unnotched	07	6 ea
10239Z Δ♦	Handled Lid, Single Notched	07	6 ea
10240Z Δ♦	Handled Lid, Double Notched	07	6 ea
<b>Lids – Fits All One-Half Size Pans</b>			
10232B	Smart Lid, Unnotched	60	6 ea
10230U Δ♦	Handled Lid, Unnotched	07	6 ea
10231U Δ♦	Handled Lid, Single Notched	07	6 ea
10236U Δ♦	Flat Lid, Unnotched	07	6 ea
<b>One-Half Long Size – 20.75" x 6.25"</b>			
10240B Δ♦	Pan – 2.5" (2.9 qt)	03, 07	6 ea
10241B Δ♦	Pan – 4" (5.1 qt)	03, 07	6 ea
<b>Lids – Fits All One-Half Long Size Pans</b>			
10250U Δ♦	Handled Lid, Unnotched	07	6 ea
10256U Δ♦	Flat Lid, Unnotched	07	6 ea

NSF Listed products are designated with a Δ and may be prefixed with an N  
 ♦ California Residents: Bisphenol A **WARNING:** See appendix A on page 1

## EZ Access Lids

- 50% to 60% larger opening improves hand and utensil access; reduces foodwaste
- Snug lid stays in place during routine opening; never flips off
- Clean design eliminates dangerous food traps found on other hinged lid designs
- The perfect solution for salad, cucumbers, buffets, prep stations and more
- Compliment your Coldmaster and CoolCheck pans
- One-half and one-third sizes available with double notch for multiple portioning options
- Double-hinged design handles the abuse of the most demanding foodservice applications
- Convenient molded-in peg hole
- NSF Listed; dishwasher safe

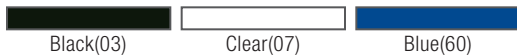

Prod No	Description	Color	Pack
<b>One-Third Size – 12.75" x 7"</b>			
30660 $\Delta$ ♦	Pan – 2.5" (2.4 qt)	03, 07	6 ea
30661 $\Delta$ ♦	Pan – 4" (3.8 qt)	03, 07	6 ea
30662 $\Delta$ ♦	Pan – 6" (5.7 qt)	03, 07	6 ea
30669 $\Delta$ ♦	Pan – 8" (7.3 qt)	03, 07	6 ea
30670 $\Delta$ ♦	Drain Shelf	07	6 ea
<b>EZ Access Lids – One Third Size</b>			
10278Z $\Delta$ ♦	Handled Lid, Unnotched	07	6 ea
10279Z $\Delta$ ♦	Handled Lid, Single Notched	07	6 ea
10280Z $\Delta$ ♦	Handled Lid, Double Notched	07	6 ea
<b>Lids – Fits All One-Third Size Pans</b>			
30580	Smart Lid, Unnotched	60	6 ea
10270U $\Delta$ ♦	Handled Lid, Unnotched	07	6 ea
10271U $\Delta$ ♦	Handled Lid, Single Notched	07	6 ea
10276U $\Delta$ ♦	Flat Lid, Unnotched	07	6 ea
10277U $\Delta$ ♦	Flat Lid, Single Notched	07	6 ea
<b>One-Quarter Size – 10.25" x 6.38"</b>			
30680 $\Delta$ ♦	Pan – 2.5" (1.7 qt)	03, 07	6 ea
30681 $\Delta$ ♦	Pan – 4" (2.8 qt)	03, 07	6 ea
30682 $\Delta$ ♦	Pan – 6" (4.0 qt)	03, 07	6 ea
30695 $\Delta$ ♦	Drain Shelf	07	6 ea
<b>Lids – Fits All One-Quarter Size Pans</b>			
30581	Smart Lid, Unnotched	60	6 ea
10290U $\Delta$ ♦	Handled Lid, Unnotched	07	6 ea
10291U $\Delta$ ♦	Handled Lid, Single Notched	07	6 ea
10296U $\Delta$ ♦	Flat Lid, Unnotched	07	6 ea
10297U $\Delta$ ♦	Flat Lid, Single Notched	07	6 ea



Prod No	Description	Color	Pack
<b>One-Sixth Size – 6.75" x 6.38"</b>			
30683 $\Delta$ ♦	Pan – 2.5" (1.1 qt)	03, 07	6 ea
30684 $\Delta$ ♦	Pan – 4" (1.7 qt)	03, 07	6 ea
30685 $\Delta$ ♦	Pan – 6" (2.5 qt)	03, 07	6 ea
30689 $\Delta$ ♦	Drain Shelf	07	6 ea
<b>EZ Access Lids – One Sixth Size</b>			
10318Z $\Delta$ ♦	Handled Lid, Unnotched	07	6 ea
10319Z $\Delta$ ♦	Handled Lid, Single Notched	07	6 ea
<b>Lids – Fits All One-Sixth Size Pans</b>			
30582	Smart Lid, Unnotched	60	6 ea
10310U $\Delta$ ♦	Handled Lid, Unnotched	07	6 ea
10311U $\Delta$ ♦	Handled Notched Lid	07	6 ea
10316U $\Delta$ ♦	Flat Lid, Unnotched	07	6 ea
10317U $\Delta$ ♦	Flat Lid, Single Notched	07	6 ea
<b>One-Ninth Size – 6.75" x 4.25"</b>			
30686 $\Delta$ ♦	Pan – 2.5" (0.7 qt)	03, 07	6 ea
30687 $\Delta$ ♦	Pan – 4" (1.0 qt)	03, 07	6 ea
30688 $\Delta$ ♦	Pan – 6" (1.4 qt)	03, 07	6 ea
10335 $\Delta$ ♦	Drain Shelf	07	6 ea
<b>EZ Access Lids – One Ninth Size</b>			
10338Z $\Delta$ ♦	Handled Lid, Unnotched	07	6 ea
10339Z $\Delta$ ♦	Handled Lid, Single Notched	07	6 ea
<b>Lids – Fits All One-Ninth Size Pans</b>			
30583	Smart Lid, Unnotched	60	6 ea
10336U $\Delta$ ♦	Flat Lid, Unnotched	07	6 ea
10337U $\Delta$ ♦	Flat Lid, Single Notched	07	6 ea

NSF Listed products are designated with a  $\Delta$  and may be prefixed with an N  
 ♦ California Residents: Bisphenol A **WARNING:** See appendix A on page 1



## High Heat Food Pans & Lids

- High heat pans excel in high temperature applications (-40°F to 375°F)
- For a leak-resistant seal use Smart Lids



Black(03)	Amber(13)	Blue(60)
-----------	-----------	----------

Prod No	Description	Color	Pack
<b>Full-Size – 20.75" x 12.75"</b>			
10400B $\Delta$	Pan – 2.5" (7.6 qt)	03, 13	6 ea
10401B $\Delta$	Pan – 4" (12.7 qt)	03, 13	6 ea
10402B $\Delta$	Pan – 6" (19.4 qt)	03, 13	6 ea
10415 $\Delta$	Drain Shelf	13	6 ea
<b>Lids – Fits All Full-Size Pans</b>			
10212B	Smart Lid, Unnotched	60	6 ea
10410U $\Delta$	Handled Lid, Unnotched	13	6 ea
10411U $\Delta$	Handled Lid, Single Notched	13	6 ea
10416U $\Delta$	Flat Lid, Unnotched	13	6 ea
10417U $\Delta$	Flat Notched Lid	13	6 ea
<b>One-Half Size – 12.75" x 10.38"</b>			
10420B $\Delta$	Pan – 2.5" (3.6 qt)	03, 13	6 ea
10421B $\Delta$	Pan – 4" (5.6 qt)	03, 13	6 ea
10422B $\Delta$	Pan – 6" (8.7 qt)	03, 13	6 ea
10423B $\Delta$	Pan – 8" (11.4 qt)	03, 13	6 ea
10435 $\Delta$	Drain Shelf	13	6 ea
<b>EZ Access Lids – One Half Size</b>			
10438Z $\Delta$	EZ Access Lid, Unnotched	13	6 ea
10439Z $\Delta$	EZ Access Lid, Single Notched	13	6 ea
10440Z	EZ Access Lid, Double Notched	13	6 ea
<b>Lids – Fits All One-Half Size Pans</b>			
10232B	Smart Lid, Unnotched	60	6 ea
10430U $\Delta$	Handled Lid, Unnotched	13	6 ea
10431U $\Delta$	Handled Lid, Single Notched	13	6 ea
10436U $\Delta$	Flat Lid, Unnotched	13	6 ea
10437U $\Delta$	Flat Lid, Single Notched	13	6 ea
<b>One-Half Long Size – 20.75" x 6.25"</b>			
10440B $\Delta$	Pan – 2.5" (2.9 qt)	03, 13	6 ea
10441B $\Delta$	Pan – 4" (5.1 qt)	03, 13*	6 ea
<b>Lids – Fits All One-Half Long Size Pans</b>			
10450U $\Delta$	Handled Lid, Unnotched	13	6 ea
<b>One-Third Size – 12.75" x 7"</b>			
30860 $\Delta$	Pan – 2.5" (2.4 qt)	03, 13	6 ea
30861 $\Delta$	Pan – 4" (3.8 qt)	03, 13	6 ea
30862 $\Delta$	Pan – 6" (5.7 qt)	03, 13	6 ea
30869 $\Delta$	Pan – 8" (7.3 qt)	03, 13	6 ea
30870 $\Delta$	Drain Shelf	13	6 ea
<b>EZ Access Lids – One Third Size</b>			
10478Z $\Delta$	EZ Access Lid, Unnotched	13	6 ea
10479Z $\Delta$	EZ Access Lid, Single Notched	13	6 ea
10480Z $\Delta$	EZ Access Lid, Double Notched	13	6 ea

Prod No	Description	Color	Pack
<b>Lids – Fits All One-Third Size Pans</b>			
30580	Smart Lid, Unnotched	60	6 ea
10470U $\Delta$	Handled Lid, Unnotched	13	6 ea
10471U $\Delta$	Handled Lid, Single Notched	13	6 ea
10476U $\Delta$	Flat Lid, Unnotched	13	6 ea
10477U $\Delta$	Flat Lid, Single Notched	13	6 ea
<b>One-Quarter Size – 10.25" x 6.38"</b>			
30880 $\Delta$	Pan – 2.5" (1.7 qt)	03, 13	6 ea
30881 $\Delta$	Pan – 4" (2.8 qt)	03, 13	6 ea
30882 $\Delta$	Pan – 6" (4.0 qt)	03, 13	6 ea
30895 $\Delta$	Drain Shelf	13	6 ea
<b>Lids – Fits All One-Quarter Size Pans</b>			
30581	Smart Lid, Unnotched	60	6 ea
10490U $\Delta$	Handled Lid, Unnotched	13	6 ea
10491U $\Delta$	Handled Lid, Single Notched	13	6 ea
10496U $\Delta$	Flat Lid, Unnotched	13	6 ea
<b>One-Sixth Size – 6.75" x 6.38"</b>			
30883 $\Delta$	Pan – 2.5" (1.1 qt)	03, 13	6 ea
30884 $\Delta$	Pan – 4" (1.7 qt)	03, 13	6 ea
30885 $\Delta$	Pan – 6" (2.5 qt)	03, 13	6 ea
30896 $\Delta$	Drain Shelf	13	6 ea
<b>EZ Access Lids – One Half Size</b>			
10518Z $\Delta$	EZ Access Lid, Unnotched	13	6 ea
10519Z $\Delta$	EZ Access Lid Notched	13	6 ea
<b>Lids – Fits All One-Sixth Size Pans</b>			
30582	Smart Lid, Unnotched	60	6 ea
10510U $\Delta$	Handled Lid, Unnotched	13	6 ea
10511U $\Delta$	Handled Lid, Single Notched	13	6 ea
10516U $\Delta$	Flat Lid, Unnotched	13	6 ea
<b>One-Ninth Size – 6.75" x 4.25"</b>			
30886 $\Delta$	Pan – 2.5" (0.7 qt)	03, 13	6 ea
30887 $\Delta$	Pan – 4" (1.0 qt)	03, 13	6 ea
30888 $\Delta$	Pan – 6" (1.4 qt)	03, 13	6 ea
10535 $\Delta$	Drain Shelf	13	6 ea
<b>EZ Access Lids – One Ninth Size</b>			
10538Z $\Delta$	EZ Access Lid, Unnotched	13	6 ea
10539Z $\Delta$	EZ Access Lid, Single Notched	13	6 ea
<b>Lids – Fits All One-Ninth Size Pans</b>			
30583	Smart Lid, Unnotched	60	6 ea
10536U $\Delta$	Flat Lid, Unnotched	13	6 ea
10537U $\Delta$	Flat Lid, Single Notched	13	6 ea

NSF Listed products are designated with a  $\Delta$  and may be prefixed with an N  
 Note: Capacities are based on liquid measurements to rim, i.e. flush fill



Made specifically for **warming and holding cabinets**, our single- and double-handled pans help **products stay warm and fresh for your customers.**

### Specialty High Heat Handled Pans

- Transports food safely from the oven to the warming unit
- Double handled pan is perfect for restaurants with “pass through” warming units
- Stain-, heat- and impact- resistant high heat material
- Available in 2.5" and 4" depths
- NSF Listed; dishwasher safe

### High Heat Pan Divider

Pair our high heat pan divider (30871) with our 1/3 size, 2.5" deep handled pans (30860HH and 308614) to warm and hold multiple items in one pan while reducing the risk of foods touching; perfect for low volume meat or chicken items

- Use with 1/6 size drain shelf to help keep foods fresh



Amber(13)

Prod No	Description	Color	Pack
<b>Specialty High Heat Pans</b>			
30860H $\Delta$	1/3 Size 2.5" Deep with 1 Handle	13	6 ea
30860HH $\Delta$	1/3 Size 2.5" Deep with 2 Handles	13	6 ea
30861H $\Delta$	1/3 Size 4" Deep with 1 Handle	13	6 ea
30861HH $\Delta$	1/3 Size 4" Deep with 2 Handles	13	6 ea
30871 $\Delta$	1/6 Size 2.5" Deep Pan Divider	13	8 ea

NSF Listed products are designated with a  $\Delta$  and may be prefixed with an N



# METAL FOOD PANS & LIDS

Food pans are **the back bone of any foodservice operation**. For storing, preparing and serving, they are a necessity. Only Carlisle offers you **complete versatility with a broad range of food pans** to meet your needs.



## DuraPan™ Food Pans

Double reinforced corners and unique impact resistant edge design help pans hold shape; will not jam together during storage. Tapered pans fit standard food pan templates and will stack or nest with most other leading brands. Versatile 18-8 stainless pans go from freezer to oven to serving line; ideal for cook-chill operations.

### Steam Table Application

DuraPan's impact resistant edge maintains shape better and lays flat, providing a tight seal for better temperature retention in steam tables

### DuraPan Covers

- Made of heavy gauge 18-8 stainless steel
- Available in solid or slotted styles
- Recessed handles offer a secure grip
- Notched lids allow easy access for serving spoons



### Coldmaster® Application

Use DuraPans with Coldmaster Coldpans (shown on page 113) to keep foods cold without ice or electricity



**Full Shoulders**  
Prevent jamming during storage and provide added strength for longer life

**Spoonable Bottoms**  
Add structural rigidity; allows easy access to food and makes clean up easier

**DuraPans Covers, Recessed Handles**  
Large, recessed handles offer a secure grip. Notched lids allow easy access with serving spoons

**Double Reinforced Corners**  
With unique impact resistant edge design holds shape even under the toughest conditions

## Drain Grates

- Chrome-plated, heavy-duty grates with durable welded construction holds food above pan
- Use for cooling or draining foods
- Fits full size pans



## Divided DuraPans

- Divided pan is perfect for serving complimentary foods
- Single pan fits in full size pan opening; eliminates the need for adapter bars



Divided Pan with PC140N Cateraide™ Top Loader

Available in heavy gauge or light gauge, Carlisle offers a wide range of accessories including solid and slotted covers, drain shelves, divided pans and adapter bars.

Prod No	Description	Pack
<b>Light Gauge</b>		
<b>Full-Size – 20.75" x 12.75"</b>		
607001 Δ	Pan – 1" (4.2 qt)	6 ea
607002 Δ	Pan – 2.5" (10.4 qt)	6 ea
607004 Δ	Pan – 4" (16.6 qt)	6 ea
607006 Δ	Pan – 6" (24.9 qt)	6 ea
607002P Δ	Perforated Pan – 2.5"	6 ea
607004P Δ	Perforated Pan – 4"	6 ea
607006P Δ	Perforated Pan – 6"	6 ea
607000C Δ	Solid Cover	6 ea
607000CS	Slotted Cover	6 ea
607000H	Hinged Flat Cover with Handles	6 ea
607002D Δ	Full-Size Divided Pan 2.5" Deep	6 ea
602202	Drain Grate - Fits Full-Size Food Pan	6 ea
<b>Two-Thirds Size – 13.88" x 12.75"</b>		
607232 Δ	Pan – 2.5" (6.8 qt)	6 ea
607236 Δ	Pan – 6" (16.2 qt)	6 ea
607230C Δ	Solid Cover	6 ea
<b>One-Half Size – 12.75" x 10.38"</b>		
607122 Δ	Pan – 2.5" (0.9 qt)	6 ea
607124 Δ	Pan – 4" (1.4 qt)	6 ea
607126 Δ	Pan – 6" (2.1 qt)	6 ea
607122P Δ	Perforated Pan – 2.5"	6 ea
607124P Δ	Perforated Pan – 4"	6 ea
607120C Δ	Solid Cover	6 ea
607120CS	Slotted Cover	6 ea
602203	Drain Grate - Fits Half-Size Food Pan	6 ea
<b>One-Half Long Size – 20.5" x 6.38"</b>		
60700HL2 Δ	Pan – 2.5" (5.2 qt)	6 ea
60700HL4 Δ	Pan – 4" (8.3 qt)	6 ea
60700HL6 Δ	Pan – 6" (12.5 qt)	6 ea
60700HLC Δ	Solid Cover	6 ea
<b>One-Third Size – 12.75" x 6.88"</b>		
607132 Δ	Pan – 2.5" (3.4 qt)	6 ea
607134 Δ	Pan – 4" (5.4 qt)	6 ea
607136 Δ	Pan – 6" (8.1 qt)	6 ea
607130C Δ	Solid Cover	6 ea
607130CS	Slotted Cover	6 ea
<b>One-Quarter Size – 10.38" x 6.38"</b>		
607142 Δ	Pan – 2.5" (2.6 qt)	6 ea
607144 Δ	Pan – 4" (4.2 qt)	6 ea
607146 Δ	Pan – 6" (6.2 qt)	6 ea
607140C Δ	Solid Cover	6 ea
607140CS	Slotted Cover	6 ea
<b>One-Sixth Size – 6.88" x 6.25"</b>		
607162 Δ	Pan – 2.5" (1.6 qt)	6 ea
607164 Δ	Pan – 4" (2.6 qt)	6 ea
607166 Δ	Pan – 6" (3.9 qt)	6 ea
607160C Δ	Solid Cover	6 ea
607160CS	Slotted Cover	6 ea
<b>One-Ninth Size – 6.88" x 4.25"</b>		
607192 Δ	Pan – 2.5" (1.0 qt)	6 ea
607194 Δ	Pan – 4" (1.7 qt)	6 ea
607190C Δ	Solid Cover	6 ea
607190CS	Slotted Cover	6 ea

Prod No	Description	Pack
<b>Heavy Gauge</b>		
<b>Full-Size – 20.75" x 12.75"</b>		
608002 Δ	Pan – 2.5" (10.4 qt)	6 ea
608004 Δ	Pan – 4" (16.6 qt)	6 ea
608006 Δ	Pan – 6" (24.9 qt)	6 ea
<b>Two-Thirds Size – 13.88" x 12.75"</b>		
608236 Δ	Pan – 6" (16.2 qt)	6 ea
<b>One-Half Size – 12.75" x 10.38"</b>		
608122 Δ	Pan – 2.5" (0.9 qt)	6 ea
608124 Δ	Pan – 4" (1.4 qt)	6 ea
608126 Δ	Pan – 6" (2.1 qt)	6 ea
<b>One-Third Size – 12.75" x 6.88"</b>		
608132 Δ	Pan – 2.5" (3.4 qt)	6 ea
608134 Δ	Pan – 4" (5.4 qt)	6 ea
608136 Δ	Pan – 6" (8.1 qt)	6 ea
<b>One-Quarter Size – 10.38" x 6.38"</b>		
608142 Δ	Pan – 2.5" (2.6 qt)	6 ea
608144 Δ	Pan – 4" (4.2 qt)	6 ea
608146 Δ	Pan – 6" (6.2 qt)	6 ea
<b>One-Sixth Size – 6.88" x 6.25"</b>		
608162 Δ	Pan – 2.5" (1.6 qt)	6 ea
608164 Δ	Pan – 4" (2.6 qt)	6 ea
608166 Δ	Pan – 6" (3.9 qt)	6 ea
<b>One-Ninth Size – 6.88" x 4.25"</b>		
608192 Δ	Pan – 2.5" (1.0 qt)	6 ea
608194 Δ	Pan – 4" (1.7 qt)	6 ea

### Adapter Bars

- Use adapter bars with in steam table applications, CATERAIDES or other standard transport containers
- Two sizes available to work with full or fractional size pans



Prod No	Description	Pack
<b>Adapter Bars</b>		
6070A Δ	20.5" Adapter Bar	12 ea
6071A Δ	12.75" Adapter Bar	12 ea

NSF Listed products are designated with a Δ and may be prefixed with an N  
 Note: Capacities are based on liquid measurements to rim, i.e. flush fill



# STORPLUS™ STORAGE BOXES

StorPlus **color-coded** storage boxes are a solution that helps employees **easily identify** proper storage containers, **eliminating cross-contamination**.

## Benefits of StorPlus Color-Coded Storage Boxes

- Prevent cross-contamination and help meet standards as part of a complete HACCP Program
- RimGlow™ technology gives the boxes and lids a distinct, yet transparent color to segregate them by usage

## StorPlus Color-Coded Storage Boxes & Lids

### Food Storage Boxes

- Reinforced top and bottom corners on both box and lid, help prevent chipping and cracking
- Quart, gallon and liter capacity indicators (on 12" x 18" box)
- StorPlus boxes stack easily for efficient storage, fit standard carts and racks and with other boxes on the market
- Smooth interior surface makes cleaning easy
- "Lock-Tight" lids can be reversed and used as bun pan or tray
- Polycarbonate boxes provide easy visibility, superior resistance to food acids and oils and withstands temperatures from -40°F to 212°F
- Boxes double as dough proofing bus boxes, warewashing tubs for kitchen overflow or remote locations
- 18" x 26" colander is ideal for storing, draining, thawing and marinating foods; keeps lettuce crisp, thaws and drains fish on ice, marinates chicken, etc.
- Polyethylene boxes offers economical storage and transport and withstands temperatures from -40°F to 180°F
- NSF Listed; dishwasher safe

### ServSafe® Recommended Stacking Order:



**Allergen Control**

**Cooked/Dry Foods and Dairy**

**Fruits/Vegetables**

**Meats**

**Fish/Seafood**

**Poultry**

ServSafe® is a registered trademark of the National Restaurant Association



White(02)	Red(05)	Clear(07)	Green(09)	Blue(14)	Yellow(22)	Purple(89)
Prod No	Color	Prod No	Color	Description	Pack	
<b>Clear Polycarbonate*</b>		<b>Color-Coded Polycarbonate</b>				
10610 Δ ♦	07			2 gal 12" x 18" x 3.5 Box	6 ea	
10611 Δ ♦	07	10611C Δ ♦	05, 09, 14, 22	3.5 gal 12" x 18" x 6" Box	6 ea	
10612 Δ ♦	07	10612C Δ ♦	05, 09, 14, 22	5 gal 12" x 18" x 9" Box	6 ea	
10617 Δ ♦	07	10617C Δ ♦	05, 09, 14, 22	12" x 18" Lid	6 ea	
10620 Δ ♦	07	—		5 gal 18" x 26" x 3.5" Box	6 ea	
10621 Δ ♦	07	10621C Δ ♦	05, 09, 14, 22, 89	8.5 gal 18" x 26" x 6" Box	6 ea	
10622 Δ ♦	07	10622C Δ ♦	05, 09, 14, 22, 89	12.5 gal 18" x 26" x 9" Box	4 ea	
10623 Δ ♦	07	10623C Δ ♦	05, 09, 14, 22	16.6 gal 18" x 26" x 12" Box	3 ea	
10624 Δ ♦	07	10624C Δ ♦	05, 09, 14, 22	21.5 gal 18" x 26" x 15" Box	3 ea	
10627 Δ ♦	07	10627C Δ ♦	05, 09, 14, 22, 89	18" x 26" Lid	6 ea	
10628 Δ ♦	07	—		18" x 26" x 5" Colander	6 ea	
10629 Δ ♦	07	—		18" x 26" Drain Grate	6 ea	

NSF Listed products are designated with a Δ and may be prefixed with an N  
Clear polycarbonate food boxes comes in Clear(07) only

♦ California Residents: Bisphenol A **WARNING:** See appendix A on page 1



White(02)

Prod No	Description	Color	Pack
<b>White Polyethylene</b>			
10630 Δ	2 gal 12" x 18" x 3.5" Box	02	6 ea
10631 Δ	3.5 gal 12" x 18" x 6" Box	02	6 ea
10632 Δ	5 gal 12" x 18" x 9" Box	02	6 ea
10637 Δ	12" x 18" "Lock-Tight" Lid	02	6 ea
10640 Δ	5 gal 18" x 26" x 3.5" Box	02	6 ea
10641 Δ	8.5 gal 18" x 26" x 6" Box	02	6 ea
10642 Δ	12.5 gal 18" x 26" x 9" Box	02	4 ea
10643 Δ	16.6 gal 18" x 26" x 12" Box	02	3 ea
10644 Δ	21.5 gal 18" x 26" x 15" Box	02	3 ea
10647 Δ	18" x 26" "Lock-Tight" Lid	02	6 ea
10648 Δ	18" x 26" x 5" Colander	02	6 ea

NSF Listed products are designated with a Δ and may be prefixed with an N



# STORPLUS™ STORAGE CONTAINERS

StorPlus storage containers are clear and have **tight fitting lids**, improving organization and **minimizing the risk** of cross contamination, **making work easier**.

## Square Food Storage Containers

- Perfect for storing condiments, spices, toppings, leftover or preparation
- Stacking lugs add rigidity and eliminate jamming
- Stackable with other popular brands; compatible lids fit competitors' food storage containers
- Wide handles and drain holes available on all sizes for easy-grip and quick drying
- Writing surface available to record dates and reduce food waste
- Color-coded, textured snap-on lids fit both the polycarbonate and polyethylene containers
- Smooth interior finish with spoonable bottom helps prevent food waste and makes clean-up easy
- Clear polycarbonate containers provide exceptional durability and can withstand temperatures from -40°F to 212°F
- Economical white polyethylene containers withstand temperatures from -40°F to 180°F
- NSF Listed; dishwasher safe



### Safe & Easy Lifting

Carlisle offers square storage containers in 2qt to 22qt with handles on both sides

### Cross Compatible

Carlisle StorPlus lids fit and stack with key competitors' food storage containers

White(02)	Red(05)	Clear(07)	Forest Green(08)	Blue(60)	Purple(89)	Purple(AF07)
-----------	---------	-----------	------------------	----------	------------	--------------

Prod No	Description	Color	Pack
<b>StorPlus Square Polycarbonate Food Storage Containers</b>			
10720 $\Delta$ ♦	2 qt, 7.13" Sq x 3.81" H Polycarbonate Container	07, AF07	6 ea
10721 $\Delta$ ♦	4 qt, 7.13" Sq x 7.31" H Polycarbonate Container	07, AF07	6 ea
10722 $\Delta$ ♦	6 qt, 8.75" Sq x 7.31" H Polycarbonate Container	07, AF07	6 ea
10723 $\Delta$ ♦	8 qt, 8.75" Sq x 9" H Polycarbonate Container	07, AF07	6 ea
10724 $\Delta$ ♦	12 qt, 11.13" Sq x 8.25" H Polycarbonate Container	07, AF07	6 ea
10725 $\Delta$ ♦	18 qt, 11.13" Sq x 12.56" H Polycarbonate Container	07, AF07	6 ea
10726 $\Delta$ ♦	22 qt, 11.13" Sq x 15.75" H Polycarbonate Container	07, AF07	6 ea
<b>StorPlus Square Polyethylene Food Storage Containers</b>			
10730 $\Delta$	2 qt, 7.13" Sq x 3.81" H Polyethylene Container	02	6 ea
10731 $\Delta$	4 qt, 7.13" Sq x 7.31" H Polyethylene Container	02	6 ea
10732 $\Delta$	6 qt, 8.75" Sq x 7.31" H Polyethylene Container	02	6 ea
10733 $\Delta$	8 qt, 8.75" Sq x 9" H Polyethylene Container	02	6 ea
10734 $\Delta$	12 qt, 11.13" Sq x 8.25" H Polyethylene Container	02	6 ea
10735 $\Delta$	18 qt, 11.13" Sq x 12.56" H Polyethylene Container	02	6 ea
10736 $\Delta$	22 qt, 11.13" Sq x 15.75" H Polyethylene Container	02	6 ea
<b>StorPlus Square Container Lids</b>			
10740 $\Delta$	2-4 qt, 7.31" Sq Lid	08, 89	6 ea
10741 $\Delta$	6-8 qt, 9" Sq Lid	05, 89	6 ea
10742 $\Delta$	12-18-22 qt, 11.38" Sq Lid	60, 89	6 ea

NSF Listed products are designated with a  $\Delta$  and may be prefixed with an N  
 ♦ California Residents: Bisphenol A **WARNING:** See appendix A on page 1



**Textured Lids**  
Non-slip texturing provides secure stacking and scratch resistance. Snap-on lid fits both polycarbonate and polyethylene containers

**Wide, Easy Grip Handles**  
All sizes have a wide, comfortable handle design with textured finish to provide a secure grip

**Date Indicators**  
On all four sides help maintain food quality and make inventory control easy

**Spoonable Bottoms**  
Makes removal of contents easier, helps prevent food waste and promotes easy clean-up

**Contents & Date Indicators**  
Provides convenient space for marking contents and date to help promote product freshness and quality

**Stacking Lugs**  
Corner stacking lugs add strength, rigidity and prevent jamming when stacked. Containers stack with other popular brands

**Capacity Indicators**  
Listed in both gallons and liters, are color-coded to match lids for quick identification

**Textured Finish**  
Non-slip textured finish on corners, edges and bottom of container reduces scratches to keep containers looking like new longer



Prod No	Description	Color - Container/Lid	Pack
<b>StorPlus 3-Pack Square Containers (Includes Lids)</b>			
10720-307 $\Delta$ $\blacklozenge$	2 qt, 7.13" Sq x 3.81" H Polycarbonate Container	07 / 08	3 ea
10721-307 $\Delta$ $\blacklozenge$	4 qt, 7.13" Sq x 7.31" H Polycarbonate Container	07 / 08	3 ea
10730-302 $\Delta$	2 qt, 7.13" Sq x 3.81" H Polyethylene Container	02 / 08	3 ea
10731-302 $\Delta$	4 qt, 7.13" Sq x 7.31" H Polyethylene Container	02 / 08	3 ea
<b>StorPlus 2-Pack Square Containers (Includes Lids)</b>			
10722-207 $\Delta$ $\blacklozenge$	6 qt, 8.75" Sq x 7.31" H Polycarbonate Container	07 / 05	2 ea
10723-207 $\Delta$ $\blacklozenge$	8 qt, 8.75" Sq x 9" H Polycarbonate Container	07 / 05	2 ea
10732-202 $\Delta$	6 qt, 8.75" Sq x 7.31" H Polyethylene Container	02 / 05	2 ea
10733-202 $\Delta$	8 qt, 8.75" Sq x 9" H Polyethylene Container	02 / 05	2 ea

NSF Listed products are designated with a  $\Delta$  and may be prefixed with an N  
 $\blacklozenge$  California Residents: Bisphenol A **WARNING:** See appendix A on page 1



# STORPLUS™ STORAGE CONTAINERS

## Economical Space Savers

- Clean, safe alternative to storing food in shipping cartons
- Square shape allows for practical storage in the freezer, cooler or shelf
- Molded-in volume graduations indicate capacity
- Translucent polypropylene offers contact clarity for easy identification of products
- Withstand temperatures from 32°F to 170°F
- Economical white polyethylene withstands temperatures from -40°F to 180°F
- NSF Listed; dishwasher safe



Prod No	Description	Color	Pack
<b>Economical Polypropylene Space Savers</b>			
ST1532 $\Delta$	2 qt, 6.62" Sq x 4.12" H Polypropylene Container	30	12 ea
ST1544 $\Delta$	4 qt, 6.62" Sq x 8.12" H Polypropylene Container	30	12 ea
ST1556 $\Delta$	6 qt, 8.60" Sq x 6.87" H Polypropylene Container	30	12 ea
ST1568 $\Delta$	8 qt, 8.60" Sq x 9.25" H Polypropylene Container	30	12 ea
ST1629 $\Delta$	18 qt, 14.18" x 8.31" x 12.75" H Polypropylene Container	30	6 ea
<b>Economical Polyethylene Space Savers</b>			
1532 $\Delta$	2 qt, 6.62" Sq x 4.12" H Polyethylene Container	02	12 ea
1544 $\Delta$	4 qt, 6.62" Sq x 8.12" H Polyethylene Container	02	12 ea
1556 $\Delta$	6 qt, 8.60" Sq x 8.12" H Polyethylene Container	02	12 ea
1568 $\Delta$	8 qt, 8.60" Sq x 9.25" H Polyethylene Container	02	12 ea
1629 $\Delta$	18 qt, 14.18" x 8.31" x 12.75" H Polyethylene Container	02	6 ea
<b>Economical Space Saver Lids</b>			
ST1573	2-4 qt, 6.62" Sq Lid	30	12 ea
ST1587	6-8 qt, 8.60" Sq Lid	30	12 ea
ST1630	18 qt, 14.37" Sq Lid	30	6 ea

NSF Listed products are designated with a  $\Delta$  and may be prefixed with an N





## Round Food Storage Containers

- Super-tough, clear polycarbonate for ultimate durability allows easy food content identification at a glance
- StorPlus containers stack with other major brands for convenient storage; stacking shoulder prevents jamming
- Date indicator helps maintain food quality and control inventory turns, interchangeable with other brands
- Exclusive Carlisle spoonable bottom for increased yield and less food waste
- Clear polycarbonate containers can withstand temperatures from -40°F to 212°F
- NSF Listed; dishwasher safe



Prod No	Description	Color	Pack
<b>StorPlus Round Food Storage Containers</b>			
10761 $\Delta$ ♦	1 qt Round Container	07	12 ea
10763 $\Delta$ ♦	2 qt Round Container	07	12 ea
10764 $\Delta$ ♦	4 qt Round Container	07	12 ea
10765 $\Delta$ ♦	6 qt Round Container	07	12 ea
10766 $\Delta$ ♦	8 qt Round Container	07	12 ea
10767 $\Delta$ ♦	12 qt Round Container	07	6 ea
10768 $\Delta$ ♦	18 qt Round Container	07	6 ea
10769 $\Delta$ ♦	22 qt Round Container	07	6 ea
<b>StorPlus Round Container Lids</b>			
10770 $\Delta$ ♦	1 qt Round Lid	30	12 ea
10771 $\Delta$ ♦	2-4 qt Round Lid	08	12 ea
10772 $\Delta$ ♦	6-8 qt Round Lid	05	12 ea
10773 $\Delta$ ♦	12-18-22 qt Round Lid	60	6 ea

NSF Listed products are designated with a  $\Delta$  and may be prefixed with an N  
 ♦ California Residents: Bisphenol A **WARNING:** See appendix A on page 1



# STORPLUS™ STORAGE CONTAINERS

## Bains Marie

- Carlisle Bains Marie are the original round food storage containers
- Outside stacking lugs prevent jamming
- 12, 18, & 22 qt sizes have recessed handles for extra strength and stability in lifting, as well as graduated U.S. measurements shown on the side of the container
- 2, 3.5, 6, & 8 qt sizes can be imprinted
- Clear polypropylene containers are translucent and seamless, offering contact clarity for easy identification of products
- Polypropylene containers withstand temperatures from 32°F to 170°F
- Economical white polyethylene containers will withstand temperatures from -40°F to 180°F
- NSF Listed; dishwasher safe



Prod No	Description	Color	Pack
<b>Bains Marie Polypropylene Containers</b>			
0205 Δ	2 qt Container, 6.56" D x 4.38" H	30	12 ea
0355 Δ	3.5 qt Container, 6.56" D x 7.63" H	30	12 ea
0605 Δ	6 qt Container, 7.63" D x 8.13" H	30	12 ea
0805 Δ	8 qt Container, 7.63" D x 10.75" H	30	12 ea
1205 Δ	12 qt Container, 12.25" D x 8.75" H	30	6 ea
1805 Δ	18 qt Container, 12.38" D x 13" H	30	6 ea
2205 Δ	22 qt Container, 12.25" D x 15.44" H	30	6 ea
<b>Bains Marie Polypropylene Container Lids</b>			
0202 Δ	2 – 3.5 qt Lid, 6.69" D x .31" H	30	12 ea
0602 Δ	6 – 8 qt Lid, 8.06" D x .38" H	30	12 ea
1252 Δ	12 – 18 – 22 qt Lid, 12.38" D x .75" H	30	6 ea
<b>Bains Marie Polyethylene Containers</b>			
0200 Δ	2 qt Container, 6.56" D x 4.44" H	02	12 ea
0350 Δ	3.5 qt Container, 6.56" D x 7.63" H	02	12 ea
0600 Δ	6 qt Container, 7.63" D x 8.13" H	02	12 ea
0800 Δ	8 qt Container, 7.625" D x 10.75" H	02	12 ea
1200 Δ	12 qt Container, 12.25" D x 8.75" H	02	6 ea
1800 Δ	18 qt Container, 12.38" D x 13" H	02	6 ea
2200 Δ	22 qt Container, 12.25" D x 15.44" H	02	6 ea
<b>Bains Marie Polyethylene Container Lids</b>			
0203 Δ	2 – 3.5 qt Lid, 6.69" D	02	12 ea
0603 Δ	6 – 8 qt Lid, 8.63" D	02	12 ea
1202 Δ	12 – 18 – 22 qt Lid, 12.38" D	02	6 ea

NSF Listed products are designated with a Δ and may be prefixed with an N



### Ingredient Bins

- Portable, convenient storage bins for large quantities of sugar, flour, etc.
- Lids slide open for easy access
- Heavy-duty, non-marking casters
- Replacement Parts for BIN27, BIN36, & BIN44 shown in chart below



### Floor Rack System

- Interlocking modular system provides a raised surface in dry and cooling storage areas
- Perfect for areas where moisture collects on the floor
- Open design allows for air circulation
- 12" square units lock together, holds up to 3,000 pounds per square foot
- Made of FDA approved high density polyethylene, withstands temperatures from -40°F to 180°F
- NSF Listed; dishwasher safe or clean with hose



Prod No	Description	Color	Pack
<b>Ingredient Bins</b>			
BIN27	27 gal Capacity Bin, 28.5"L x 12.69"W x 27.88"H	02	1 ea
BIN36	36 gal Capacity Bin, 29.5"L x 15.38"W x 28.25"H	02	1 ea
BIN44	44 gal Capacity Bin, 29.5"L x 18.13"W x 29"H	02	1 ea
BIN27L	Replacement lid for BIN27	02	1 ea
BIN36L	Replacement lid for BIN36	02	1 ea
BIN44L	Replacement lid for BIN44	02	1 ea
<b>Floor Rack</b>			
2710 $\Delta$	12" x 12" x 1.5" Floor Rack	23	12 ea

NSF Listed products are designated with a  $\Delta$  and may be prefixed with an N



**CARLISLE**  
FOODSERVICE PRODUCTS

EFFICIENT  
DURABLE  
INNOVATIVE  
SMART  
**WARE-  
WASHING  
PRODUCTS**

---

*Carlisle offers every rack, basket and accessory you need for efficient warewashing operations. OptiClean™ is the industry standard for enabling clean, spotless ware. Our full line of color-coded rack extenders and Plaque-a-Racks are the ideal solution for sorting and managing your ware.*





# OPTICLEAN™

## Engineered to Flow

Warewashing can be labor intensive. If not well managed, it is likely to hurt your operation's bottom line and add unnecessary frustration. However, labor and efficiency is not the operator's only problem. The quality of your warewashing could directly affect your customers' health and the reputation of your establishment. If an effective system of cleaning and sanitation is not upheld, you may be facing risks on a daily basis that could jeopardize the future of your business.



### 3-Component System

Base Rack // Open Extender // Divided Extender

By alternating open and divided extenders, each level of the rack offers efficient flow through of water for superior performance and thick divided walls for protection



### Double-wall Construction

Maximum strength, protects contents from moving machine parts



### Versatile Stacking

Stacking from either direction and with all major competitors



### Open Wall Design

Open profile facilitates superior washing, complete rinsing and fast drying



### Quick Draining

No flat surfaces to trap water or loose food particles within the rack—ensuring rapid drying



### 4-way Tracking

Easy dish machine loading from any side without the need to rotate racks



### Locking Extenders

Unique snap-on design allows for fast, simple assembly



### Comfort Curve Handles

Comfort Curve Handles—molded into all four sides for easy handling, won't pinch fingers

All OptiClean Racks have an outside measurement of 19.75" x 19.75"

## The Honeycomb

We've developed the most highly engineered warewashing solutions to improve your establishment's operational efficiency. Carlisle utilizes a tested geometric honeycomb structure, admired and studied since ancient times. The honeycomb design delivers unmatched durability while simultaneously increasing the flow of water through each rack. The open honeycomb design also eliminates flat surfaces and corners that would otherwise harbor food particles allowing water to drain and contents to dry quickly.

## NeWave™

In pursuit of an even more efficient foodservice operation, we developed the OptiClean NeWave glass rack. These rounded wave design racks hold 20% more glasses than equivalent, square-compartment racks. This means more glasses in less racks, reduced chemical and/or water usage and improved labor efficiency. NeWave also holds glasses securely in place, resulting in minimal movement and reduced breakage.

## Easy Identification

Water is not the only aspect we engineered to flow. A color-coded system allows operators to choose their own method of identification to categorize by the type of glass, location of wares within the facility or even specific types of events. This color-coded system allows your operation to flow smoothly and eliminate unnecessary confusion for both existing and new employees.



### Textured Finish

Non-slip textured finish on outside walls reduces scratches to keep racks looking new, improve durability and provide a secure grip



### 6 Extender Colors



### NSF Listed

## How To Create The Correct Item Number For Your Washrack

**1** Each item begins with an **R** for rack

**2** Second digit indicates type

- G // Glass
- W // NeWave
- C // Cup
- P // Peg/Plate\*
- B // Bowl\*
- F // Flatware\*
- SP // Sheet Pan\*
- FP // Food Pan\*
- PC // Plate Cover\*
- TP // Tall Peg\*
- OP // Open Peg\*

\*Skip to Step Six

Only available in Blue(14)

**3** Glass, NeWave (only 20 or 30) & Cup (only 16 or 20) racks have additional digits beginning with number of compartments

- 9 // Nine Compartment
- 16 // Sixteen Compartment
- 20 // Twenty Compartment
- 25** // Twenty-five Compartment
- 30 // Thirty Compartment
- 36 // Thirty-six Compartment
- 49 // Forty-nine Compartment

**4** To add extenders, add a dash and the # of extenders\*

- 1 // One Extender
- 2 // Two Extenders
- 3** // Three Extenders
- 4 // Four Extenders
- 5 // Five Extenders

\* RW racks have a standard integrated extender, therefore an additional extender for each line listed above e.g. RW20-1 includes two extenders.

**5** If you want color-coded extenders, add a **C** – Otherwise, skip this step

**6** Lastly, add the color-code

- 410** // Red/Blue
- 411 // Yellow/Blue
- 412 // Orange/Blue
- 413 // Green/Blue
- 414 // Lavender/Blue
- 14 // Blue

**7** This order is for a glass rack with 25 compartments, 3 extenders and the top extender is red.

**RG25-3C410**

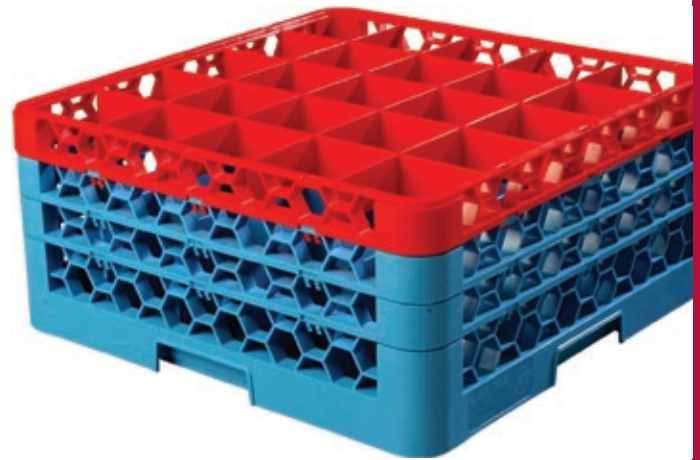

### Extender Heights

No Extender	3-1/8"
1 Extender	4-5/8"
2 Extenders	6-1/8"
3 Extenders	7-5/8"
4 Extenders	9-1/8"
5 Extenders	10-5/8"

- Extenders are available in multiple colors including Blue(14), Yellow(04), Red(05), Green(09), Orange(24), Lavender(89)
- Additional accessories can be found at the web address below

### Washrack Sizing

Rack #	Description	Min Dia	Max Dia	Min Dia	Max Dia	Dia for Handles
<b>Standard</b>						
RG49	49 Compartment Glass Rack	2"	2-3/8"	51 mm	60 mm	2-7/8"
RG36	36 Compartment Glass Rack	2-3/8"	2-3/4"	60 mm	70 mm	3-5/8"
RG25	25 Compartment Glass Rack	2-3/4"	3-3/8"	70 mm	86 mm	4-3/8"
RG16	16 Compartment Glass Rack	3-3/8"	4-3/8"	86 mm	111 mm	5-5/8"
RG9	9 Compartment Glass Rack	4-3/8"	5-7/8"	111 mm	149 mm	7-3/4"
<b>NeWave</b>						
RW30	Glass Rack w/ Integrated Extender 30 Compartment	2-5/8"	3"	67 mm	76 mm	
RW20	Glass Rack w/ Integrated Extender 20 Compartment	3"	3-3/4"	76 mm	95 mm	
<b>Tilted Cup</b>						
RC20	Tilted Cup Rack 20 Compartment	2-5/8"	4-1/4"	67 mm	108 mm	5-1/8"
RC16	Tilted Cup Rack 16 Compartment	4-1/4"	4-3/8"	108 mm	111 mm	6-5/8"

Find The Perfect Glass Rack  
[www.carlislefsp.com/FINDRACK](http://www.carlislefsp.com/FINDRACK)



# NEW Customization

## Hot Stamping

### MOQ

150 eaches per customized rack  
*(must divide into case pack quantities)*

### Lead Time

3-4 weeks from receiving PO

### Pricing

All pricing is calculated on net customer pricing plus a per piece charge

Per piece charge for hot stamp is net \$0.75/side

### Set Up Charge

\$80 per stamp design

*Only 3 sides available for inserts for NSF rated products*

### Artwork for hot stamp:

Digital artwork is required for all custom warewash products. Camera-ready art is defined as digital files in vector format. The preferred format includes Illustrator, Illustrator EPS or InDesign. PNG files (with a transparent background) may be submitted but must be a minimum of 300dpi at 100% of reproduction size. Decorating is limited to one color. Black or white imprint is standard stocked colors, contact Customer Service for a complete list of available imprint colors.

### Size dimensions of artwork

3.5" x 1" tall

### Sample

Digital sample to be provided

Inserts or stamps will be ordered with signed and approved artwork

Lead time for digital sample: 1-2 days (after receiving sufficient logo file)

### No Returns





# NEW Customization

## Color-Coded Base Racks

### MOQ

300 eaches per customized rack  
*(must divide into case pack quantities)*

### Lead Time

3-4 weeks from receiving PO

### Pricing

All pricing is calculated on net customer pricing plus a per piece charge

Per piece charge for custom colors is net \$1.30/rack

### Colors Available

-  Red
-  Yellow
-  Orange
-  Green
-  Purple

### Base Racks Available

RW20	RG16	RP	RC16
RW30	RG25	RTP	RC20
RG9	RG36	RB	
	RG49	RF	

### No Returns

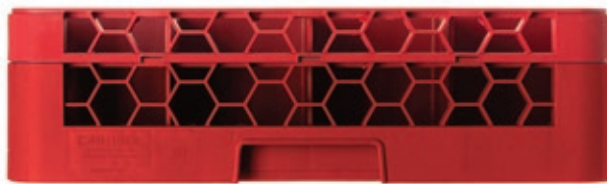

## Inserts

### MOQ

150 eaches per customized rack  
*(must divide into case pack quantities)*

### Lead Time

3-4 weeks from receiving PO

### Pricing

All pricing is calculated on net customer pricing plus a per piece charge

Per piece charge for custom insert is net \$0.40/side

### Set Up Charge

Inserts - \$1,000/side

*Only 3 sides available for inserts for NSF rated products*

### Artwork for inserts:

Digital artwork is required for all custom warewash products. Camera-ready art is defined as digital files in vector format. The preferred format includes Illustrator, Illustrator EPS or InDesign. PNG files (with a transparent background) may be submitted but must be a minimum of 300dpi at 100% of reproduction size.

### Size dimensions of artwork

3.5" x 1" tall

### No Returns





# OPTICLEAN®

## Color-Coded Glass Racks

- OptiClean Glass Racks with Color-Coded Extenders make it easy to identify glass rack size or match specific glassware with a specific rack simply by color
- Carlisle's OptiClean system includes a full range of glass racks designed to meet your needs
- Full dividers in the base offer complete protection for delicate rims
- NSF Listed



### Available Colors & Combinations

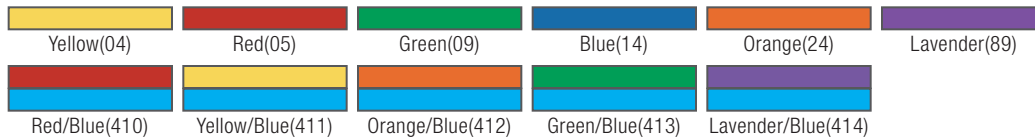

### New Color-Coded Options

#### Engineered to Flow

If your operation has multiple drinkware styles that need to be washed, stored and easily identified, Carlisle has a solution to make work easier. Our OptiClean extenders are available in six color choices. Use this option to color-code your glass racks and keep each piece of drinkware in its proper place. If you have multiple areas of serving within your establishment you can designate specific colors so that your fine dining stemware stays separate from the poolside drinkware.

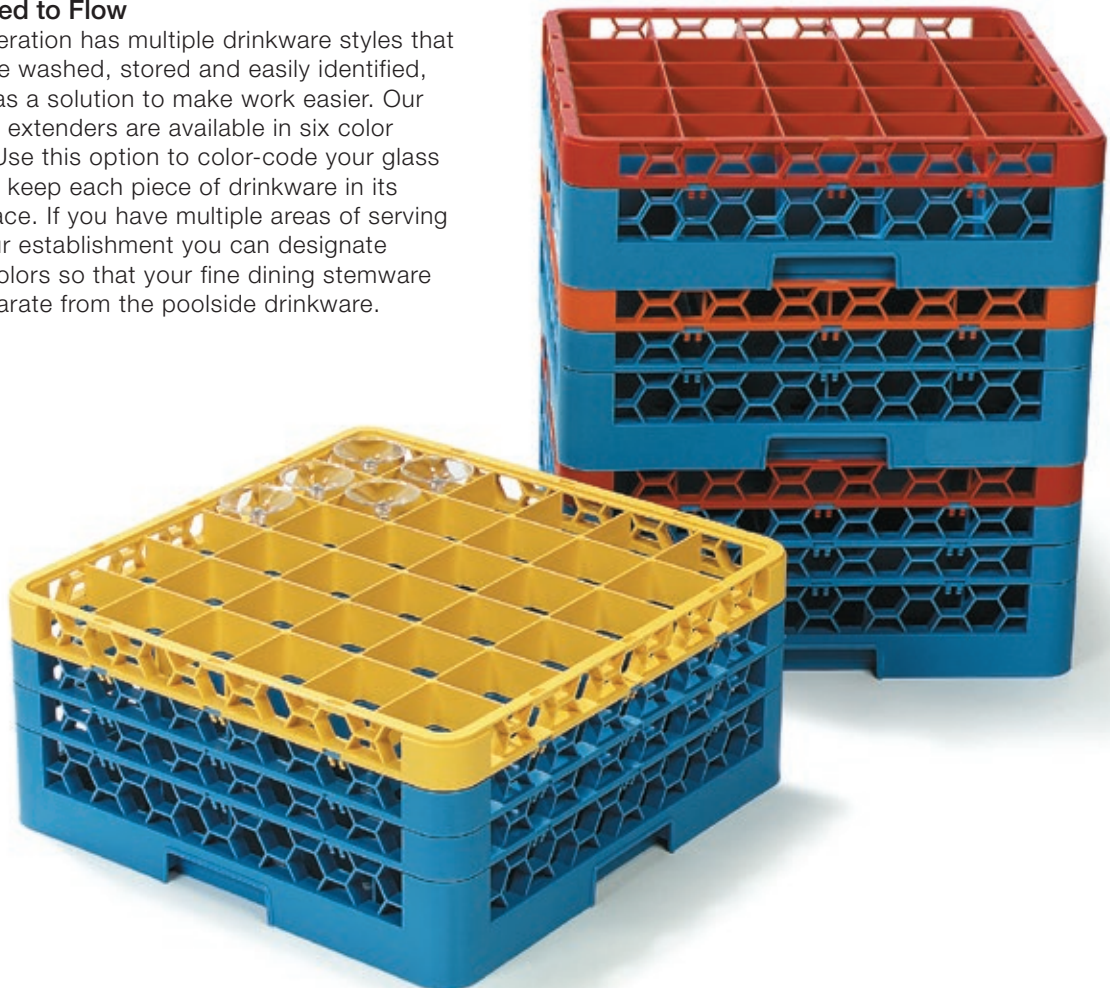

## OptiClean NeWave Color-Coded Glass Racks

- Fits 25% more glasses which saves on chemical cost by washing more glasses per cycle
- Honeycomb design allows a free flow of soap and water and balanced weight dispersion when racks are stacked high
- Compatible stacking with standard dish racks ensuring a smooth transition to Carlisle washracks without interrupting workflow
- Color coded extenders allow for convenient identification
- Most durable rack in the market
- NSF Listed



### NeWave 20-Compartment

- Use for glasses & tumblers

### NeWave 30-Compartment

- Use for glasses & tumblers

Get more clean glasses per wash cycle. Check out the measurement chart on page 237 to find the most efficient wash rack for your glass size.



RW20



RW30-2

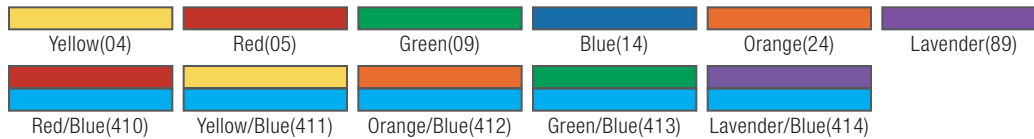

Prod No	Description	Glass Dia*	Glass Height	Color	Pack
<b>20-Compartment NeWave Glass Rack - Compartment Size 3.81" Dia</b>					
RW20 $\Delta$	20-Compartment with Integrated Extender	3.56"	4.75"	14	4 ea
RW20-1 $\Delta$	20-Compartment with 2 Extenders	3.56"	6.34"	14	3 ea
RW20-2 $\Delta$	20-Compartment with 3 Extenders	3.56"	7.94"	14	2 ea
RW20-3 $\Delta$	20-Compartment with 4 Extenders	3.56"	9.5"	14	2 ea
REW20S	20-Compartment Extender	3.56"	1.5"	14	6 ea
<b>20-Compartment Color-Coded NeWave Glass Rack—Compartment Size 3.81" Dia</b>					
REW20SC	20-Compartment Divided Extender	3.56"	1.5"	04, 05, 09, 24, 89	6 ea
RW20-C $\Delta$	20-Compartment with Integrated Extender	3.56"	4.75"	410, 411, 412, 413, 414	4 ea
RW20-1C $\Delta$	20-Compartment with 2 Extenders	3.56"	6.34"	410, 411, 412, 413, 414	3 ea
RW20-2C $\Delta$	20-Compartment with 3 Extenders	3.56"	7.94"	410, 411, 412, 413, 414	2 ea
RW20-3C $\Delta$	20-Compartment with 4 Extenders	3.56"	9.5"	410, 411, 412, 413, 414	2 ea
RW20-4C $\Delta$	20-Compartment with 5 Extenders	3.56"	11.1"	410, 411, 412, 413, 414	1 ea
<b>30-Compartment NeWave Glass Rack - Compartment Size 3.13" Dia</b>					
RW30 $\Delta$	30-Compartment with Integrated Extender	2.88"	4.75"	14	4 ea
RW30-1 $\Delta$	30-Compartment with 2 Extenders	2.88"	6.34"	14	3 ea
RW30-2 $\Delta$	30-Compartment with 3 Extenders	2.88"	7.94"	14	2 ea
RW30-3 $\Delta$	30-Compartment with 4 Extenders	2.88"	9.5"	14	2 ea
REW30S	30-Compartment Extender	2.88"	1.5"	14	6 ea
<b>30-Compartment Color-Coded NeWave Glass Rack—Compartment Size 3.13" Dia</b>					
REW30SC	30-Compartment Divided Extender	3.56"	1.5"	04, 05, 09, 24, 89	6 ea
RW30-C $\Delta$	30-Compartment with Integrated Extender	2.88"	4.75"	410, 411, 412, 413, 414	4 ea
RW30-1C $\Delta$	30-Compartment with 2 Extenders	2.88"	6.34"	410, 411, 412, 413, 414	3 ea
RW30-2C $\Delta$	30-Compartment with 3 Extenders	2.88"	7.94"	410, 411, 412, 413, 414	2 ea
RW30-3C $\Delta$	30-Compartment with 4 Extenders	2.88"	9.5"	410, 411, 412, 413, 414	2 ea
RW30-4C $\Delta$	30-Compartment with 5 Extenders	2.88"	11.1"	410, 411, 412, 413, 414	1 ea

NSF Listed products are designated with a  $\Delta$  and may be prefixed with an N

\*Dimensions shown are for the recommended maximum glass size for the compartment



# OPTICLEAN®

## 9-Compartment

- Use with large brandy snifters, grande margaritas, carafes and other items with a wide diameter



RG9-1

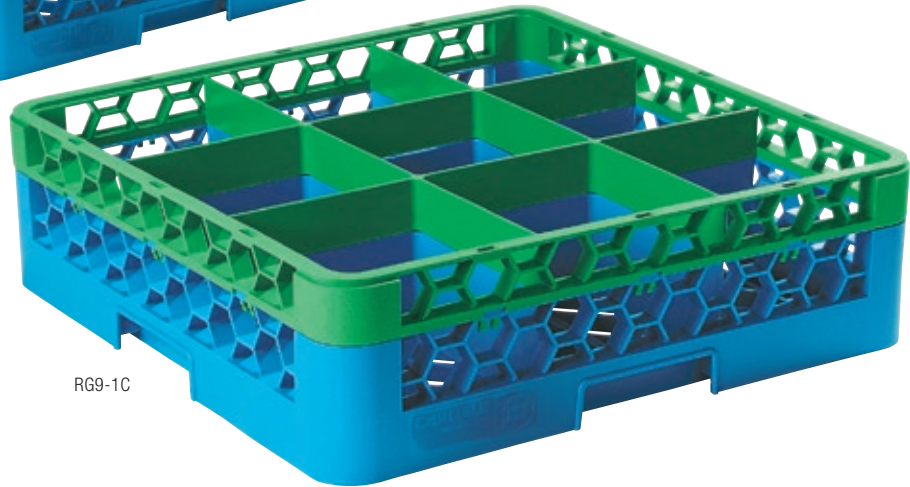

RG9-1C

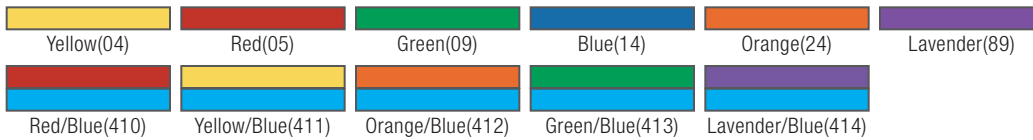

Prod No	Description	Glass Dia**	Glass Height	Color	Pack
<b>9-Compartment Glass Rack—Compartment Size 5.83" Square</b>					
RG9 Δ	9-Compartment	5.56"	3.19"	14	6 ea
RG9-1 Δ	9-Compartment with 1 Extender	5.56"	4.75"	14	4 ea
RG9-2 Δ	9-Compartment with 2 Extenders	5.56"	6.34"	14	3 ea
RG9-3 Δ	9-Compartment with 3 Extenders	5.56"	7.94"	14	2 ea
RG9-4 Δ	9-Compartment with 4 Extenders	5.56"	9.5"	14	2 ea
RG9-5 Δ	9-Compartment with 5 Extenders	5.56"	11.1"	14	2 ea
RE9	9-Compartment Divided Extender	5.56"	9.5"	14	6 ea
RE*	Open Extender	—	1.5"	14	6 ea
<b>9-Compartment Color-Coded Glass Rack—Compartment Size 5.83" Square</b>					
RG9-1C Δ	9-Compartment with 1 Extender	5.56"	4.75"	410, 411, 412, 413, 414	4 ea
RG9-2C Δ	9-Compartment with 2 Extenders	5.56"	6.34"	410, 411, 412, 413, 414	3 ea
RG9-3C Δ	9-Compartment with 3 Extenders	5.56"	7.94"	410, 411, 412, 413, 414	2 ea
RG9-4C Δ	9-Compartment with 4 Extenders	5.56"	9.5"	410, 411, 412, 413, 414	2 ea
RG9-5C Δ	9-Compartment with 5 Extenders	5.56"	11.1"	410, 411, 412, 413, 414	2 ea
RE9C	9-Compartment Divided Extender	5.56"	1.5"	04, 05, 09, 24, 89	6 ea
RE*	Open Extender	—	1.5"	14	6 ea

NSF Listed products are designated with a Δ and may be prefixed with an N

\*Note: The RE Open Extender can be used with any OptiClean Glass or Dish Rack

\*\*Dimensions shown are for the recommended maximum glass size for the compartment

**16-Compartment**

- Perfect for large cocktail glasses and delicate wine stems with oversize bowls



RG16-1



RG16-2C

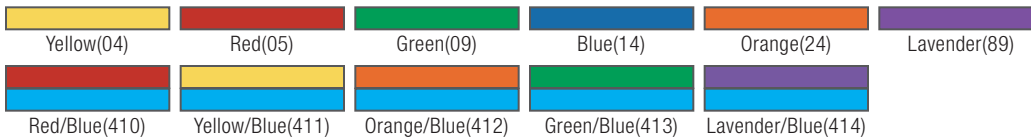

**Prod No   Description   Glass Dia\*\*   Glass Height   Color   Pack**

**16-Compartment OptiClean Glass Rack—Compartment Size 4.45" Square**

RG16 $\Delta$	16-Compartment	4.19"	3.19"	14	6 ea
RG16-1 $\Delta$	16-Compartment with 1 Extender	4.19"	4.75"	14	4 ea
RG16-2 $\Delta$	16-Compartment with 2 Extenders	4.19"	6.34"	14	3 ea
RG16-3 $\Delta$	16-Compartment with 3 Extenders	4.19"	7.94"	14	2 ea
RG16-4 $\Delta$	16-Compartment with 4 Extenders	4.19"	9.5"	14	2 ea
RG16-5 $\Delta$	16-Compartment with 5 Extenders	4.19"	11.1"	14	2 ea
RE16	16-Compt Divided Extender	4.19"	1.5"	14	6 ea
RE*	Open Extender	—	1.5"	14	6 ea

**16-Compartment OptiClean Color-Coded Glass Rack—Compartment Size 4.45" Square**

RG16-1C $\Delta$	16-Compartment with 1 Extender	4.19"	4.75"	410, 411, 412, 413, 414	4 ea
RG16-2C $\Delta$	16-Compartment with 2 Extenders	4.19"	6.34"	410, 411, 412, 413, 414	3 ea
RG16-3C $\Delta$	16-Compartment with 3 Extenders	4.19"	7.94"	410, 411, 412, 413, 414	2 ea
RG16-4C $\Delta$	16-Compartment with 4 Extenders	4.19"	9.5"	410, 411, 412, 413, 414	2 ea
RG16-5C $\Delta$	16-Compartment with 5 Extenders	4.19"	11.1"	410, 411, 412, 413, 414	2 ea
RE16C	16-Compartment Divided Extender	4.19"	1.5"	04, 05, 09, 24, 89	6 ea
RE*	Open Extender	—	1.5"	14	6 ea

NSF Listed products are designated with a  $\Delta$  and may be prefixed with an N  
 \*Note: The RE Open Extender can be used with any OptiClean Glass or Dish Rack

\*\*Dimensions shown are for the recommended maximum glass size for the compartment



# OPTICLEAN®

## 25-Compartment

- Use for large diameter beverage glasses, red wine stems, goblets and most rocks glasses



RG25-1

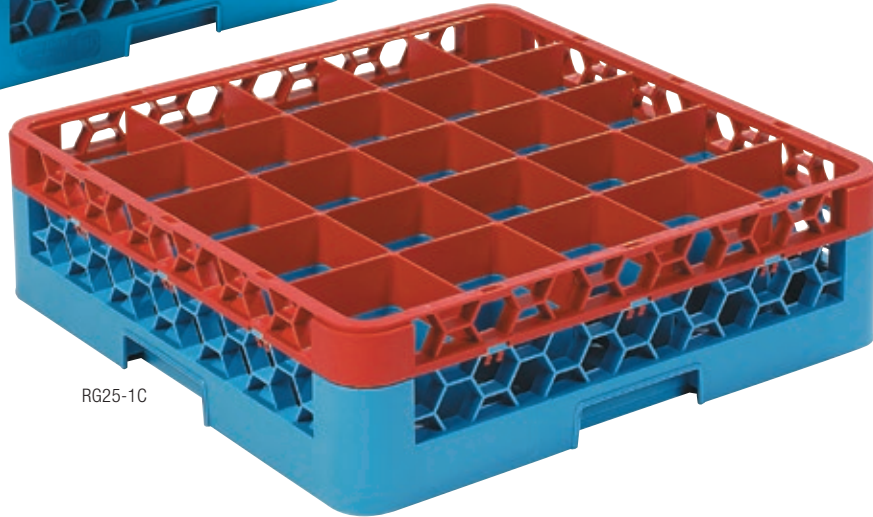

RG25-1C

Find The Perfect Glass Rack  
[www.carlislefsp.com/FINDRACK](http://www.carlislefsp.com/FINDRACK)

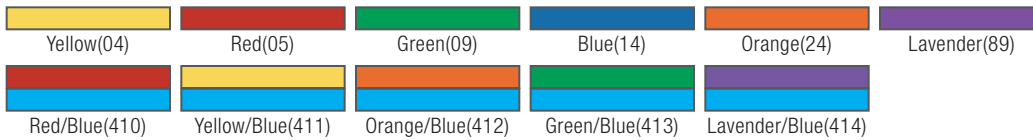

Prod No	Description	Glass Dia**	Glass Height	Color	Pack
<b>25-Compartment OptiClean Glass Rack—Compartment Size 3.54" Square</b>					
RG25 Δ	25-Compartment	3.25"	3.19"	14	6 ea
RG25-1 Δ	25-Compartment with 1 Extender	3.25"	4.75"	14	4 ea
RG25-2 Δ	25-Compartment with 2 Extenders	3.25"	6.34"	14	3 ea
RG25-3 Δ	25-Compartment with 3 Extenders	3.25"	7.94"	14	2 ea
RG25-4 Δ	25-Compartment with 4 Extenders	3.25"	9.5"	14	2 ea
RG25-5 Δ	25-Compartment with 5 Extenders	3.25"	11.1"	14	2 ea
RE25	25-Compartment Divided Extender	3.25"	1.5"	14	6 ea
RE*	Open Extender	—	1.5"	14	6 ea
<b>25-Compartment OptiClean Color-Coded Glass Rack—Compartment Size 3.54" Square</b>					
RG25-1C Δ	25-Compartment with 1 Extender	3.25"	4.75"	410, 411, 412, 413, 414	4 ea
RG25-2C Δ	25-Compartment with 2 Extenders	3.25"	6.34"	410, 411, 412, 413, 414	3 ea
RG25-3C Δ	25-Compartment with 3 Extenders	3.25"	7.94"	410, 411, 412, 413, 414	2 ea
RG25-4C Δ	25-Compartment with 4 Extenders	3.25"	9.5"	410, 411, 412, 413, 414	2 ea
RG25-5C Δ	25-Compartment with 5 Extenders	3.25"	11.1"	410, 411, 412, 413, 414	2 ea
RE25C	25-Compartment Divided Extender	3.25"	1.5"	04, 05, 09, 24, 89	6 ea
RE*	Open Extender	—	1.5"	14	6 ea

NSF Listed products are designated with a Δ and may be prefixed with an N

\*Note: The RE Open Extender can be used with any OptiClean Glass or Dish Rack

\*\*Dimensions shown are for the recommended maximum glass size for the compartment

### 36-Compartment

- Use with tumblers, white wine glasses and other narrow bowl stems

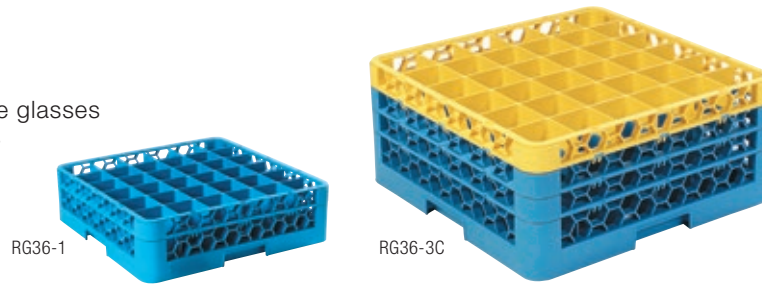

**Prod No Description Glass Dia\*\* Glass Height Color Pack**

#### 36-Compartment OptiClean Glass Rack—Compartment Size 2.94" Square

RG36 $\Delta$	36-Compartment	2.69"	3.19"	14	6 ea
RG36-1 $\Delta$	36-Compartment with 1 Extender	2.69"	4.75"	14	4 ea
RG36-2 $\Delta$	36-Compartment with 2 Extenders	2.69"	6.34"	14	3 ea
RG36-3 $\Delta$	36-Compartment with 3 Extenders	2.69"	7.94"	14	2 ea
RG36-4 $\Delta$	36-Compartment with 4 Extenders	2.69"	9.5"	14	2 ea
RG36-5 $\Delta$	36-Compartment with 5 Extenders	2.69"	11.1"	14	2 ea
RE36	36-Compartment Divided Extender	2.69"	1.5"	14	6 ea
RE*	Open Extender/Hgt: 1.5"	—	1.5"	14	6 ea

#### 36-Compartment OptiClean Color-Coded Glass Rack—Compartment Size 2.94" Square

RG36-1C $\Delta$	36-Compartment with 1 Extender	2.69"	4.75"	410, 411, 412, 413, 414	4 ea
RG36-2C $\Delta$	36-Compartment with 2 Extenders	2.69"	6.34"	410, 411, 412, 413, 414	3 ea
RG36-3C $\Delta$	36-Compartment with 3 Extenders	2.69"	7.94"	410, 411, 412, 413, 414	2 ea
RG36-4C $\Delta$	36-Compartment with 4 Extenders	2.69"	9.5"	410, 411, 412, 413, 414	2 ea
RG36-5C $\Delta$	36-Compartment with 5 Extenders	2.69"	11.1"	410, 412, 413, 414	2 ea
RE36C	36-Compartment Divided Extender	2.69"	1.5"	04, 05, 09, 24, 89	6 ea

### 49-Compartment

- Ideal for juice glasses, narrow champagne flutes, cordials and shot glasses

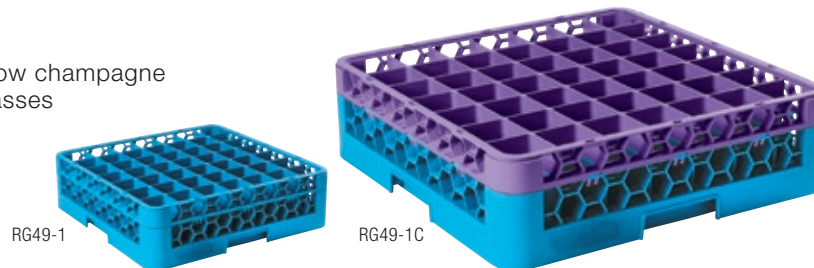

**Prod No Description Glass Dia\*\* Glass Height Color Pack**

#### 49-Compartment Glass Rack—Compartment Size 2.91" Square

RG49 $\Delta$	49-Compartment	2.13"	3.19"	14	6 ea
RG49-1 $\Delta$	49-Compartment with 1 Extender	2.13"	4.75"	14	4 ea
RG49-2 $\Delta$	49-Compartment with 2 Extenders	2.13"	6.34"	14	3 ea
RG49-3 $\Delta$	49-Compartment with 3 Extenders	2.13"	7.94"	14	2 ea
RG49-4 $\Delta$	49-Compartment with 4 Extenders	2.13"	9.5"	14	2 ea
RE49	49-Compartment Divided Extenders	2.13"	1.5"	14	6 ea
RE*	Open Extender	—	1.5"	14	6 ea

#### 49-Compartment Color-Coded Glass Rack—Compartment Size 2.91" Square

RG49-1C $\Delta$	49-Compartment with 1 Extender	2.13"	4.75"	410, 411, 412, 413, 414	4 ea
RG49-2C $\Delta$	49-Compartment with 2 Extenders	2.13"	6.34"	410, 411, 412, 413, 414	3 ea
RG49-3C $\Delta$	49-Compartment with 3 Extenders	2.13"	7.94"	410, 411, 412, 413, 414	2 ea
RG49-4C $\Delta$	49-Compartment with 4 Extenders	2.13"	9.5"	410, 411, 412, 413, 414	2 ea
RG49-5C $\Delta$	49-Compartment with 5 Extenders	2.13"	11.1"	410, 411, 412, 413, 414	2 ea
RE49C	49-Compartment Divided Extender	2.13"	1.5"	04, 05, 09, 24, 89	6 ea

NSF Listed products are designated with a  $\Delta$  and may be prefixed with an N

\*Note: The RE Open Extender can be used with any OptiClean Glass or Dish Rack

\*\*Dimensions shown are for the recommended maximum glass size for the compartment



# OPTICLEAN®

## Dish Racks

OptiClean Dish Racks offer the safest and most sanitary cleaning choices for everything from the most fragile tableware to heavy-duty kitchen items such as utensils and cutlery. These racks are NSF Listed and offer all the same great features as the rest of Carlisle's wash racks such as sturdy double wall construction and Comfort Curve™ Handles molded into all four sides.



### Peg Racks

- Holds plates, trays and platters at the best angle to take full advantage of today's multiple spray, high-pressure dishwashers
- Plate locks hold dishes firmly in place to protect delicate rims, reduce chipping and breakage
- Use with additional Open Extenders (RE) to create the perfect rack for irregular or oversize drinkware
- NSF Listed

### Tall Peg Plate & Tray Rack

- Extra tall 2.94" pegs are ideal for charger plates, pasta bowls, large platters and trays

### Open End Peg Rack

- Tall 2.94" pegs with open ended design hold all types of trays, standard size baking sheets and other long items

### Open/Bowl Rack

- Sturdy open bottom rack is ideal for all large bowls, containers, brushes, cookware and cutlery

### Combination/Flatware Rack

- Bottom grid allows for free flow of water and air
- Keeps flatware in place for thorough washing and drying
- Perfect for ramekins and other small items
- NSF Listed



RTP

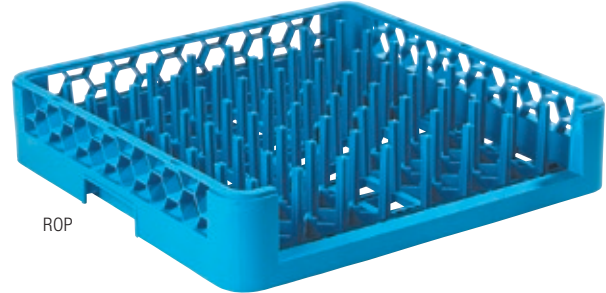

RTP



ROP



RB

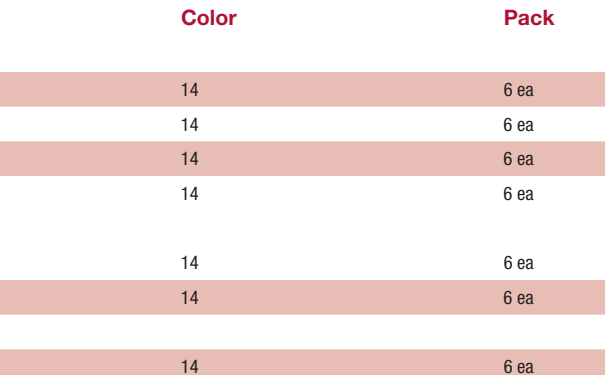

RF



Blue(14)

Prod No	Description	Color	Pack
<b>Peg Racks &amp; Extender</b>			
RP	All-Purpose Plate & Tray Rack	14	6 ea
RTP $\Delta$	Tall Peg Plate & Tray Rack	14	6 ea
ROP $\Delta$	Open End Peg Rack	14	6 ea
RE*	Open Extender	14	6 ea
<b>Open/Bowl Rack &amp; Extender</b>			
RB $\Delta$	Open/Bowl Rack	14	6 ea
RE*	Open Extender	14	6 ea
<b>Combination/Flatware Rack</b>			
RF $\Delta$	Combination/Flatware Rack	14	6 ea
RE*	Open Extender	14	6 ea

NSF Listed products are designated with a  $\Delta$  and may be prefixed with an N

\*Note: The RE Open Extender can be used with any OptiClean Glass or Dish Rack



### Cup Racks

- Tilted design promotes thorough washing of rims and interiors
- Encourages concaved bases to drain more efficiently, eliminating pooling water
- 16-Compartment holds larger diameter cups and mugs in tilted position; compartment size: 4.34" x 4.34"
- 20-Compartment works with most standard size cups; compartment size: 4.34" x 3.41"
- NSF Listed



### Bakery Tray & Sheet Pan Rack

- Rack securely holds sheet or bun pans low enough to fit standard height dish machine openings
- Contents are angled to take full advantage of multiple spray arms
- NSF Listed



### Food Pan/Insulated Meal Delivery Tray Rack

- Accommodates all sizes of 2.5" deep food pans and standard steam table inserts
- Racks are angled for thorough cleaning
- Perfect for health care or correctional facilities using insulated meal delivery compartment trays
- NSF Listed



### Plate Cover Rack

- Use with plate covers, dishwasher safe insulated dome covers or dishwasher safe pellet bases
- Specially designed insert keeps contents separated during washing
- NSF Listed



RC20-1



RSP



RFP



RPC

Blue(14)

**Prod No**    **Description**

**Color**

**Pack**

#### Cup Racks

RC16 $\Delta$	16-Compartment Cup Rack	14	6 ea
RC16-1 $\Delta$	16-Compartment Cup Rack with 1 Open Extender	14	4 ea
RC20 $\Delta$	20-Compartment Cup Rack	14	6 ea
RC20-1 $\Delta$	20-Compartment Cup Rack with 1 Open Extender	14	4 ea

#### Bakery Tray & Sheet Pan Rack

RSP $\Delta$	Bakery Tray & Sheet Pan Rack	14	3 ea
--------------	------------------------------	----	------

#### Food Pan/Insulated Meal Delivery Tray Rack

RFP $\Delta$	Food Pan/Insulated Meal Delivery Tray Rack	14	3 ea
--------------	--	----	------

#### Plate Cover Rack

RPC $\Delta$	Plate Cover Rack	14	3 ea
--------------	------------------	----	------

NSF Listed products are designated with a  $\Delta$  and may be prefixed with an N  
 \*Note: The RE Open Extender can be used with any OptiClean Glass or Dish Rack



# OPTICLEAN® ACCESSORIES

## Hold Down Grid

- Use with small, light-weight or delicate items to prevent them from being displaced by high pressure sprayers
- Snaps down securely and fits all OptiClean Glass & Dish Racks
- NSF Listed



C93



## Half Size Stack-All™ Racks

- Compact 10" x 19.75" size will work in any 19.75" dishwasher
- Sturdy single wall construction
- Open design for superior water and air circulation
- Made of high impact polypropylene
- NSF Listed

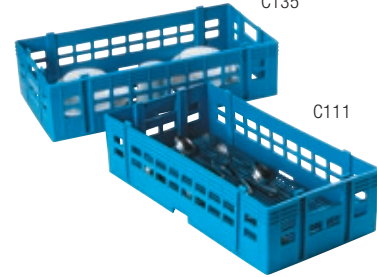

C135

C111



## Perma-Sil™ Cylinders & Carriers

### Flatware Cylinders

- Meshed bottom and open sides are best for the dispersion of water and air; ideal for washing or storing flatware

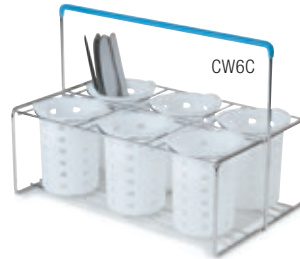

CW6C



C35P

### Carriers

- Heavy gauge wire construction is chrome plated
- Vinyl-coated insulated handle

## Perma-San™ Flatware Washing Baskets

- Open design for easy cleaning of vertically stored flatware
- Use with RF Flatware Rack or RB Open/Bowl Rack as part of a complete flatware sanitizing system
- Tough polypropylene material resists grease and detergents
- C32P1 and C32P2 are NSF Listed

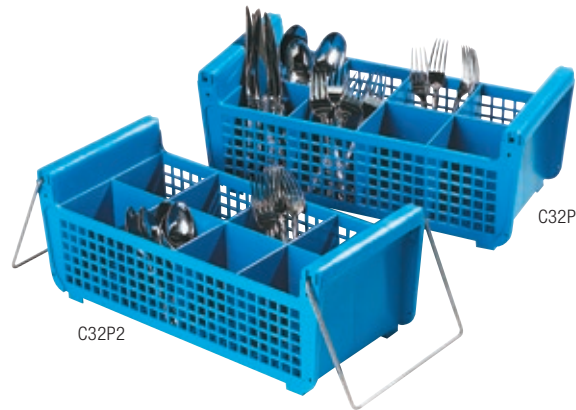

C32P1

C32P2

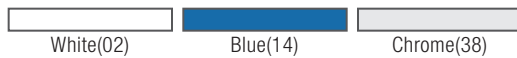

Prod No	Description	Glass Height	Color	Pack
<b>Hold Down Grid</b>				
C93 <span style="color: red;">▲</span>	Vinyl Coated Wire Grid	—	14	6 ea
<b>Half Size Stack-All Racks</b>				
C135 <span style="color: red;">▲</span>	Open Bowl/Cup/Glass Rack	4.5"	14	6 ea
C111 <span style="color: red;">▲</span>	Flatware Rack	4.5"	14	6 ea
<b>Perma-Sil Cylinders &amp; Carriers</b>				
C35P	Poly Cylinder	—	02	12 ea
CW6C	6-Compartment Portable Carrier	—	38	6 ea
C32P1 <span style="color: red;">▲</span>	Flatware Basket without Handles	—	14	6 ea
C32P2 <span style="color: red;">▲</span>	Flatware Basket with Handles	—	14	6 ea

NSF Listed products are designated with a ▲ and may be prefixed with an N

## E-Z Glide™ Rack Dollies

### Aluminum Dollies

- Hold and transport any 19.75" square stack of glass racks
- Large 4" ball bearing swivel casters with non-marking rubber wheels
- 300 lb weight capacity

### Polypropylene Dollies

- C2236/C2236H injection molded dollies squared corners are designed to hold any standard 19.75" racks including older style square racks
- 350 lb weight capacity
- Dollies trap water from wet racks; convenient drain feature underneath the dolly makes emptying water easy



### Dust Cover

- Heavy-duty vinyl covers keep tableware clean during storage
- Easily converts warewashing racks into storage racks
- Combine with E-Z Glide Dollies and Rack Covers (shown left) for a complete storage system

### Rack Cover

- Hard cover protects rack contents during storage



Prod No	Description	Color	Pack
<b>E-Z Glide Rack Dollies</b>			
C2220A	Open Aluminum Dolly, No Handle	14	1 ea
C2222A	Open Aluminum Dolly with Handle	14	1 ea
C2236	Warewashing Rack Dolly, No Handle	03, 14	1 ea
C2236H	Warewashing Rack Dolly with Handle	03, 14	1 ea
C2237	Handle for C2236 & C2236H	03	1 ea
C2222C	Replacement Caster for C2220A & C2222A	00	1 ea
C2222HD	Handle for C2220A & C2222A	38	1 ea
<b>Rack Cover</b>			
RHC	Rack Cover	02	1 ea
<b>Dust Covers</b>			
RDC ♦	36" Long Rack Dust Cover	07	3 ea
RDC1 ♦	48" Long Rack Dust Cover	07	3 ea

NSF Listed products are designated with a **Δ** and may be prefixed with an N

♦ California Residents: Di(2-ethylhexylphthalate) (DEHP) **WARNING:** See appendix B on page 1

# PLAQUE-A-RACK

Carlisle's Plaque-A-Rack System is the proven standard in custom rack labeling. The highly visible plaques fit up to three across on both bases and extenders for complete versatility. Plaques can be easily added, removed or changed as needed. Sturdy reusable plaques are made from a high-impact plastic and won't come off during the normal wear and tear of daily usage – offering a permanent identification system for the life of your racks.



Plaque example shown above: XRG25-2 with 203, 303, 103

- Plaque-A-Rack provides four ways to customize your Glass Rack System:
  - glassware silhouette
  - glassware style by name
  - location of glassware usage or storage
  - custom color coding options
- Plaques are hot stamped for durability
- Plaques are Carlisle Blue(14), unless otherwise specified
- All plaques are 3" long by 1" high with a printable area of 2-1/4" long by 11/16" high
- Racks can be ordered with up to three possible plaque imprints
- There is a \$4.16 U.S. list price charge per rack for each Plaque-A-Rack order (includes 2 plaques on 2 sides); special orders for plaques on all four sides have a \$8.32 U.S. list price (includes 2 plaques on 4 sides)
- Plaques may also be ordered separately at \$1.04 U.S. list price each
- Plaques are placed horizontally on two opposite

- sides of the rack along the top most edge
- Plaques snap on for a tight fit; won't fall off during normal use
- Plaques can be removed if necessary and are re-usable
- Allow ten working days for shipment of your standard order
- Plaqued racks sold in full case quantities only
- Please allow 4-6 weeks from approval of sample for custom plaques
- Custom imprinted plaques are \$1.04 U.S. list price each with an additional \$50 U.S. net price setup fee per plate
- An additional \$142 U.S. net price dye charge will apply to any plaque order that does not include racks
- For custom color coding, please specify which color is to be used for each rack
- Custom plaques have a max of 9 characters in upper/lower case; 7 character max in all caps
- All plaque sales are final

## How To Order

Follow instructions below and refer to the charts on the facing page for catalog numbers.

**Step 1:** Choose the glass rack that best fits your glassware.

**Step 2:** Plaque-A-Rack glass racks are identified by an "X" preceding the standard glass rack catalog number (example: "X"RG25-1 25-Compartment Plaque-A-Rack glass rack with one extender).

**Step 3:** Choose the different imprints you want from the types of plaque imprints available.

- Silhouette
- Name of glassware
- Location

**Step 4:** Place the three digit plaque catalog imprint product number next to the standard glass rack catalog number.

### EXAMPLE:

Rack Choice: RG25-1  
 Silhouette: Red Wine  
 Glassware Name: Red Wine  
 Location: Service Bar  
 Catalog No: XRG25-1    204    304    104

### Standard Color







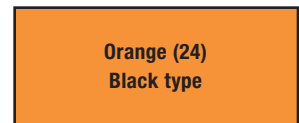





















### Custom Colors

- Minimum order 36 pieces



**LOCATION**
**GLASS RACK**

CAT. NUMBER	IMPRINT	CATALOG NUMBER		
100	(BLANK)	XRG16	XRG25-2	XRG36-4
101	KITCHEN	XRG16-1	XRG25-3	XRG9
102	DINING	XRG16-2	XRG25-4	XRG9-1
103	BANQUET	XRG16-3	XRW30	XRG9-2
105	POOLSIDE	XRG16-4	XRW30-1	XRG9-3
106	STORAGE	XRW20	XRW30-2	XRG49
107	RM SERV	XRW20-1	XRW30-3	XRG49-1
108	BALLROOM	XRW20-2	XRG36	XRG49-2
109	BAR	XRW20-3	XRG36-1	XRG49-3
110	HOUSEKEEPING	XRG25	XRG36-2	
		XRG25-1	XRG36-3	

SILHOUETTE		NAME OF GLASS		SILHOUETTE		NAME OF GLASS	
CAT.#	IMPRINT	CAT.#	IMPRINT	CAT.#	IMPRINT	CAT.#	IMPRINT
PLQ	(BLANK)	PLQ	(BLANK)	214		314	MUG
201		301	CHAMPAGNE	215		315	FOOTED CUP
202		302	CHAMPAGNE	217		317	HI BALL
203		303	WHITE WINE	218		318	ICED TEA
204		304	RED WINE	219		319	FLUTED
205		305	ROCKS	221		321	GOBLET
206		306	WATER	222		322	WINE
207		307	COOLER	224		323	MARGARITA
208		308	PILSNER	226		324	BEER
209		310	PARFAIT	227		326	HURRICANE
211		311	BRANDY	228		327	MARTINI
212		312	TULIP	229		328	CORDIAL
213		313	SOUR	230		329	DESSERT
				235		330	CUP
						335	OLD FASHION
						633	COFFEE CUP

# BUS BOXES

## Tote Boxes

- Unique reinforced rims reduce bending, bowing, and breaking
- Excellent for storing and separating food products
- Comfort Curve™ handles for a sure, comfortable grip
- Contour lid design allows easy box-on-box stacking
- Available in 8 different colors for HACCP zone use
- NSF Std 21 – meets the criteria for thermoplastic refuse containers
- NSF Std 2 – meets the criteria for food contact and cleanability

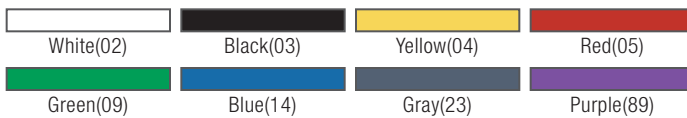

Prod No	Description	Color	Pack
<b>Tote Boxes</b>			
N44010 Δ	Tote Box 15" x 20" x 5" Deep	02, 03, 04, 05, 09, 14, 23, 89	12 ea
N44011 Δ	Tote Box 15" x 20" x 7" Deep	02, 03, 04, 05, 09, 14, 23, 89	12 ea
N44012 Δ	Universal Lid	02, 03, 04, 05, 09, 14, 23, 89	12 ea

NSF Listed products are designated with a Δ and may be prefixed with an N

## Save-All™ Compartmented Bus Boxes

- Silverware tray and heavy-duty bus boxes feature contoured handles for easy handling
- Scuff, grease and stain-resistant
- Silverware Tray measures 21.25" x 11.5" x 3.75" H
- 0386 Save-All Bus Box has separate compartments, one for flatware, one for plates and debris; measures 22" x 17" x 5" H
- Dishwasher safe



## Bus Boxes

- Unique reinforced rims reduce bending, bowing and breaking – protecting your valuable tableware investment
- Comfort Curve™ handles for a sure, comfortable grip
- Contour lid design allows easy box-on-box stacking
- 44010, 44011, 44012 in White are NSF Listed



44011SKD



44011 with 44012 Lid



Use Bus Boxes to create a Wash-Rinse-Sanitize station



Prod No	Description	Color	Pack
<b>Save-All Compartmented Bus Boxes</b>			
1071	Save-All Silverware Tray	23	6 ea
0386	Save-All Bus Box	23	12 ea
<b>Bus Boxes</b>			
44010	Bus Box 15" x 20" x 5" Deep	01, 02, 03, 23	12 ea
44011	Bus Box 15" x 20" x 7" Deep	01, 02, 03, 23	12 ea
44012	Universal Lid	01, 02, 03, 23	12 ea
44010SKD*	Bus Box Skid 15" x 20" x 5" Deep	03, 23	300 ea
44011SKD*	Bus Box Skid 15" x 20" x 7" Deep	03, 23	240 ea

\*Note: 44010SKD, 44011SKD cannot ship UPS/FedEx Ground



**CARLISLE**  
FOODSERVICE PRODUCTS



PROVEN  
EFFICIENT  
RELIABLE  
**CLEANING  
TOOLS**

---

*Trust Carlisle's equipment cleaning brushes and kitchen tools to help keep your food service operation healthy, safe and profitable. These products are another way Carlisle helps you make work easy.*



# SPARTA



## The Right Brush For Every Job

We offer more than 2,000 brushes and cleaning tools, each ergonomically designed with the end user in mind to provide optimum cleaning results for *you*.



### Since 1908

we've been manufacturing high-quality brushes and cleaning tools. We have developed unmatched expertise, consistently delivering innovative cleaning solutions.



### The Highest Quality

and best suited materials for efficient use and durability. These outstanding Sparta Brush features save you time and money.



### Custom Designed

for each specific cleaning application.



### Proven

Sparta Brush quality excels in foodservice and food processing including fine restaurants, hotels, schools, hospitals, lunch counters, cafeterias, supermarket bakeries, meat departments and delicatessens.

### Our Commitment

to the customer never ends and our mission is to give 100% customer satisfaction.

**SPARTA**  
BRUSH



# Maintain a healthy foodservice environment with the **Sparta® 21 Key Brush** solution!

This program is specifically tailored for food service operators to help you prevent the spread of food-borne illness and comply with FDA Food Codes

## PASTRY & BASTING



#1 Hot Use  
40374



#2 Cold Use  
40401



#3 Silicone Basting Brush  
40405

## FLOOR CLEANING



#4 24" Double Foam Rubber Squeegee  
40082



#5 Hi-Lo™ Floor Scrub  
40423



#6 Duo-Sweep™ Angle Broom  
36885



#7 24" Omni® Floor Sweep  
41881

## FOOD PREPARATION



#8 Vegetable Brush  
40164



#9 6" Cutting Board Brush  
40521

## GENERAL CLEANUP



#10 8" Polyester Scrub Brush  
40541



#11 20" Polyester Scrub Brush  
40501



#12 Scratch Brush with Scraper  
40671

## KITCHEN EQUIPMENT



#13 Broiler Master Brush  
40290



#14 L-Tipped High Heat Fryer Brush  
40111

## BEVERAGE SERVICE



#15 12" Carafe/Bottle Brush  
40000



#16 Coffee Decanter Brush  
40025

## FLOOR DRAIN CLEANING



#17 Floor Drain Brush  
40146



#18 36" Plastic Drain Brush Handle  
40236



#19 Drain Opening Tool  
40144

## WASHROOM & PERSONAL HYGIENE



#20 Hand and Nail Brush  
40020



#21 Polyester Bowl Brush  
40140

## 21 Key Brush Kit - 990021KIT00

# 21 KEY BRUSHES

**#3** Silicone Basting Brush **40405**



**#13** Broiler Master Brush **40290**



**#14** L-Tipped High Heat Fryer Brush **40111**



**#12** Scratch Brush w/ Scraper **40671**



**#1** Hot Use **40374**



**#2** Cold Use **40401**



**#5** Hi-Lo Floor Scrub **40423**



**#17** Floor Drain Brush **40146**



**#18** 36" Plastic Drain Brush Handle **40236**



**#19** Drain Opening Tool **40144**



**#10** 8" Polyester Scrub Brush **40541**



**21 Key Brush Kit - 990021KIT00**

**#16** Coffee Decanter  
Brush **40025**



**#15** 12" Carafe/Bottle  
Brush **40000**



**#20** Hand & Nail  
Brush **40020**



**#21** Polyester Bowl  
Brush **40140**

**#8** Vegetable  
Brush **40164**



**#11** 20" Polyester  
Scrub Brush **40501**



**#9** 6" Cutting  
Board Brush **40521**



**#4** 24" Double Foam  
Rubber Squeegee **40082**



**#6** Duo-Sweep™ Angle  
Broom **36885**



**#7** 24" Omni® Floor  
Sweep **41881**



# SMALLWARES BRUSHES

## Atlas™ Multi-Purpose Brushes

- Versatile design for a wide variety of applications
- Multiple trim angles on bristles give you better surface contact for better cleaning
- Available with ergonomic pistol grip handles in 8" and 20" lengths
- Rugged plastic handles and crimped staple set polyester bristles will not absorb oils or moisture
- Base resins used to produce blocks and bristles are made of FDA compliant materials
- Full color-coded products offer easy identification for tool segregation



	Allergen Control
	Dairy or Dry Food
	Produce
	Prepared Food
	Meat
	Fish
	Poultry



**SPARTA**  
BRUSH  
Famous for Quality

## Cutting Board Brushes

- Ergonomically shaped handles and crimped staple set polyester bristles are rugged and will not absorb food oils or moisture
- Segregate brushes and boards by color to help prevent cross contamination
- Base resins used to product blocks and bristles are made of FDA compliant materials



White(02)	Black(03)	Yellow(04)	Red(05)	Green(09)
Blue(14)	Tan(25)	Purple(68)	Purple(89)	

**Prod No Description Recommended Cleaning Color Pack**

### Atlas Multi-Purpose Brushes

40000	12" Handle, 2.75" Round with Soft Polyester Bristles	Drinkware/Dishes	02, 25	12 ea
40000C	12" Handle, 2.75" Round with Soft Polyester Bristles, Color-Coded	Drinkware/Dishes	02, 04, 05, 09, 14	6 ea
40001	16" Handle, 3.25" Round with Soft Polyester Bristles	Drinkware/Dishes	02, 03, 68	12 ea
40001C	16" Handle, 3.25" Round with Soft Polyester Bristles, Color-Coded	Drinkware/Dishes	02, 04, 05, 09, 14	6 ea
40002	16" Handle, 3.5" x 5" Oval with Polyester Bristles	Pots/Pans/Tanks	02	6 ea
40002C	16" Handle, 3.5" x 5" Oval with Polyester Bristles, Color-Coded	Pots/Pans/Tanks	04, 05, 09, 14	6 ea
40003	30" Handle, 3.5" x 5" Oval with Polyester Bristles	Pots/Pans/Tanks	02	6 ea
40003C	30" Handle, 3.5" x 5" Oval with Polyester Bristles, Color-Coded	Pots/Pans/Tanks	04, 05, 09, 14	6 ea
40004	16" Handle, 3" Round with Polyester Bristles	Pots/Pans/Tanks	02	6 ea
40004C	16" Handle, 3" Round with Polyester Bristles, Color-Coded	Pots/Pans/Tanks	04, 05, 09, 14	6 ea
40005	16" Handle, 4" Round with Polyester Bristles	Pots/Pans/Tanks	02	6 ea
40005C	16" Handle, 4" Round with Polyester Bristles, Color-Coded	Pots/Pans/Tanks	04, 05, 09, 14	6 ea
40006	30" Handle, 3" Round with Polyester Bristles	Pots/Pans/Tanks	02	6 ea
40006C	30" Handle, 3" Round with Polyester Bristles, Color-Coded	Pots/Pans/Tanks	04, 05, 09, 14	6 ea
40007	30" Handle, 4" Round with Polyester Bristles	Pots/Pans/Tanks	02	6 ea
40007C	30" Handle, 4" Round with Polyester Bristles, Color-Coded	Pots/Pans/Tanks	04, 05, 09, 14	6 ea
40008	30" Handle, 5" Round with Polyester Bristles	Pots/Pans/Tanks	02	6 ea
40008C	30" Handle, 5" Round with Polyester Bristles, Color-Coded	Pots/Pans/Tanks	04, 05, 09, 14	6 ea
40010	16" Handle, 5" Round with Polyester Bristles	Pots/Pans/Tanks	02	6 ea
40010C	16" Handle, 5" Round with Polyester Bristles, Color-Coded	Pots/Pans/Tanks	04, 05, 09, 14	6 ea

### Cutting Board Brush

40521	6" Cutting Board Brush with Polyester Bristles, 1.38" trim	—	02, 04, 05, 09, 14, 25, 89*	12 ea
-------	--	---	-----------------------------	-------

\*Color available by special order only

## Sparta® Glass Washing Brushes

- All plastic construction helps prevent glasses from being chipped or broken and helps seal out moisture
- Positive-suction, molded plastic base provides a tight grip in sinks and on countertops
- Heavy-duty polyester bristles with densely filled dome top holds up to extreme use



## Sparta Bottle & Jar Brushes

- Wirewound brushes have a small diameter handle and soft bristles for easy and delicate cleaning of jars, bottles and glasses with smaller openings
- 40415 Bottle Brush is perfect for cleaning wine bottles, ketchup bottles, squeeze bottles, beer growlers, etc.

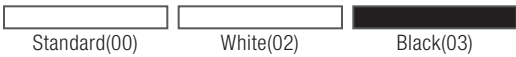

Prod No	Description	Recommended Cleaning	Color	Pack
<b>Sparta Glass Washing Brushes</b>				
40460	8" Twin Glass Washer, 2.88" trim	Drinkware	03	6 ea
40461	8" Triple Glass Washer, 2.88 trim	Drinkware	02, 03	6 ea
41506	9.5" Pilsner, Hurricane & Standard Style Triple Glass Washer	Drinkware	00	6 ea
40465	Standard Refill Brush	Drinkware	03	12 ea
40462	Shot Glass Cleaning Brush	Drinkware	03	6 ea
<b>Sparta Bottle &amp; Jar Brushes</b>				
40466	12" Handle Pint Bottle Brush with Polyester Bristles, 2.5" - 3.5" trim	Jars/Carafes/Bottles	00	12 ea
40467	16" Handle Quart Bottle Brush with Polyester Bristles, 3" - 4.25" trim	Jars/Carafes/Bottles	02	12 ea
40468	16" Handle Half Gallon Brush with Polyester Bristles, 4" - 4.5" trim	Jars/Carafes/Bottles	00	12 ea
40415	16.5" Handle Small Bottle Neck Brush with Soft Nylon Bristles	Small Neck Bottles	00	12 ea

# SPECIAL EQUIPMENT BRUSHES

## Hot Dog Roller Brush

- Special “V” shaped stiff polyester bristle design cleans hot dog rollers and connecting points at the side walls at one time
- Rids hot dog roller grills of unsanitary grease build-up that could result in mechanical problems



## High Temp Fryer Brushes

- Made of stiff, PTFE bristles that withstand temperatures up to 500°F
- Saves time since equipment can be cleaned while hot
- Plastic handles stay cool to the touch
- 40110 Fryer Brush is 28" long to reach tight, narrow spaces
- 40112 Looped Brush cleans fryer bottoms easily
- 40111 and 40116 L-Tipped Fryer Brush for cleaning hot coils
- 40113 Utility Brush for cleaning hot vats, utensils and other equipment



## High Temp Waffle & Panini Griddle

- Made of stiff, high heat bristles that withstand temperatures up to 500°F
- Saves time since equipment can be cleaned while hot
- Plastic handles stay cool to the touch
- 40114 has extra stiff bristles for cleaning waffle irons, griddles and grills while still hot
- 40115 is a pastry style brush designed for buttering and basting hot surfaces



Prod No	Description	Trim	Color	Pack
<b>Hot Dog Roller Brush</b>				
41169	24" L Hot Dog Roller Brush	2"	00	12 ea
<b>High Temp Fryer Brushes</b>				
40110	28" Straight Fryer Brush	1.38"	05	12 ea
40120	28" Straight Fryer Brush	1.38"	05	1 ea
40112	24" Looped Fryer Brush	2"	05	6 ea
40122	24" Looped Fryer Brush	2"	05	1 ea
40111	23" L-Tipped Fryer Brush	.88"	05	12 ea
40121	23" L-Tipped Fryer Brush	.88"	05	1 ea
40113	20" Utility Brush	2"	05	12 ea
40123	20" Utility Brush	2"	05	1 ea
<b>High Temp Waffle, Griddle &amp; Equipment Brushes</b>				
40114	3" Wide Brush with Teflon Bristles	.94" - 1"	00	12 ea
40115	1" Round Brush with Teflon Bristles	2"	00	12 ea

NOTE: Heat coil must be turned off prior to using high temperature brushes



## Sparta Coffee Service Brushes

- Brushes are designed to clean all glass and Pyrex® pots and dispensers
- 40025 Coffee Decanter Brush is shaped like the inside of the most popular coffee decanters for quick and easy use
- Use 40673 Urn Brush for quick and easy clean-up of glass gauges on coffee urns
- 40154 Creamer and Percolator Brush is designed for cleaning spouts and tubing on percolators, hot beverage servers and creamers
- 40153 Curved Coffee Maker Brush is a semi-circular wire wound brush that contours to the inside of coffee pots



## Spouts, Pumps & Valves - Stiff Polyester Bristles

### Tee, Fitting and Valve Brush (40180)

- Perfect for straight pipes, tees and valves

### Condiment Dispenser Spout Brush (40155)

- Flexible wire for efficient cleaning of bacteria prone spouts

### Condiment Dispenser Plunger Brush (40156)

- Rose-bud tip for efficient dispenser cleaning

### Beer Tap Line Brush (40157)

- Great for maintaining quality control of beer on tap



Prod No	Description	Recommended Cleaning	Color	Pack
<b>Sparta Coffee Service Brushes</b>				
40025	16" Coffee Decanter Brush with Soft Polyester Bristles, 4.6" - 6.4" trim	Coffee Decanter	00	6 ea
40673	25" Handle Urn Brush with Polyester Bristles, .63" trim	Coffee Urn & Tap	00	12 ea
40154	12" Creamer Brush with Polyester Bristles, 1" x 1.5" trim	Coffee Spout	00	24 ea
40153	10" Curved Coffee Maker Brush with Soft Polyester Bristles, 1.5" trim	Coffee Maker	00	12 ea
<b>Spouts, Pumps &amp; Valve Brushes</b>				
36552	8" Spout Brush	Spouts/Faucets	00	144 ea
40157	5.25" Beer Tap with Polyester Bristles, .25" trim	Beer Taps	00	24 ea
40180	15" Valve & Fitting with Polyester Bristles, 1" trim	Valves & Fittings	02	12 ea
40155	13" Spout Brush with Polyester Bristles, .44" trim	Condiment Pumps	00	12 ea
40156	10.5" Plunger Brush with Polyester Bristles, .94" trim	Condiment Pumps	00, 14	12 ea

# EQUIPMENT CLEANING BRUSHES

## Wok/Gong Utility Brushes

- Clean woks and electric griddles; designed specifically for high heat cleaning
- Wood block handle available in two lengths
- Stiff palmyra bristles are excellent for general cleaning



## Low Temperature Equipment Brushes

- 40040 and 40042 Tank and Kettle Brushes have bristles on all sides to provide complete cleaning and can be used with a handle to reach the bottom of kettles and tanks
- 40150 Kettle Drain Valve Brush is a perfect solution for cleaning bacteria prone areas of kettles
- 40152 Cool Temperature Fryer Brush has the same shape as our High Temp Fryer Brush(40111) but is used in cool cleaning



## Dishwasher Machine Brush

- Long handle reaches spray arms for more thorough cleaning



Standard(00)

Prod No	Description	Recommended Cleaning	Color	Pack
<b>Wok/Gong Utility Brushes</b>				
45463	8.5" Utility Scrub Brush with Stiff Palmyra Bristles	Wok/Gong/Electric Griddles	00	12 ea
45493	20" Utility Scrub Brush with Stiff Palmyra Bristles	Wok/Gong/Electric Griddles	00	12 ea
<b>Low Temperature Equipment Brushes</b>				
40040	Tank & Kettle Brush with Nylon Bristles, 5.25" x 7.5" trim	Kettle & Tank	00	12 ea
40042	Tank & Kettle Brush with Nylon Bristles, 5.5" x 9.5" trim	Kettle & Tank	00	12 ea
40150	28" Kettle Valve with Stiff Polyester Bristles, 1.38" trim	Kettle Valve	00	12 ea
40152	23" Cool L-Tipped Fryer with Polyester Bristles, .88" trim	Fryer	00	12 ea
<b>Dishwasher Machine Brush</b>				
40028	35" Dishwasher Spray Arm with Polyester Bristles, 1" trim	Dishwasher	00	12 ea

### Bake Pan Lip Brush

- Easy cleaning of rolled lips and edges on baking pans
- Stiff polyester bristles patterned in a flat V-shape for maximum pan contact
- Contoured handle provides a convenient grip and protects hands from metal edges on pans and other equipment



40024

### Vegetable Cutter Brushes

- 40529 has 2.5" long, extra stiff nylon bristles reach through the grid of stainless steel cutters
- 40532 has 4.25" long, extra stiff, nylon bristles



40532



40529

### Iron Handle Brush

- Pointed edge to allow cleaning in corners
- Iron style grip is ergonomically designed for comfort and light or medium duty scrubbing



36289



Prod No	Description	Recommended Cleaning	Color	Pack
<b>Bake Pan Lip Brush</b>				
40024	6" Bake Pan Lip Brush with Polyester Bristles, 1" trim	Baking Pans	02, 04, 05, 09, 14	12 ea
<b>Cutter Brush</b>				
40529	2.5" Vegetable Cutter Brush with Nylon Bristles, 2" trim	Lettuce & Onion Cutters	00	12 ea
40532	4.25" Universal Onion/Lettuce Brush	Lettuce & Onion Cutters	00*	8 ea
<b>Iron Handle Brush</b>				
36289	6" Iron Handle Brush with Polypropylene Bristles	Medium Scrubbing/Corner Areas	00	48 ea

# EQUIPMENT CLEANING

## Toothbrush Style Utility Brushes

- Narrow profile cleans tight kitchen spaces and around ceramic tile
- Available in a choice of .5" long stiff nylon bristles for normal cleaning; stainless steel or brass bristles for tougher cleaning jobs



## Butcher Block Brushes

- Aggressive tempered steel wire bristles scrape away contaminated layers of wooden butcher blocks and wooden cutting boards



## Meat Slicer Cleaning Tool

- Keeps hands and fingers away from slicer blade
- Easy clean-up of slicers without disassembling slicer
- Slicer tool has scraper on one end for scraping hardened foods
- Scrub pad wraps around meat slicer tool for a one-time thorough cleaning



Prod No	Description	Recommended Cleaning	Color	Pack
<b>Toothbrush Style Utility Brushes</b>				
40674	7" Plastic Handle with .5" Nylon Bristles	Tile/General Purpose	00	12 ea
40675	7" Plastic Handle with .5" Stainless Steel Bristles	Ovens/Grills/Small tough areas	00	12 ea
41270	7" Plastic Handle with .5" Brass Bristles	Ovens/Grills/Small tough areas	00	12 ea
<b>Butcher Block Brushes</b>				
40676	4" x 9" Brush with Flat Steel Bristles	Butcher Block	00	12 ea
45781	2.63" x 7.75" Brush with Steel Bristles	Butcher Block	00	12 ea
<b>Meat Slicer Cleaning Tool</b>				
40728	Meat Slicer Cleaning Tool	Meat Slicer Blade	25	12 ea
40729	Meat Slicer Scrub Pad	Meat Slicer Blade	08	12 pk

# DISHWARE CLEANING

## Scrubs & Sponges

- 36752 is a long-lasting 400 series stainless that won't rust or splinter
- 36396: aggressive pad for use in place of steel wool – not recommended for coated cookware, soft plastics, fine china or polished stainless steel as scratching can occur

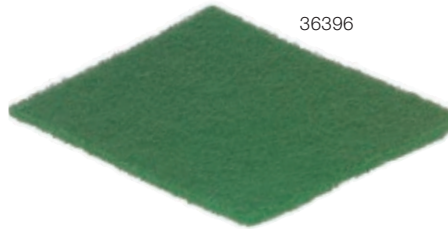

## Dish Brushes

- 40413 has a 180° brush head and full end bristles to prevent splash back when in use cleaning dishes, utensils and fry pans
- 3610140 is perfect for scraping off food before placing in dishwasher



Prod No	Description	Recommended Cleaning	Color	Pack
<b>Scrubs &amp; Sponges</b>				
36396	9" x 6" x .25" Medium Duty Scour Pad 10 ea/pack, 6 packs/case	Pots/Pans/Equipment	08	6 ea
36752	35 g Stainless Steel Scrub, 400 Series 12 ea/pack, 6 packs/case	Pots/Pans/Oven	00	6 ea
365501	8.25" x 4.25" x 2.25" Extra Large Sponge	Dishes	00	24 ea
<b>Dish Brushes</b>				
40413	12" Handle Dish Brush with Polyester Bristles, 2.75" trim	Dishes/Utensils	00	12 ea
367600TC	11" Handle Dish Brush with Polyester Bristles, 2.75" trim	Dishes/Utensils	02	6 ea

# EQUIPMENT CLEANING

## Oven & Grill Brushes

- Wire brushes and stainless steel metal scrapers make quick and easy removal of heavy carbon deposits, rust and burned-on food build up

### Broiler Master

The best grill brush available and master of all grill cleaning tools. Rust-proof bristles are embedded in a rugged specially treated hardwood block for long-lasting cleaning power.



### Double Broiler King 40294

- Sturdy construction with two heads featuring carbon steel flat bristles on one side and carbon steel wire bristles on the other; bolted together on a heavy hardwood handle for very heavy use

### Oven Brush 41520 & 40291

- Crimped brass wire bristles and a full length stainless steel scraper for cleaning high-temperature stack ovens

### Oven Brush 40293

- Crimped brass wire bristles and a full length aluminum scraper on a low-profile head for cleaning the narrow spaces inside pizza ovens

### Pizza/BBQ Oven Brush 45772

- Steel wire bristles and permanent 39" hardwood handle

### Oven & Grill Brush 363725

- Flat wire stainless steel bristles, oven scraper and 30" handle



40291



40293



363725



40290



45772



40294

Standard(00)

Prod No	Description	Color	Pack
<b>Oven &amp; Grill Brushes</b>			
40026	8.5" Broiler Master Brush, Carbon Steel Bristles with 30" Handle	00	6 ea
40290	8.5" Broiler Master Brush, Stainless Steel Bristles with 30" Handle	00	6 ea
40294	8" Double Broiler King, Carbon Steel Flat & Wire Bristles with 48" Handle	00	2 ea
41520	8.5" Oven Brush & Scraper, Brass Wire Bristles with 42" Handle	00	1 ea
40291	8.5" Oven Brush & Scraper, Brass Wire Bristles (Head Only)	00	12 ea
40293	10" Oven Brush & Scraper, Brass Wire Bristles (Head Only)	00	12 ea
45772	5.5" Pizza/BBQ Oven Brush, Carbon Steel Bristles and 33" Handle	00	12 ea
363725	8" Oven Brush with Scraper, Flat Wire Stainless Steel Bristles with 30" Handle	00	1 ea

NOTE: Equipment must be turned off prior to using Oven & Grill Brushes  
 \*40291 & 40293 do not include handles; use with handle 40275 shown on page 295

## Grill Bricks, Screens & Polishing Pads

- Apply with cooking oil to protect the grill, cure and remove excess cooked-on foods
- 40710 Grill Brick is a fast, efficient and sanitary way to clean hot or cold grills
- Plastic wrapping on Grill Brick dissolves to eliminate mess
- 40713 Grill Screen and 40711 Grill Polishing Pad attach to the 40712 Grill Pad Holder for a complete grill maintenance system



40710



40711



40712  
40713  
40711

## Scratch Brushes

- Compact profile for heavy scraping and cleaning in tight, narrow spaces; provides quick, aggressive removal of grease and deposits
- Available with wood handles for cleaning hot grills and ovens
- Available in nylon, stainless steel or carbon steel wire bristles for normal to tougher cleaning jobs



Standard(00)



45779

40671

40670

40672

40027

45571

Prod No	Description	Handle	Color	Pack
<b>Grill Bricks, Screens &amp; Polishing Pads</b>				
40710	3.5" x 4" x 8" Grill Brick	—	00	12 ea
40711	4" x 5" x .25" Grill Polishing Pads, 10 ea/pack, 6 pks/case	—	00	6 pks
40712	Grill Pad Holder	Plastic	00	10 ea
40713	4" x 5.5" Grill Screen, 20 ea/pack, 10 pks/case	—	00	10 pks
<b>Scratch Brushes</b>				
45779	11" Brush & Scraper with Carbon Steel Bristles	Wood	00	12 ea
40671	11.5" Scratch Brush & Scraper with Carbon Steel Bristles	Plastic	00	12 ea
40670	11.5" Scratch Brush with Carbon Steel Bristles	Plastic	00	12 ea
40672	11.5" Scratch Brush & Scraper with Stainless Steel Bristles	Plastic	00	12 ea
40027	11.5" Scratch Brush with Nylon Bristles	Plastic	00	12 ea
45571	20" Brush & Scraper with Carbon Steel Bristles	Wood	00	12 ea

NOTE: Equipment must be turned off prior to using Scratch Brushes

# HAND & NAIL

**Reduce the risk of foodborne illness breakouts with our hand & nail brushes.** Every wash station in a foodservice operation should have a Carlisle Hand & Nail Brush.

## Hand & Nail Brushes

- Designed to promote vital cleansing of hands for foodservice personnel
- 40020 has stiffer center bristles for a more thorough cleaning under fingernails and longer bristles along the sides clean finger's top and bottom
- 40021 kit includes 5" x 2" brush, cord to secure brush in place, hanging hook and an adhesive backed hand washing instructions decal in English and Spanish



36239



40021



40020



Standard(00)

Prod No	Description	Recommended Cleaning	Color	Pack
<b>Hand &amp; Nail Brushes</b>				
36239	3.5" Plastic Block Hand & Nail Brush	Hands & Nails	00	24 ea
40020	5" Handle Hand & Nail with Polyester Bristles	Hands & Nails	00	12 ea
40021	5" Handle Hand & Nail Brush Kit	Hands & Nails	00	12 ea
40022	36" Replacement Coiled Vinyl Security Line	—	00	12 ea
40023	Replacement Hook only for Hand & Nail Brush Pack	—	00	12 ea



# SCRUB BRUSHES

## All Purpose Utility Scrub Brushes

- Brushes offer a thick “pistol grip” block handle and short, stiff bristles for really tough cleaning
- Light-weight, break-resistant, “soak-proof” plastic handles are perfect for clean up in a foodservice environment
- Rugged construction with stapleset secure bristles
- Full color-coded products offer easy identification for tool segregation



40501C



40541



40501

Standard(00)	White(02)	Black(03)	Yellow(04)	Red(05)
Green(09)	Blue(14)	Orange(24)	Tan(25)	Purple(68)

Prod No	Description	Recommended Cleaning	Color	Pack
<b>All Purpose Utility Scrub Brushes</b>				
40541	8" Utility Scrub Brush with Polyester Bristles, 2" trim	Pots/Pan/Medium Scrubbing	02, 04, 05, 09, 14, 24, 25, 68	12 ea
40501	20" Utility Scrub Brush with Polyester Bristles, 2" trim	Pots/Pan/Medium Scrubbing	02, 03, 05*, 14*, 24, 25, 68	12 ea
40501C	20" Color-Coded, Polyester Utility Scrub Brush Polyester Bristles, 2" trim	Pots/Pan/Medium Scrubbing	02, 04, 05, 09, 14	6 ea
40545	8" Brush with Medium Stiff Polyester Bristles, 1.6" trim	Pots/Pan/Medium Scrubbing	00	12 ea
40546	8" Brush with Medium Stiff Polyester Bristles, 1.6" trim	Pots/Pan/Medium Scrubbing	02	12 ea
40542	8" Brush with Medium Stiff Nylon Bristles, 1.4" trim	Pots/Pan/Medium Scrubbing	00	12 ea
40500	20" Brush with Medium Stiff Nylon Bristles, 1.6" trim	Pots/Pan/Medium Scrubbing	00	12 ea

\*Color available by special order only

# GENERAL CLEANING BRUSHES

## General Clean-Up Brushes

- 45463, 45493 have hardwood block design with stiff palmyra bristles for heavy-duty scrubbing
- Light-weight plastic handles are break-resistant, soak-proof, sanitary and economical.



## Natural Fiber Bristles

- 45463, 45493 have solid hardwood blocks
- 8" & 20" utility scrub brushes available with palmyra or tampico bristles



Prod No	Description	Recommended Cleaning	Color	Pack
<b>Clean-Up Brushes</b>				
365015	6" Brush with Polypropylene Bristles, 1.38" trim	Pots/Pan/Medium Scrubbing	00	12 ea
36505	8.5" Brush with Polypropylene Bristles, 2" trim	Pots/Pan/Medium Scrubbing	00, 01, 14	12 ea
36505L	20" Brush with Polypropylene Bristles, 2" trim	Pots/Pan/Medium Scrubbing	00, 14	12 ea
<b>Natural Fiber Bristle Utility Scrubs</b>				
36509L	20" Utility Scrub with Tampico Bristles	General Cleaning	00	12 ea
36513	8" Utility Scrub with Palmyra Bristles	General Cleaning	00	12 ea
36513L	20" Utility Scrub with Palmyra Bristles	General Cleaning	00	12 ea
45463	8-1/2" Stiff Utility Scrub with Palmyra Bristles	Wok/Griddle	00	12 ea
45493	20" Stiff Utility Scrub with Palmyra Bristles	Wok/Griddle	00	12 ea

# COUNTER & RADIATOR BRUSHES

## Counter Top & Radiator Brushes

- Wide variety of bristle and handle choices
- 36211's flagged bristles are ideal for cleaning up fine particles and dust
- 45411 .5" Narrow Profile Radiator Brush cleans counter tops, between equipment and counter tops and refrigerated cooling coils



Standard(00)	Brown(01)	White(02)	Black(03)	Yellow(04)	
Red(05)	Green(09)	Blue(14)	Gray(23)	Orange(24)	Purple(68)

Prod No	Description	Recommended Cleaning	Color	Pack
<b>Counter Top &amp; Radiator Brushes</b>				
40480	8" Plastic Handle with White Polyester Bristles, 2.5" trim	Counters/Tables	01, 02, 04, 05, 09, 14, 24, 68	12 ea
40481	8" Plastic Handle with Black Polyester Bristles, 2.5" trim	Counters/Tables	00	12 ea
40485	8" Wood Handle with Horsehair & Polypropylene Blend Bristles, 2.5" trim	Counters/Tables	00	12 ea
36211	8" Plastic Counter Brush, 2.5" trim	Counters/Tables	23, 24	12 ea
45411	24" Radiator Brush with Horsehair-Polypropylene Bristles, 2" trim	Radiators/Narrow Areas	03	12 ea

# CLEANING CLOTHS & DUSTERS

## Microfiber Cleaning/Polishing Cloths

- 36333 is great for mirrors, windows and metallic surfaces
- 36334 is great for general cleaning



## Dusters

- 363404 features soft bristles for wall and ceiling dusting
- 45733 and 363156 duster have static active 100% lambswool; lambswool is electrostatically charged to attract lint and dust particles



Prod No	Description	Recommended Cleaning	Color	Pack
<b>Microfiber Cleaning/Polishing Cloths</b>				
36333	16" x 16" Microfiber Suede Polishing Cloth	Glass/Metalic Surfaces	14	12 ea
36334	16" x 16" Microfiber Terry Polishing Cloth	General Cleaning	02, 04, 05, 09, 14	12 ea
<b>Dusters</b>				
363404	9" Flagged Polypropylene Duster	Walls/Ceilings	14	12 ea
365450	34" – 59" Metal Telescopic Handle	Attach to 363404	00	12 ea
45733	30" – 42" Telescopic Plastic Handle with Lambswool	Vents/Blinds	00	12 ea
363156	52" – 81" Telescopic Poly Wool Duster	Vents/Blinds	00	12 ea

# HAND SQUEEGEES, SCRAPERS & DUSTERS

## Hand Held Window Squeegees

- Double blade red thermal rubber blades and zinc plated steel frame yields superior performance at an affordable price
- Single blade, black special blend rubber for a streak free professional finish. Zinc plated steel frame with a long handle socket that is easy to hold and fits a tapered handle

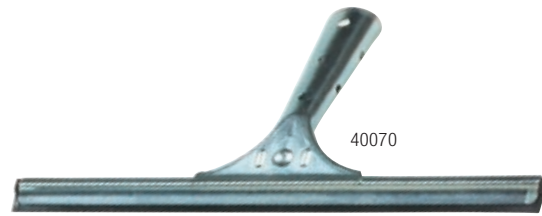

## Window Scrapers

- Professional 4" wide scrapers
- 4" scraper has one sharp edge and one dull edge



Prod No	Description	Recommended Cleaning	Color	Pack
<b>Hand Held Window Squeegees</b>				
41027	12" Double-Blade with Metal Handle	Windows	00	6 ea
40074	14" Double-Blade with Metal Handle	Windows	00	12 ea
40070	12" Single-Blade with Metal Handle	Windows	00	12 ea
40071	16" Single-Blade with Metal Handle	Windows	00	12 ea
<b>Window Scrapers</b>				
365117	Complete Scraper with 6" Plastic Handle Head & Blade	Tables/Floors/Windows	00	10 ea
365120	4" Replacement Blade Dispenser 10 per pack/10 packs per case	—	00	10 pks

## HANDLE GUIDE

Prod No	Page	Description	Type of Handle	Recommended Handle
<b>Equipment Brushes</b>				
40291	268	8.5" Oven Brush & Scraper	Threaded	40275
40293	268	10" Pizza Oven Brush	Threaded	40275
<b>Hand Squeegees</b>				
40070	275	12" Single-Blade Squeegee	Tapered	365408
40071	275	16" Single-Blade Squeegee	Tapered	365408
40074	275	14" Double-Blade Squeegee	Tapered	365408
41027	275	12" Double-Blade Squeegee	Tapered	365408



**CARLISLE**  
FOODSERVICE PRODUCTS

DURABLE  
INNOVATIVE  
VERSATILE  
**FLOOR &  
RESTROOM  
PRODUCTS**

---

*Carlisle offers durable, innovative and versatile solutions to maintain a clean and healthy environment with a complete line of brushes, brooms and mopping supplies.*



# UPRIGHT BROOMS

Carlisle's upright brooms are **designed for extended use and offer superior performance.** Whether you're sweeping a lobby, kitchen floor or parking lot, we have **a high quality solution for you.**



## Duo-Sweep® Angled

- For reaching into corners, along walls and into hard to reach areas
- Block made with tough & durable material that resists cracking, splitting and chipping
- Color coded angle brooms have one handle hole making them more hygienic and HAACP compliant
- Standard color (00) angle brooms have two handle holes; one angled, one upright

## Recycled Angle Broom

- Contains 80% recycled flagged PET bristles and 60% recycled polypropylene copolymer shroud for increased stability
- Includes 48" durable vinyl coated metal handle with swivel hanging cap for storage

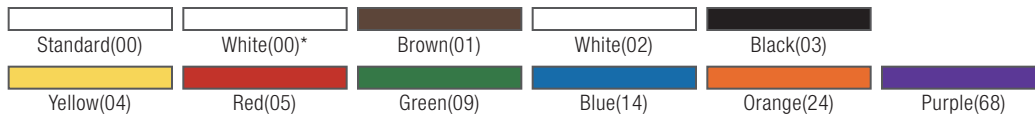

Prod No	Description	Bristle Length	Color	Pack
<b>Flagged Duo-Sweep Angle Brooms</b>				
36861	6.5" Flagged Duo-Sweep Angle Broom with 30" Metal Handle	5.5" - 7"	00	12 ea
36865	12" Flagged Duo-Sweep Medium Duty Angle Broom with 48" Metal Handle	5.5" - 7"	00	12 ea
41082	12" Flagged Duo-Sweep Broom with 48" Fiberglass Handle	5.5" - 7"	01, 02, 04, 05, 09, 14, 24, 68	12 ea
36867	12" Flagged Duo-Sweep Angle Broom – (Head Only)	5.5" - 7"	00, 01, 02, 04, 05, 09, 14, 24	12 ea
<b>Unflagged Duo-Sweep Angle Brooms</b>				
36885	12" Unflagged Duo-Sweep Heavy Duty Angle Broom with 48" Metal Handle	5.5" - 7"	00	12 ea
41083	12" Unflagged Duo-Sweep Broom with 48" Fiberglass Handle	5.5" - 7"	01, 02, 04, 05, 09, 14, 24, 68	12 ea
36868	12" Unflagged Duo-Sweep 12" Angle Broom (Head Only)	5.5" - 7"	01, 02, 03, 04, 05, 09, 14	12 ea
<b>Replacement Handles</b>				
41225	48" Fiberglass Handle with Self-Locking Flex™ Tip – 1" D	—	00*, 01, 03, 04, 05, 09, 14	12 ea
3620294	48" Plastic Coated Metal Threaded Handle – 15/16" D	—	03	12 ea
3620194	48" Powder Coated Metal Threaded Handle – 7/8" D	—	14	12ea
<b>Recycled Angle Broom</b>				
40650	12" Flagged Recycled Angle Broom with 48" Steel Handle	6" - 7"	00	12 ea





**Flagged**

Great for fine debris and use on smooth surfaces



**Unflagged**

Great for larger debris and rough surfaces: Bristles prevent ends from matting making this style perfect for back-of-house and outdoor applications

**Duo-Sweep® Straight**

- Two handle holes; upright hole for general purpose sweeping or angle hole for reaching into corners, along walls or into hard to reach areas
- Flagged blue synthetic bristle for fine debris
- Stiff black synthetic bristles can be easily cleaned to extend broom life
- Guaranteed to outlast up to four corn brooms



36859



36863



36883



36860



36864



36884



Prod No	Description	Bristle Length	Color	Pack
<b>Flagged Duo-Sweep Brooms</b>				
36859	7.5" Flagged Duo-Sweep Lobby Broom with 30" Black Metal Handle	4"	14	12 ea
36863	11" Flagged Duo-Sweep Light Industrial Broom with 48" Blue Metal Handle	4"	14	12 ea
36853	11" Flagged Duo-Sweep Light Industrial Broom (Head Only)	4"	14	12 ea
36883	13" Flagged Duo-Sweep Warehouse Broom with 48" Blue Metal Handle	7"	14	12 ea
36873	13" Flagged Duo-Sweep Warehouse Broom (Head Only)	7"	14	12 ea
<b>Unflagged Duo-Sweep Brooms</b>				
36860	7.5" Unflagged Duo-Sweep Lobby Broom with 30" Black Metal Handle	4"	03	12 ea
36864	11" Unflagged Duo-Sweep Light Industrial Broom with 48" Blue Metal Handle	4"	03	12 ea
36854	11" Unflagged Duo-Sweep Light Industrial Broom (Head Only)	4"	03	12 ea
36884	13" Unflagged Duo-Sweep Warehouse Broom with 48" Black Metal Handle	7"	03	12 ea
36874	13" Unflagged Duo-Sweep Warehouse Broom (Head Only)	7"	03	12 ea
<b>Replacement Handles</b>				
41225	48" Fiberglass Handle with Self-Locking Flex™ Tip – 1" D	—	00, 03, 04, 05, 09, 14	12 ea
3620294	48" Plastic Coated Metal Threaded Handle – 15/16" D	—	03	12 ea
3620194	48" Powder Coated Metal Threaded Handle – 7/8" D	—	14	12ea

# UPRIGHT BROOMS

## Natural Corn Blend

- Heavy-duty lacquered wood handle
- 41354 heavy-duty warehouse broom has metal retaining bands and strong synthetic stitching for long-lasting use
- 41350 janitor broom has wide fan head for greater reach



## 100% Natural Corn

- Long lasting, durable broomcorn
- Heavy-duty lacquered wood handle



Prod No	Description	Stitch	Color	Pack
<b>Natural Corn Blend Brooms</b>				
36633	10" Corn Whisk	2-Sew	00	12 ea
3682	40" Lobby Blended Corn Broom, 9#	3-Sew	00	12 ea
41349	55" Housekeeping Broom	3-Sew	67	12 ea
41352	55" Housekeeping Broom	4-Sew	00	12 ea
41350	56" Warehouse/Janitor Blended Corn Broom, 29#	5-Sew	67	12 ea
41354	56" Warehouse Blended Corn Broom, 30#	4-Sew/1-Wire	67	12 ea
<b>100% Natural Corn Broom</b>				
40634	56" Janitor Corn Broom, 26#	5-Sew	00	6 ea

## Synthetic Corn

- “X” shaped polypropylene bristles allow for superior sweeping on carpeting and entry mats
- Chemical and liquid resistant bristles; sustains temperatures to 225°F
- All, except 36634, have wooden handle
- 41679 has a foam gripped handle
- 45643 and 45649 have metal top for added durability



Prod No	Description	Stitch	Color	Pack
<b>Synthetic Corn Brooms</b>				
41679	57" Warehouse/Janitor Broom	6-Sew	03	12 ea
41680	55" Housekeeping Broom	5-Sew	03	12 ea
45649	54" Housekeeping Broom with Metal Top	Wire/Metal Top	01	6 ea
45643	48" Maid Broom with Metal Top	Wire/Metal Top	04	12 ea
41683	40" Toy/Lobby Broom	3-Sew	03	12 ea
36634	9" Plastic Corn Whisk	2-Sew	00	12 ea

# FLOOR SWEEPS

Only Carlisle offers a broad range of high quality professional floor sweeps that are durable and versatile.

**Our manufacturing and industry expertise provides advantageous features you can't find elsewhere.**

## Omni Sweep®

- Unique patented design combines the features of fine, medium and heavy floor sweeps in a convenient all-in-one design
- Effective on all types of floor surfaces
- Short, heavy bristles in front easily sweep up heavy debris
- Long, fine/medium bristles in back sweep fine dust and particles



### Angled Pitch

Fast, effective sweeping



41881 with 40225 Handle

41880 with 40225 Handle

## Sweep Complete™

- Versatile and durable floor sweep with built-in squeegee
- Comes with 60", 3-piece aluminum handle with brace
- Two handle holes extend the life of the sweep



36219618

Handles sold separately; see pages 310-311 for handle recommendation



Prod No	Description	Bristle Length	Handle	Color	Pack
<b>Omni Sweep – Plastic Block</b>					
41880	18" Omni Sweep	1.63" - 2.38"	Threaded	00	12 ea
41881	24" Omni Sweep	1.63" - 2.38"	Threaded	00	12 ea
<b>Sweep Complete Floor Sweeps</b>					
36219618	18" Sweep Complete Floor Sweep with Squeegee	3"	Threaded	14	6 ea
36219624	24" Sweep Complete Floor Sweep with Squeegee	3"	Threaded	14	6 ea

## Fine

- Recommended use: Fine powder and dust removal on polished wood, marble, terrazzo or ceramic tile floors
- Heavy-duty plastic block resists splitting and cracking and is unaffected by moisture
- Soft, flagged bristles



36204824

## Medium

- Recommended use: For general sweeping of smooth concrete, unpolished wood, vinyl and tile floors
- Heavy-duty plastic blocks resist splitting and cracking and are unaffected by moisture
- Horsehair polypropylene is a perfect blend of soft bristles for fine dust and stiff bristles for heavier debris
- Use black natural tampico bristles for heavy dirt
- Black polypropylene bristles resist oil and water while maintaining shape



40562

Handles sold separately; see pages 310-311 for handle recommendation



Prod No	Description	Handle	Color	Pack
<b>Fine Floor Sweeps</b>				
36204818	18" Foam Block with Gray Polypropylene, 3" trim	Tapered	23	12 ea
36204824	24" Foam Block with Gray Polypropylene, 3" trim	Tapered	23	12 ea
<b>Medium Floor Sweeps</b>				
40564	18" Foam Block with Black Tampico, 3" trim	Tapered	00	12 ea
40565	24" Foam Block with Black Tampico, 3" trim	Tapered	00	12 ea
40561	18" Foam Block with Horsehair-Polypropylene Blend, 3" trim	Tapered	00	12 ea
40562	24" Foam Block with Horsehair-Polypropylene Blend, 3" trim	Tapered	00	12 ea
362208P18	18" Foam Block with Black Polypropylene, 3" trim	Tapered	03	12 ea
362208P24	24" Foam Block with Black Polypropylene, 3" trim	Tapered	03	12 ea

# FLOOR SWEEPS

## Heavy

- Recommended Use: Outdoors on rough surfaces such as sidewalks and parking lots
- For wet or dry sweeping
- Polypropylene (PPY) bristles are stiff and long lasting under harsh conditions. PPY bristles resist oil and water making them ideal for back-of-house cleaning
- Palmyra bristles are medium stiff and long lasting under harsh conditions
- Plastic blocks are extremely durable and resist water, cracking, splitting and chipping
- Wood blocks are made with natural lacquered hardwood

Plastic Block



36207218

Wood Block



45222

367618

367624

Handles sold separately; see pages 310-311 for handle recommendation



Prod No	Description	Handle	Color	Pack
<b>Heavy Floor Sweeps</b>				
36207218	18" PPY Sweep, Foam Block, 3.25" trim	Tapered	00	12 ea
	24" PPY Sweep, Foam Block, 3.25" trim	Tapered	00	12 ea
45222	24" Palmyra Sweep with Hardwood Block, 3.5" trim	Threaded/Tapered	00	12 ea
367618	18" PPY Sweep, Hardwood Block, 3.25" trim	Threaded/Tapered	24	12 ea
367624	24" PPY Sweep, Hardwood Block, 3.25" trim	Threaded/Tapered	24	12 ea

# DUSTPANS & SWEEPERS

## Lobby Pan & Broom Combos

- Lobby pans and brooms with sectional handles to give you over 50% reduction in carton size; lower cube saves warehouse space and shipping costs
- The lobby pans pivot and lock into place during use and release for easy carrying or emptying
- Handles feature a pivoting hanging hole at top for storage

### 361415 Combo includes the following:

- Serrated edge allows you to comb the broom's bristles and drop debris into the pan
- Handy clip to attach broom for convenient storage
- 30" two-piece handle made from vinyl coated steel

### 361416 Combo includes the following:

- Adjustable position head for more functional use in corners and under counters or tables
- 3 piece, 30" handle
- Handy clip to attach broom for convenient storage
- Shelf-friendly packaging



Black(03)

Prod No	Description	Material	Style	Color	Pack
<b>Lobby Pan &amp; Broom Combos</b>					
361415	Duo-Pan™ Lobby Pan & Duo-Sweep Broom Combo	Plastic	Lobby	03	1 ea
361412	Broom Handle Clip for 361415	—	—	03	12 ea
361416	Duo-Pan™ II Lobby Pan & Broom Combo	Plastic	Lobby	03	4 ea

# DUSTPANS & SWEEPERS

## Dust & Lobby Pans

- Dust Pans are available in metal or plastic as well as in a “flip-up” lobby style or hand held
- Dust pan (361437) features a 90° threaded handle hole to convert it to an economy lobby dustpan
- 361420 features a 2 piece handle which reduces the carton size saving warehouse space and shipping costs
- 361420 has plastic edged teeth on the bail which allows you to comb through broom bristles to remove debris



## Floor Sweepers

- Brushless mechanical sweeper has non-marking rubber blades that grab fine particles and heavy debris from various types of floor surfaces
- Large capacity dust bins thoroughly clean blades as they rotate; won't re-deposit dirt like ordinary sweepers
- Easy one touch doors for emptying debris
- Shelf-friendly packaging



Prod No	Description	Material	Style	Color	Pack
<b>Dust &amp; Lobby Pans</b>					
361420	12" Wide Lobby Dust Pan with 2-Piece 30" Handle	—	Lobby	03	1 ea
361437	12" Wide Rubberized Plastic Dustpan	Plastic	Hand-Held	03	24 ea
36236	12" Metal Dustpan	Heavy Gauge Steel	Hand-Held	03	12 ea
361410	12" Duo-Pan™ Plastic Lobby Pan with 30" Metal Handle	Plastic	Lobby	03	6 ea
36141003-1	12" Duo-Pan™ Plastic Lobby Pan with 30" Metal Handle	Plastic	Lobby	—	1 ea
<b>Floor Sweepers</b>					
36399	9.5" Multi-Surface Sweeper	—	—	14	4 ea
36400	12" Multi-Surface Sweeper	—	—	14	4 ea



# FLOOR SCRUB BRUSHES

## Dual Surface Brushes

- Recommended use: Cleaning kitchen floors, under counters, around equipment and along baseboards
- Floor scrubs are made with three different brush surfaces for cleaning at different angles
- Non-absorbent plastic blocks and synthetic bristles wash easily and prevent gathering of mold and mildew



## Scrub Brushes

- Recommended use: Cleaning kitchen floors, under counters, around equipment and along baseboards
- Polypropylene (PPY) bristles are stiff and long lasting under harsh conditions. PPY bristles resist oil and water making them ideal for back-of-house cleaning
- Tampico bristles provide durability and high resistance to solvents and heat
- Palmyra bristles are medium stiff and long lasting under harsh conditions
- Natural wood block



Handles sold separately; see pages 310-311 for handle recommendation

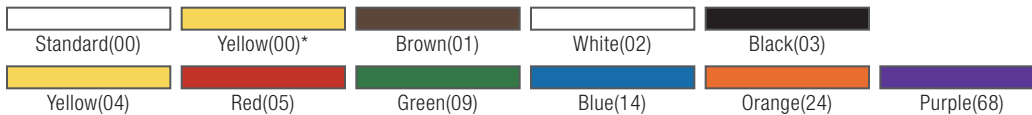

Prod No	Description	Handle	Color	Pack
<b>Dual Surface Brushes</b>				
40423	10" Hi-Lo Floor Scrub Brush	Threaded	01, 02, 03, 04, 05, 09, 24, 68	12 ea
36197	10" Dual Surface Scrub Brush	Threaded	14	12 ea
36190	10" Dual Surface Scrub Brush with Squeegee	Threaded	14	12 ea
40422	10" Dual Surface Scrub Brush with End Bristles	Threaded	00*, 05, 09, 14	12 ea
<b>Floor &amp; Deck Scrub Brushes</b>				
36175	10" Wood Block with Stiff Polypropylene Bristles	Threaded/Tapered	14	12 ea
36275	12" Wood Block with Stiff Polypropylene Bristles	Threaded/Tapered	14	12 ea
36193	10" Wood Block with Tampico Bristles	Threaded/Tapered	00	12 ea
36192	10" Wood Block with Palmyra Bristles	Threaded/Tapered	00	12 ea
36292	12" Wood Block with Palmyra Bristles	Threaded/Tapered	00	12 ea

# FLOOR SCRUB BRUSHES

## Swivel Floor Brushes

- Patented\* design swivels onto side to clean baseboards, walls, around kitchen equipment and other hard to reach areas

\*U.S. Patent No. 4763377



## Scrub Pads & Holder

- Swivel pad holder is great for cleaning baseboards, floor edges, underneath fixtures and ceramic tile



Handles sold separately; see pages 310-311 for handle recommendation



Prod No	Description	Handle	Color	Pack
<b>Swivel Floor Brushes</b>				
365300*	8" Heavy-Duty Daily Swivel Scrub with Nylon Grit Bristles	Threaded	14	12 ea
365310*	8" Swivel Scrub with Heavy Nylon Grit Bristles	Threaded	27	12 ea
40430	9" All-Around Scrub Brush with Stiff Polypropylene Bristles	Threaded	00*	12 ea
36219663	8" Polypropylene-Fill Swivel Scrub with 48" Handle	—	00	4 ea
<b>Scrub Pads &amp; Holder</b>				
40724	10" x 4-5/8" x 1" Nylon Fine Scrub Pad, 5 ea/pack, 4 pks/case	—	00	4 pks
40725	10" x 4-5/8" x 1" Nylon Medium Scrub Pad, 5 ea/pack, 4 pks/case	—	00	4 pks
365380	Swivel Pad Holder	—	14	12 ea

# GROUT BRUSHES & FLOOR SQUEEGEES

## Tile & Grout Brushes

- 365320 has bevel cut stiff crimped nylon bristles and a swivel head for hard to reach areas
- 41323 features a molded in scraper for tough dirt and grime and can be hand held or used with a threaded handle. Base resins for block and bristles are FDA compliant



## Double Foam Squeegees with Metal Frame

- Rugged black neoprene for heavy-duty removal of dirt, water and debris on uneven surfaces
- Medium flexibility and non-marking

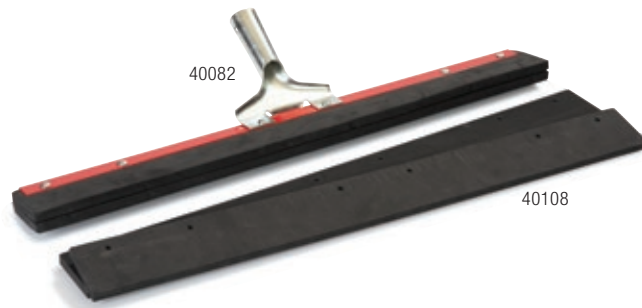

Handles sold separately; see pages 310-311 for handle recommendation

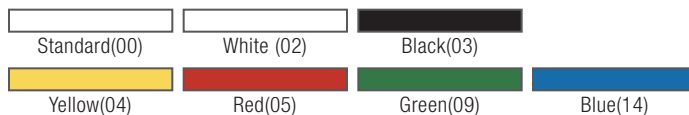

Prod No	Description	Handle	Color	Pack
<b>Tile &amp; Grout Brushes</b>				
365320	7.5" Swivel Head Grout Line Brush, Nylon Bristle	Threaded/Tapered	03	12 ea
365351	8.5" Grout Brush, Nylon Bristle	—	03	24 ea
41323	9" Tile & Grout Brush	Threaded	02, 04, 05, 09, 14	12 ea
<b>Double Foam Squeegees with Metal Frame</b>				
40081	18" Double Foam Neoprene Rubber	1.13" Tapered	00	6 ea
40082	24" Double Foam Neoprene Rubber	1.13" Tapered	00	6 ea
40083	30" Double Foam Neoprene Rubber	1.13" Tapered	00	6 ea
40107	18" Double Foam Neoprene Rubber Refill	—	00	12 ea
40108	24" Double Foam Neoprene Rubber Refill	—	00	12 ea
40109	30" Double Foam Neoprene Rubber Refill	—	00	12 ea

# FLOOR SQUEEGEES

## Double Moss Foam Rubber with Metal Frame

- Moss Foam squeegee is designed for uneven, grouted and smooth surface floors
- Red Moss Foam is fat and oil resistant



## Double Foam Rubber Squeegee with Plastic Frame

- All plastic construction will not rust or bend and helps prevent hazard sparks when cleaning-up flammable fluids
- Available in colors to support HACCP compliance
- For uneven or smooth surfaces



## Double Moss Foam Rubber Squeegee with Plastic Frame

- Soft, double foam is fat and oil resistant
- All plastic construction will not rust or bend and helps prevent hazard sparks when cleaning-up flammable fluids
- For uneven or smooth surfaces

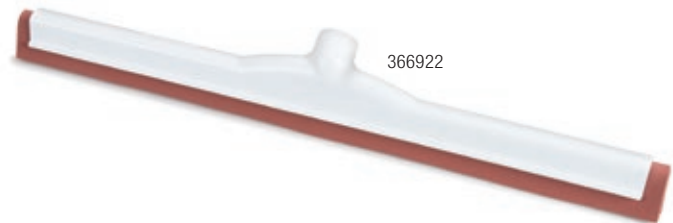

Handles sold separately; see pages 310-311 for handle recommendation

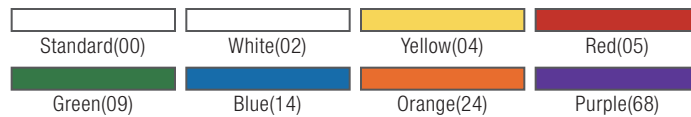

Prod No	Description	Handle	Color	Pack
<b>Double Moss Foam Rubber with Metal Frame</b>				
366318	18" Soft Black Foam Rubber	.94" Tapered	00	10 ea
366324	22" Soft Black Foam Rubber	.94" Tapered	00	10 ea
366824	22" Soft Black Heavy-Duty Foam Rubber	Threaded	00	10 ea
366330	30" Reinforced Soft Black Foam Rubber	.94" Tapered	00	10 ea
<b>Double Foam Rubber Squeegee with Plastic Frame</b>				
41567	18" Double Foam Rubber Floor Squeegee	Threaded	02, 04, 05, 09, 14, 24, 68	6 ea
41568	24" Double Foam Rubber Floor Squeegee	Threaded	02, 04, 05, 09, 14, 24, 68	6 ea
<b>Double Moss Foam Rubber Squeegee with Plastic Frame</b>				
366918	18" Red Foam Rubber	.94" Threaded	00	10 ea
366922	22" Red Foam Rubber	.94" Threaded	00	10 ea

### Double Foam Rubber Squeegee & Brush with Plastic Frame

- Use the brush side to remove stubborn debris and the squeegee side to dry the floor
- All plastic construction will not rust or bend and helps prevent hazard sparks when cleaning-up flammable fluids

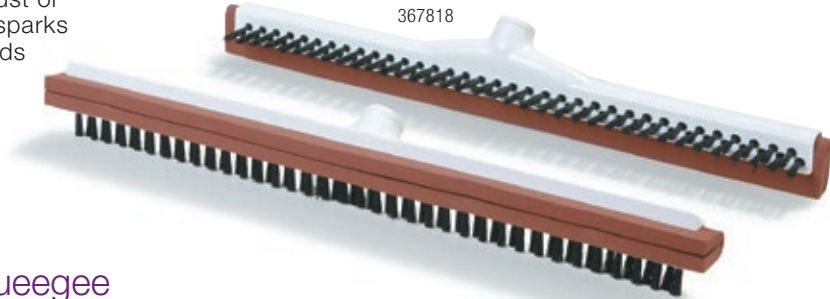

### Curved End Rubber Squeegee with Metal Frame

- Single rubber blade design
- Curved end controls liquid better
- For smooth surfaces
- Red gum rubber is non-marking and durable for heavy-duty use



### One-Piece Rubber Squeegee with Plastic Frame

- All plastic construction will not rust or bend and helps prevent hazard sparks when cleaning-up flammable fluids
- Available in colors to support HACCP compliance
- For smooth surfaces



Handles sold separately; see pages 310-311 for handle recommendation

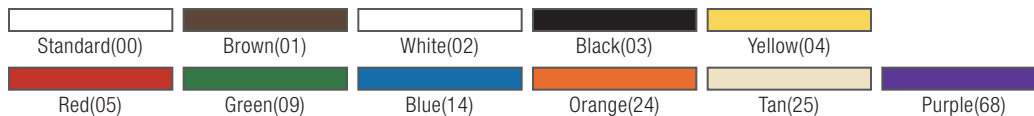

Prod No	Description	Handle	Color	Pack
<b>Double Foam Rubber/Brush with Plastic Frame</b>				
367818	18" Red Double Foam Red Rubber	Threaded	00	10 ea
<b>Single Curved End Rubber Squeegee with Metal Frame</b>				
36324C	24" Curved End Black Rubber Squeegee	1.13" Tapered	00	6 ea
36336C	36" Curved End Black Rubber Squeegee	1.13" Tapered	00	6 ea
<b>One-Piece Rubber Squeegee with Plastic Frame</b>				
36567	20" Solid, One-Piece Rubber Squeegee	Threaded	01, 02, 03, 04, 05, 09, 14, 24, 25, 68	6 ea
36568	24" Solid, One-Piece Rubber Squeegee	Threaded	01, 02, 03, 04, 05, 09, 14, 24, 68	6 ea

# FLOOR SQUEEGEES

## Straight Rubber Squeegee with Metal Frame

- Durable construction
- Non-marking single red gum rubber blade with medium flexibility
- Heavy duty steel frame with red powder coating



40076

## VersaClean™ Brush & Squeegee

- It's a broom, scrub brush and squeegee all in one! Can be used on wet or dry surfaces
- Unique non-marking synthetic rubber bristles can build electrostatic charge to pick up hair or other light debris from soft or hard floor surfaces
- Durable bristles are excellent for scrubbing
- Dishwasher safe making it one of the most hygienic broom and brush options on the market
- Resists most chemicals and withstands temperatures up to 212°F



36592

36596



Squeegee cleans up wet surfaces quickly



Picks up light debris from carpet, rugs or bare floors



Use as an agitator for stubborn spots on tile or concrete



Built-in one-piece squeegee works on rough concrete surface

Handles sold separately; see pages 310-311 for handle recommendation



Prod No	Description	Handle	Color	Pack
<b>Single Straight Rubber Squeegee with Metal Frame</b>				
40075	18" Straight Red Gum Squeegee	1.13" Tapered	00	6 ea
40076	24" Straight Red Gum Squeegee	1.13" Tapered	00	6 ea
40077	36" Straight Red Gum Squeegee	1.13" Tapered	00	6 ea
<b>VersaClean Brush &amp; Squeegee</b>				
36592	VersaClean Brush with Squeegee	Threaded	03	12 ea
36596	VersaClean Brush with Squeegee	Threaded	03	12 ea

# HANDLES

Carlisle offers a **large selection of professional quality handles** that include fiberglass, plastic, metal, hardwood and telescoping.

## Color-Coded Fiberglass Handles

- Durable for heavy usage
- For use with push brooms, sweeps, squeegees and floor scrubs
- Fiberglass handles are available in threaded, tapered/threaded and telescoping
- Self-Locking Flex-Tip Handle offers greater flexibility and reduces handle stress

## Color-Coded Stainless Steel Handle

- Durable for heavy usage
- Color-Coded grip aligns with food safety (HACCP)
- Provide rigid stability
- Highly chemical resistant
- Standard threaded end

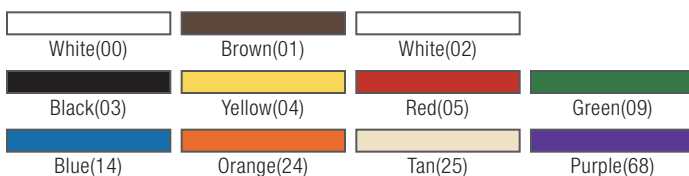

Prod No	Description	Dia	Style	Color	Pack
<b>Color-Coded Fiberglass Handles</b>					
41226	72" Fiberglass Handle with Self-Locking Flex-Tip	1"	Threaded	00	12 ea
41225	48" Fiberglass Handle with Self-Locking Flex-Tip	1"	Threaded	00, 04, 05, 09, 14	12 ea
41291	36" Fiberglass Handle with Self-Locking Flex-Tip	1"	Threaded	00	12 ea
40225	60" Fiberglass Handle with Self-Locking Flex-Tip	1"	Threaded	01, 02, 03, 04, 05, 09, 14, 24, 25, 68	12 ea
40227	60" Solid Foam Filled Fiberglass Handle with Self-Locking Flex-Tip	1"	Tapered/Threaded	02, 04, 05, 09, 14	12 ea
40220	60" Fiberglass Handle	1"	Tapered/Threaded	01, 02, 04, 05, 09, 14	12 ea
40210	60" Economy Fiberglass Handle	.94"	Female Threaded	02, 04, 05, 09, 14	12 ea
41020	54" to 8' Threaded Telescoping Fiberglass Handle	1"	Threaded Telescoping	01*, 02, 04, 05, 09, 14	12 ea
<b>Color-Coded Stainless Steel Handle</b>					
41199C	60" Stainless Steel Handle with Grip	1"	Threaded	02, 04, 05, 09, 14	6 ea

FIBERGLASS

STAINLESS STEEL



\*Color available by special order only

# HANDLES



STEEL

METAL

PLASTIC

TELESCOPIC

## Steel Handles

- Heavy-duty stainless steel handles are highly chemical resistant
- For use with caustic chemicals or in a sanitary food processing environment
- Highly durable alternative to fiberglass

## Coated Metal Handles

- Lightweight and economical
- Plastic hanging cap

## Plastic Handles

- A variety of sizes with reinforced threaded tip
- For light usage

## Telescopic Handles

- Adjusts quickly to desired length
- Standard threaded end
- Ideal for window brushes and squeegees

## 3-Piece Aluminum Handle

- Utilizes metal y-connectors to secure sections
- Compact size saves on shipping costs
- Shelf-ready packaging

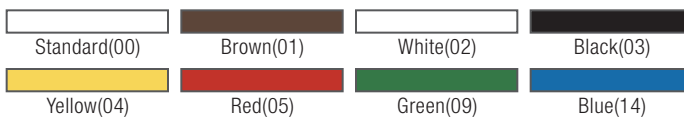

Prod No	Description	Dia	Style	Color	Pack
<b>Steel Handles</b>					
45259	60" Steel Handle	.94"	Threaded	00	12 ea
<b>Coated Metal Handles</b>					
3620194	48" Light Weight Powder Coated Metal Handle with Plastic Tip	.88"	Threaded	14	12 ea
3620294	48" Plastic Coated Metal Handle	.94"	Threaded	03	12 ea
<b>Telescopic Handles</b>					
365408	54" to 8' Aluminum Telescopic Handle with Locking Joints	1"	European Tapered/ Standard Threaded	00	10 ea
41020	54" to 8' Fiberglass Telescopic Handle	1"	Threaded	01*, 02, 04, 05, 09, 14	12 ea
<b>3-Piece Aluminum Handle</b>					
40224	60" 3-Piece Aluminum Handle with Standard Thread	1"	Threaded	00	12 ea
<b>Plastic Handles</b>					
40230	36" Plastic Handle with Reinforced Tip	1"	Threaded	00	12 ea
40233	48" Plastic Handle with Reinforced Tip	1"	Threaded	00	12 ea
40232	60" Plastic Handle with Reinforced Tip	1"	Threaded	00	12 ea

\*Color available by special order only



## Wood Handles

- Made of lacquered hardwood
- Available in a large selection of standard threaded and tapered styles
- Economical choice

WOOD



## Dust Mop Handles

- Available in wood, coated metal and fiberglass
- 360° movement for fast and easy cleaning

DUST MOP



Standard(00)	White(02)	Black(03)
Yellow(04)	Red(05)	Green(09)
Blue(14)	Orange(24)	Purple(68)

Prod No	Description	Dia	Style	Color	Pack
<b>Wood Threaded Handles</b>					
40271	60" Wood Handle	.94"	Threaded	00	12 ea
40267	60" Wood Handle	1.13"	Threaded	00	12 ea
<b>Metal Threaded Handles</b>					
40275	40" Metal Tip Wood Handle	.88"	Metal Thread	00	12 ea
45267	60" Wood Handle with Metal Tip	.94"	Metal Thread	00	12 ea
<b>Tapered Handles</b>					
40261	54" Wood Handle	1.13"	Tapered	00	12 ea
40262	60" Wood Handle	1.13"	Tapered	00	12 ea
<b>Dust Mop Handles</b>					
45850	60" Wood Dust Mop Handle with Clip-On Connector	.94"	—	00	12 ea
362013	60" Vinyl Coated Metal Dust Mop Handle with Clip-On Connector	.94"	—	00	12 ea
<b>Fiberglass Dust Mop Handles</b>					
362113	60" Fiberglass Dust Mop Handle	1"	—	02, 03, 04, 05, 09, 14, 24, 68*	12 ea

\*Color available by special order only

# HANDLE ACCESSORIES

## Roll 'N Grip™ Broom & Brush Holder System

- Adjustable rack holds a variety of different handle diameters
- Comes with a convenient hook for tools and brushes (additional hooks and grippers are available by special order)
- Rack anchor holes are 16" on center (mounting screws included)



## Roll 'N Grip Plus

- Constructed of light-weight, durable ABS and rubber
- Fold-up hanging hooks for smaller items
- For use in temperatures from -4°F to 176°F
- Grips accommodate items from 5/8" - 1-1/4" in diameter and 0.4 - 8.25 lbs
- Hanging hooks can hold up to 1.5 lbs each



## Color-Coded Brush Rack

- Heavy-gauge aluminum
- Extra deep (2-1/4") frame extends out from wall to allow brushes to hang with bristles facing the wall
- Holds up to 10 hanging tools
- Mounting holes are 16" on center (mounting screws included)
- Available in 5 colors to support HACCP compliance



Prod No	Description	Color	Pack
<b>Roll 'N Grip Broom &amp; Brush Holder System</b>			
40731	18" Roll 'N Grip Broom & Brush Holder System	00	12 ea
40732	Roll 'N Grip Replacement Roller (2 per pack) with 4 Wood Screws	00	12 pk
40733	Roll 'N Grip Replacement Hooks (2 per pack) with 4 Wood Screws	00	12 pk
<b>Roll 'N Grip Plus</b>			
40737	16-1/2" Roll 'N Grip Plus Broom & Brush Holder	00	24 ea
<b>Color-Coded Brush Rack</b>			
40735	17" Brush Rack	00*, 04, 05, 09, 14	12 ea

# MICROFIBER SYSTEM & DUST MOPS

## Microfiber Dry Mop

- Looped end with microfiber center clings to dust like a magnet
- Quickly attaches itself to aluminum head
- Machine washable



## Microfiber Wet Mop

- Dries quicker, cleans more thoroughly than a standard mop
- Machine washable and still effective with over 500 washings
- Quickly attaches itself to aluminum head



## Aluminum Flat Mop Heads & Telescoping Handle For Microfiber

### Mop Heads

- Heavy duty construction and swivel mechanism
- For use with wet and dry microfiber flat mops

### Handle

- 70" telescopic handle for use with aluminum flat mop heads



Handles sold separately



Prod No	Description	Handle	Color	Pack
<b>Microfiber Dry Mops</b>				
3633118	18" Microfiber Dry Mop Pad	3633670	14	12 ea
3633124	24" Microfiber Dry Mop Pad	3633670	14	12 ea
3633136	36" Microfiber Dry Mop Pad	3633670	14	12 ea
<b>Microfiber Wet Mops</b>				
3633218	18" Microfiber Wet Mop Pad	3633218	04, 05, 09, 14	12 ea
3633224	24" Microfiber Wet Mop Pad	3633218	14	12 ea
<b>Aluminum Flat Mop Heads</b>				
3633519	18" Aluminum Flat Mop Head	3633670	00	12 ea
3633525	24" Aluminum Flat Mop Head	3633670	00	12 ea
3633537	36" Aluminum Flat Mop Head	3633670	00	12 ea
<b>Telescoping Handle</b>				
3633670	70" Aluminum Telescopic Handle	—	00	12 ea

# MICROFIBER SYSTEM & DUST MOPS

## Microfiber Charging Bucket

- Rectangular bucket with 6 gallon capacity
- Includes snap-on lid and clip-on plastic sleeve for window washers and squeegees
- Molded-in graduations
- Ergonomic handle for easy transportation



3633019

## Tie Back Dust Mops & Frames

- An economical choice for a cotton dust mop with full tie back
- Frame is constructed of heavy gauge metal
- Zinc plating reduces rust and corrosion



3647524

41672

## Wedge Dust Mop

- Cotton dust mop with frame
- Threaded handle hole
- For hard-to-reach areas



36490

Handles sold separately; see pages 310-311 for handle recommendation



Prod No	Description	Handle	Color	Pack
<b>Rectangular Microfiber Bucket</b>				
3633019	6 gal Rectangular Microfiber Bucket	—	23	3 ea
<b>Value Line Tie Back Dust Mops</b>				
3647524	24" Dust Mop, Fits 5" Wide Frame	—	00	12 ea
3647536	36" Dust Mop, Fits 5" Wide Frame	—	00	12 ea
3647548	48" Dust Mop, Fits 5" Wide Frame	—	00	12 ea
<b>Wedge Dust Mop</b>				
36490	Wedge Dust Mop	Threaded	00	12 ea
36490R	Wedge Mop Replacement	Threaded	00	12 ea
<b>Dust Mop Frames</b>				
41672	24" Mop Frame, 5" Wide	Clip-On/Flexible	00	12 ea
41673	36" Mop Frame, 5" Wide	Clip-On/Flexible	00	12 ea
3647248	48" Mop Frame, 5" Wide	Clip-On/Flexible	00	12 ea

# WET MOPPING GUIDE

Use the guide below to help choose the right products for your floor care needs.

## General Mopping

Choose mops with high absorbency, release and durability. If laundering facilities are available, it is beneficial to take advantage of launderable mops to save money. For performance and durability choose a synthetic blend or rayon mop with looped end and woven tailbands.

## Yarn

- It is important to choose the right mop in order to get maximum efficiency
- Some yarns naturally perform specific cleaning tasks better than others

## Yarn Ply

- Yarn ply is the number of strands twisted together to make a single yarn strand
- Although more plies give added strength, it does not always mean higher quality yarn
- More strands can add durability, but they decrease absorbency
- It is better & more cost effective to choose a higher quality yarn than a high ply, low-quality yarn

## Twist

- The “twist” of a yarn is a result of how tightly the fiber strands are wound together
- A tightly twisted yarn might have more strength & last longer, but it can have less absorbency
- The best choice is determined by the type & quality of the yarn, as well as the mop’s construction
- Mops with looped-end construction allow the yarn to have a loose twist without the fraying

## Finish Mopping

For finish mopping applications look for a rayon or synthetic mop. These mops offer high absorbency and release. To make sure you are achieving maximum floor coverage with minimal streaking choose a tailband and looped end yarn.

	Advantages	Disadvantages	Use
<b>Cotton</b>	Good absorption & retention with limited shrinkage & a low initial cost.	Break-in period required. Slow drying yarn leads to mildew & deterioration. Lints.	Designed for general use. Scrubbing & cleaning up liquids.
<b>Synthetic</b>	Long stable fiber offers excellent tensile strength without linting.	Higher cost. Poor absorption.	Rough surfaces.
<b>Cotton Synthetic Blend</b>	Excellent choice for performance, price & durability. Synthetic fiber offers durability & color options.	Possible shrinkage.	Requested by professionals who require a better, longer lasting mop.
<b>Rayon</b>	Absorbs quickly with easy release. Dries fast & is mildew resistant. Cleaner yarn with less linting.	Shrinks when laundered and has less liquid retention.	Use for applying liquids such as disinfectant or floor finishes.



## Band Styles



**Wide Band**  
Vinyl coated mesh – 5" width



**Narrow Band**  
Textured polyester tape – 1.25" width



**Screw Top**  
Textured polyester tape with a metal screw on attachment – 1.25" width

## Handle — Jaw Style



## Handle — Quick Change/Release



## Handle — Screw In



# WET MOPPING GUIDE

Use the guide below to help choose the right products for your floor care needs.

## Cut-End Or Looped-End



### Cut-End

- Cut-end mops are the most popular
- Low purchase price compared to looped end
- Cannot be laundered
- Cover less area per pass when mopping

### Looped-End

- Superior performance and lasts longer than cut-end mops
- Launderable
- Tailband style gives better mopping coverage
- Looped-ends prevent fraying and unraveling so you can achieve reduced labor costs and replace mops less often
- Although the initial investment is more than a cut-end style, the life expectancy makes looped-end mops a more economical choice

## How We Rate Our Mops

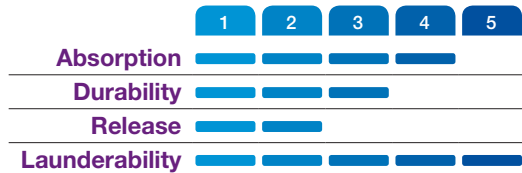

### Absorbency

The absorbency of a mop refers to the ability to pick up and retain liquid. Higher levels allow faster floor drying times, leading to greater productivity and safety. Rayon and cotton yarns have the highest absorbency.

### Durability

Mop durability is a measure of how long it will last or perform before needing replacement. Synthetic and blended mops are the most durable.

### Release/Retention

Release is the ability of a mop to disperse liquid onto the floor or during wringing. Higher levels allow faster and more complete wringing, as well as more efficient application of cleaning solutions on the floor.

### Launderability

The launderability is based on the number of washing cycles it can withstand before the construction of the mop is degraded. Synthetic and blended fiber mops have the highest levels of launderability.

## Sizes Are Indicated By Tailband Color

Small



Medium



Large



X-Large



### Brick Packs

Mops that are available in brick packs reduce cube up to 62%

(Item numbers ending with a "B" are sold in brick packs)



# LOOPED END MOPS

## Synthetic/Cotton Blend Looped-End

- Maximum Durability
- 50-75 uses per mop
- S, M and L are available in brick packs

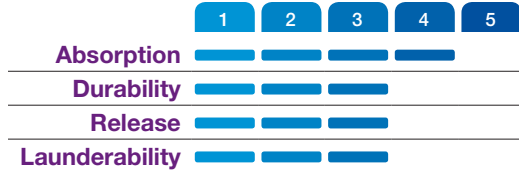

## 4 Ply Cotton Looped-End

- All purpose for general cleaning
- Packaged in brick packs

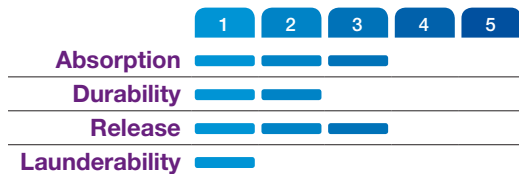

Handles sold separately; see pages 310-311 for handle recommendation



Prod No	Description	Handle	Color	Pack
<b>Synthetic/Cotton Blend (Wide Band)</b>				
369412B	Small Yellow Wide Band Mop with White Yarn	Jaw Style	00	12 ea
369442B	Small Yellow Wide Band Mop with Blue Yarn	Jaw Style	14	12 ea
369472B	Small Yellow Wide Band Mop with Green Yarn	Jaw Style	09	12 ea
369418B	Medium Green Wide Band Mop with White Yarn	Jaw Style	00	12 ea
369448B	Medium Green Wide Band Mop with Blue Yarn	Jaw Style	14	12 ea
369478B	Medium Green Wide Band Mop with Green Yarn	Jaw Style	09	12 ea
369424B	Large Red Wide Band Mop with White Yarn	Jaw Style	00	12 ea
369454B	Large Red Wide Band Mop with Blue Yarn	Jaw Style	14	12 ea
369484B	Large Red Wide Band Mop with Green Yarn	Jaw Style	09	12 ea
369430	X-Large Blue Wide Band Mop with White Yarn	Jaw Style	00	12 ea
369460	X-Large Blue Wide Band Mop with Blue Yarn	Jaw Style	14	12 ea
<b>4-Ply Cotton (Wide Band)</b>				
369551B	Medium Green Band Looped-End Mop	Jaw Style	00*	12 ea
369552B	Large Red Band Looped-End Mop	Jaw Style	00*	12 ea
<b>4 Ply Cotton (Narrow Band)</b>				
369419B	Medium Green Band Looped-End Mop	Quick Release/Quick Change	00*	12 ea
369425B	Large Red Band Looped-End Mop	Quick Release/Quick Change	00*	12 ea

# LOOPED END & CUT END MOPS

## Microfiber Looped-End

- Microfiber mop combines the absorbency and durability of microfiber with conventional mop design and functionality
- Washable mop dries quickly and is still effective with 500 washings
- See pages 297-298 for a complete list of microfiber products

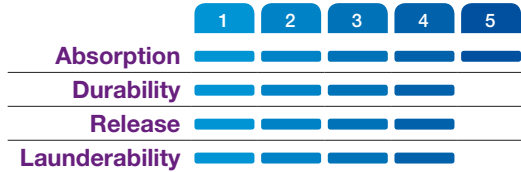

## Rough Surface Looped-End

- 17 oz knitted fleece provides twice the absorbency of cotton yarn mops
- Excellent for abrasive surfaces: stone, quarry, tile and concrete

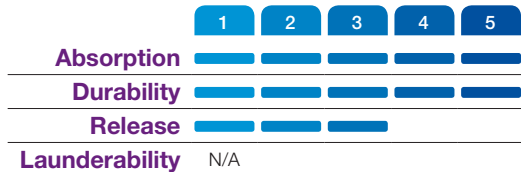

## Rayon Blend Finishing Looped-End

- Durable 4-ply rayon blend has narrow band
- Releases liquid faster than a conventional mop for a smoother finish
- Brick packed

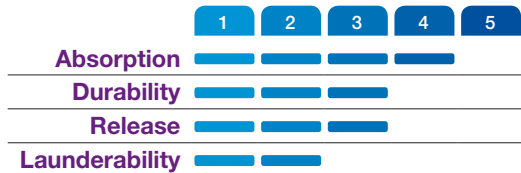

Handles sold separately; see pages 310-311 for handle recommendation



Prod No	Description	Handle	Color	Pack
<b>Microfiber (Wide Band)</b>				
369420	Medium Loop End Microfiber Mop	Jaw Style	02, 14	12 ea
<b>Rough Surface (Narrow Band)</b>				
369320	Medium Looped-End Rough Surface Mop	Quick Release/Quick Change	00	12 ea
<b>4 Ply Rayon Blend Finishing (Wide Band)</b>				
369670B	#20 Medium Finishing Looped-End Mop	Quick Release/Quick Change	14	12 ea
369674B	#24 Large Finishing Looped-End Mop	Quick Release/Quick Change	14	12 ea



## 4 Ply Cotton Cut-End

- Economical choice for general mopping
- Brick packed

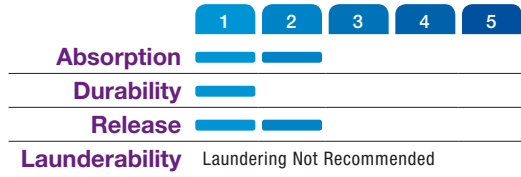

## 8 Ply Cotton Cut-End

- Abrasion-resistant, long lasting 8 ply cotton
- Best for general purpose cleaning

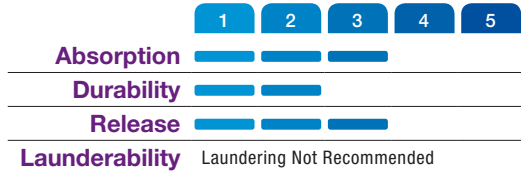

Handles sold separately; see pages 310-311 for handle recommendation

Standard(00)

Prod No	Description	Handle	Color	Pack
<b>4 Ply Cotton (Narrow Band)</b>				
369816B	#16 Small Cut-End Mop	Quick Release/Quick Change	00	12 ea
369820B	#20 Medium Cut-End Mop	Quick Release/Quick Change	00	12 ea
369824B	#24 Large Cut-End Mop	Quick Release/Quick Change	00	12 ea
369832	#32 X-Large Cut-End Mop	Quick Release/Quick Change	00	12 ea
<b>4 Ply Cotton (Wide Band)</b>				
369811B	#16 Small Cut-End Mop	Jaw Style	00	12 ea
369814B	#20 Medium Cut-End Mop	Jaw Style	00	12 ea
369817B	#24 Large Cut-End Mop	Jaw Style	00	12 ea
369819B	#32 X-Large Cut-End Mop	Jaw Style	00	12 ea
<b>8-Ply Cotton (Narrow Band)</b>				
369724	#24 Select Cut-End Mop	Quick Release/Quick Change	00	12 ea
369732	#32 Select Cut-End Mop	Quick Release/Quick Change	00	12 ea

# CUT END MOPS

## 4 Ply Rayon Cut End

- Easy to change mop heads lie flat for more efficient mopping
- 40345 Kwik-On wood handle (sold separately) attaches securely to Kwik-On mop head with a counter-sunk, reinforced thread



369074B

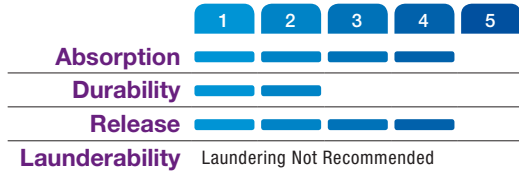

## Kwik-On™ Screw Top

- Easy to change mop heads lie flat for more efficient mopping
- 40345 Kwik-On wood handle (sold separately) attaches securely to Kwik-On mop head with a counter-sunk, reinforced thread



369024R

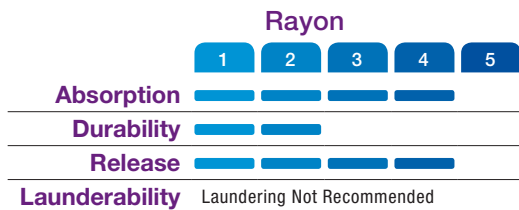
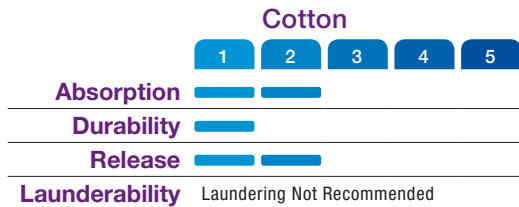

Handles sold separately; see pages 310-311 for handle recommendation



40345

Standard(00)

Prod No	Description	Handle	Color	Pack
<b>4-Ply Rayon (Narrow Band)</b>				
369066B	#16 Small Cut-End Mop	Quick Release/Quick Change	00	12 ea
369070B	#20 Medium Cut-End Mop	Quick Release/Quick Change	00	12 ea
369074B	#24 Large Cut-End Mop	Quick Release/Quick Change	00	12 ea
369082	#32 X-Large Cut-End Mop	Quick Release/Quick Change	00	12 ea
<b>4-Ply Cotton (Kwik-On Screw Top)</b>				
369024C	#24 Kwik-On Cotton Mop	Kwik-On	00	12 ea
<b>4-Ply Rayon (Kwik-On Screw Top)</b>				
369024R	#24 Kwik-On Rayon Mop Head	Kwik-On	00	12 ea
<b>Kwik-On Handle</b>				
40345	60" Kwik-On Handle 1.13" Diameter	—	00	12 ea

# SPONGE MOPS & MOP HANDLES

## Automatic Sponge Mop

- Recommended for mopping smooth surfaces
- Synthetic sponge head absorbs liquid fast

## Ty-Dee™ Sponge Mop

- Recommended for mopping smooth surfaces
- Cellulose sponge head with non-corrosive metal parts and enameled wood handle



## Jaw Style Mop Handles

- Use with wide band mops

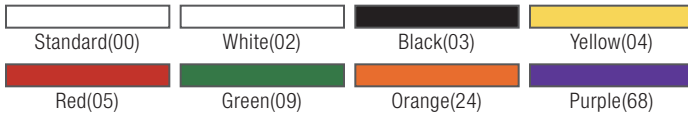
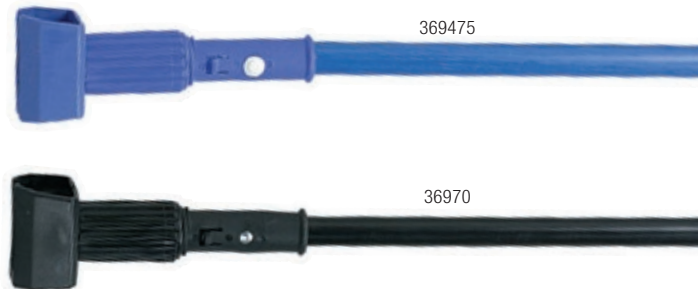

Prod No	Description	Dia	Color	Pack
<b>Automatic Sponge Mops – Aluminum Handle</b>				
40300	8.5" Automatic Sponge Mop	—	00	12 ea
40301	12" Automatic Sponge Mop	—	00	6 ea
40305	8.5" Automatic Sponge Mop Refill	—	00	12 ea
40306	12" Automatic Sponge Mop Refill	—	00	6 ea
<b>Ty-Dee Sponge Mop – Enamel Wood Handle</b>				
36990	9" Ty-Dee Sponge Mop with Built-in Wringer	—	00	12 ea
36990R	9" Ty-Dee Refill	—	00	12 ea
<b>Jaw Style Mop Handles</b>				
369475	60" Fiberglass Mop Handle	1"	00, 02, 03, 04, 05, 09, 24, 68	12 ea
36970	60" Vinyl Coated Metal Mop Handle	.94"	00	12 ea

# MOP HANDLES

## Quick-Release Mop Handles

- 60" durable fiberglass
- Flexible plastic head with hinged gripper bites into any size mop band
- Releases mop head quickly; employees never need to touch a dirty mop head



41664

369595

## Quick Change Handles

- Use with narrow band mops
- Plastic head with thumb wheel clamps mop in place
- Metal heads feature standard wing nut construction with a quick release cross bar



40340



369365



369375



36968

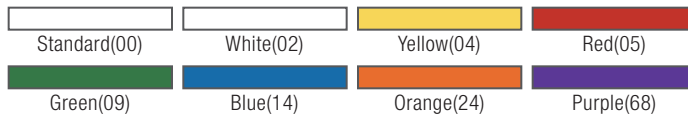

Prod No	Description	Dia	Color	Pack
<b>Color-Coded Quik-Release Mop Handle</b>				
41664	60" Fiberglass Mop Handle	1"	02, 04, 05, 09, 14, 24, 68	12 ea
<b>Quik-Release Handle</b>				
369595	Quik-Release Vinyl-Coated Metal Handle	—	00	12 ea
<b>Quick Change Handles – Wood</b>				
369365	60" Wood Mop Handle with Plastic Head	1.13"	00	12 ea
40340	63" Wood Mop Handle with Metal Head	1.13"	00	12 ea
<b>Quick Change Handle – Fiberglass</b>				
369375	60" Fiberglass Mop Handle with Plastic Head	1"	00	12 ea
<b>Quick Change Handle – Vinyl Coated Metal</b>				
36968	60" Handle with Plastic Head	1"	00	12 ea

# MOP BUCKETS & SIGNS

## Bucket & Wringer Combos

- Made of durable, corrosion resistant polyethylene
- Non-marking casters
- Available in 26 or 35 quart sizes
- Individual Side Press Wringer available – fits both 26 quart (36908) and 35 quart (36904) mop buckets



36904



36908W



36905



36908

## Wet Floor Signs

- Durable polypropylene
- Specially designed feet protect floor finishes
- 36900 locks into place to prevent collapsing
- Compact for easy storage



36909



36900

## Freestanding Caution Cones

- 360° visibility
- Caution message appears in English, Spanish and French



36941



36942

Case for 36942 Pop Up Caution Cone



## Caution Pop Up Cones

- 360° visibility
- Caution message appears in English, Spanish and French
- Case can be mounted to wall for easy access



Prod No	Description	Color	Pack
<b>Mop Buckets</b>			
36908	26 qt Bucket with Side Press Wringer	04, 05, 09, 14, 69	1 ea
36904	35 qt Bucket with Side Press Wringer	04, 05, 09, 14, 69	1 ea
36908W	Side Press Wringer for 26 qt and 35 qt Mop Bucket	04, 05, 09, 14, 69	1 ea
36905	35 qt Bucket with Down Press Wringer	04	1 ea
36908C	3" Swivel Casters for all Mop Buckets	00	2 ea
<b>Folding Wet Floor Signs</b>			
36900	Floor Sign (English/Spanish)	00	6 ea
36909	Economy Wet Floor Sign (English/Spanish/German)	04	6 ea
<b>Caution Cones</b>			
36941	36" Caution Cone	04	3 ea
36942	20" Pop Up Caution Cone	04	12 ea

# FLOOR & RESTROOM MAINTENANCE

## Floor Drain Brush

- Long lasting polypropylene bristles and plastic handles stand up to rugged use
- Drain Brush handles (sold separately) are prominently marked in English and Spanish for "floor drain use only" to prevent contact with food and serving utensils
- Available in a variety of sizes



40146

## Drain Opener

- Convenient, sanitary way to remove floor drain covers
- Easy to use, simply insert into drain and twist to remove drain cover and drain basket
- One-piece construction with plastic handles for secure grip



40144



Standard(00)      White(02)

Prod No	Description	Color	Pack
<b>Drain Opener</b>			
40144	Drain Opener	02	12 ea
<b>Floor Drain Brush</b>			
40146	3" Floor Drain Brush	00	6 ea
40147	4" Floor Drain Brush	00	6 ea
41093	5" Floor Drain Brush	00	6 ea
40148	6" Floor Drain Brush	00	6 ea
40236	36" Plastic Drain Brush Handle	00	12 ea
40237	48" Plastic Drain Brush Handle	00	12 ea

## Boot 'N Shoe Brush

- Helps eliminate dirt and other contaminants from being tracked into food prep and serving areas
- Chromed steel tube frame can be bolted to floor for security; brushes flip up to expose a steel scraper
- Non-absorbent plastic block construction with long lasting blue polypropylene bristles



## Bowl Brushes

- Bowl brushes are available in a variety of styles and bristle materials
- 40140 has 180° bristle head to prevent splash-back
- 36232 and 36233 have all-natural cotton yarn securely attached to smooth wood handle



## Ergonomic Force Cup

- Ergonomic design maximizes applied force while maintaining ease and longevity of use
- Over-molded rubber handle for easy grip
- 21" plastic handle is non-absorbent and more sanitary than wood handles

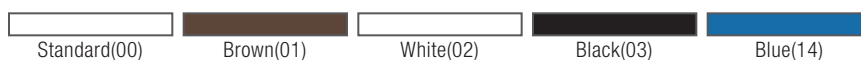

Prod No	Description	Handle Material	Color	Pack
<b>Boot 'N Shoe Brush</b>				
40424	Boot 'N Shoe Brush	—	01, 03, 14	1 ea
40425	Boot 'N Shoe Brush Replacement	—	01, 03, 14	12 ea
<b>Bowl Brushes</b>				
40140	17" No-Splash Polyester Brush	Plastic	00	12 ea
36P5	17" Twist-In-Wire Synthetic Bristle Brush	Plastic	02	24 ea
3633	21" Twist-In-Wire Synthetic Bristle Brush	Plastic	00	24 ea
36232	10" Cotton Bowl Mop	Wood	00	36 ea
36233	20" Cotton Bowl Mop	Wood	00	36 ea
<b>Ergonomic Power Plunger</b>				
36439	Ergonomic Power Plunger	Plastic/Rubber	03	12 ea

# HANDLE GUIDE

Prod No	Page	Description	Type of Handle	Recommended Handle
<b>Duo-Sweep Brooms</b>				
36859	279	7" Duo-Sweep Flagged Broom	Threaded	362019414
36863	279	9" Duo-Sweep Flagged Broom	Threaded	362019414
36883	279	11" Duo-Sweep Flagged Broom	Threaded	362019414
36860	279	7" Duo-Sweep Unflagged Broom	Threaded	362029403
36864	279	9" Duo-Sweep Unflagged Broom	Threaded	362029403
36884	279	11" Duo-Sweep Unflagged Broom	Threaded	362029403
<b>Sweeps</b>				
41880	282	18" Omni Sweep	Threaded	40225
41881	282	24" Omni Sweep	Threaded	40225
36204818	283	18" Foam Block Fine Sweep	Threaded	40225
36204824	283	24" Foam Block Fine Sweep	Threaded	40225
40564	283	18" Foam Block Medium Sweep	Threaded	40225
40565	283	24" Foam Block Medium Sweep	Threaded	40225
40561	283	18" Foam Block Medium Sweep	Threaded	40225
40562	283	24" Foam Block Medium Sweep	Threaded	40225
362208P18	283	18" Foam Block Medium Sweep	Threaded	40225
362208P24	283	24" Foam Block Medium Sweep	Threaded	40225
36207218	284	18" Foam Block Heavy Sweep	Threaded	40225
36207224	284	24" Foam Block Heavy Sweep	Threaded	40225
45222	284	24" Palmyra Heavy-Duty Sweep	Threaded/Tapered	40225
367618	284	18" Heavy-Duty Sweep	Threaded/Tapered	40276
367624	284	24" Heavy-Duty Sweep	Threaded/Tapered	40276
<b>Floor &amp; Deck Scrubs</b>				
36175	287	10" Wood Block Sweep	Tapered	40261
36275	287	12" Wood Block Sweep	Tapered	40261
36193	287	10" Wood Block Scrub	Threaded/Tapered	40225
36192	287	10" Wood Block Sweep	Threaded/Tapered	40225
36292	287	12" Wood Block Scrub	Threaded/Tapered	40225
40423	287	10" Hi-Lo Floor Scrub Brush	Threaded	40225
36197	287	10" Dual Surface Scrub Brush	Threaded	40225
36190	287	10" Dual Action Scrub Brush	Threaded	40225
40422	287	10" Dual Action Scrub Brush	Threaded	40225
365300	288	8" Swivel Scrub	Threaded	40225
365310	288	8" Swivel Scrub	Threaded	40225
40430	288	9" Floor Scrub Brush	Threaded	40225
365320	288	Swivel Head Grout Brush	Threaded	40225
41323	289	9" Tile & Grout Brush	Threaded	40225



Prod No	Page	Description	Type of Handle	Recommended Handle
<b>Floor Squeegees</b>				
40081	289	18" Straight Steel Squeegee	Tapered	40261
40082	289	24" Straight Steel Squeegee	Tapered	40261
40083	289	30" Straight Steel Squeegee	Tapered	40261
366318	290	18" Straight Squeegee	Tapered	40261
366324	290	22" Foam Squeegee	Tapered	40261
366330	290	30" Soft Black Foam Rubber	Tapered	40261
41567	290	18" Plastic Squeegee	Threaded	40225
41568	290	24" Plastic Squeegee	Threaded	40225
366824	290	22" Foam Squeegee Threaded Socket	Threaded	40267
366918	290	18" Red Foam Rubber	Threaded	40225
366922	290	22" Red Foam Rubber	Threaded	40225
367818	291	18" Rubber Squeegee with Bristles	Threaded	40210
36324C	291	24" Curved End Black Rubber Squeegee	Tapered	40261
36336C	291	36" Curved End Black Rubber Squeegee	Tapered	40261
36567	291	20" Solid, One-Piece Rubber Squeegee	Threaded	40225
36568	291	24" Solid, One-Piece Rubber Squeegee	Threaded	40225
40075	292	18" Straight Steel Squeegee	Tapered	40261
40076	292	24" Straight Steel Squeegee	Tapered	40261
40077	292	36" Straight Steel Squeegee	Tapered	40261
<b>Misc Floor Care</b>				
40146	308	3" Floor Drain Brush	Threaded (Female)	40236
40147	308	4" Floor Drain Brush	Threaded (Female)	40237
41093	308	5" Floor Drain Brush	Threaded (Female)	40237
40148	308	6" Floor Drain Brush	Threaded (Female)	40238



**CARLISLE**  
FOODSERVICE PRODUCTS

PROFESSIONAL  
DURABLE  
TOUGH  
HARD-  
WORKING  
**TRANS-  
PORTATION  
EQUIPMENT**

---

*Carlisle's high quality dollies, carts and caddies help you reduce the risk of food contamination and employee injuries.*





# CARTS

Our **unique combination** of space saving design, load capacity and long-lasting durability provide **superior value** and make Fold 'N Go the transport cart every foodservice operation needs.

**Perfect for full kitchens, hallways or off-site catering;** Fold 'N Go Carts **support 350 pounds** and fold up in a single, quick and easy motion. The cart **ships fully assembled** making ownership a joy from the very beginning.

## Fold 'N Go® Carts

- Folds up to store easily behind doors, between counters or in small spaces
- Solid legs and sturdy shelves hold up to 350 pounds
- Cart ships fully assembled; no tools or complicated latches required
- Collapses to 9" width and 10.5" width; stores easily behind doors, in between counters or back of delivery vans
- Folds down, tucks away and is always available for multiple purposes
- Shelves are easy to clean; top shelf has ergonomically shaped, easy grip handles at both ends for a fast, secure grip
- 4" heavy-duty, non-marking swivel casters with molded-in metal reinforcement plates are permanently staked to .75" solid aluminum legs for longer life and added strength and rigidity

Licensed Product under U.S. Patent No. 5806864

SBC1521



SBC2031

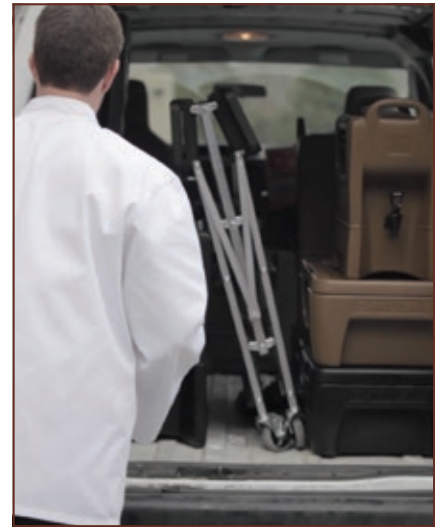

SBC1521



Find replacement parts at  
[www.carlislefsp.com/replacement-parts](http://www.carlislefsp.com/replacement-parts)



350 lb Capacity



Easily folds with one hand



Prod No	Description	Weight Capacity	Color	Pack
<b>Fold 'N Go Carts</b>				
SBC1521	15" x 21" Fold 'N Go Cart	350 lb	03, 23	1 ea
SBC2031	20" x 31" Fold 'N Go Cart	350 lb	03, 23	1 ea
SBCC240	Fold 'N Go Cart Replacement Caster, Swivel	—	00	1 ea
SBCC245	Fold 'N Go Cart Replacement Caster, Swivel with Brake	—	00	1 ea
SBCA30000	Fold 'N Go Cart Replacement Slide Bracket Assembly	—	—	1 ea
SBCRKIT	Fold 'N Go Hardware Replacement Kit (includes 2 casters)	—	—	1 ea



# CARTS

## Bussing Carts

- Durable construction stands up to the toughest use
- Molded on handles that will not come apart when rolling over bumps and uneven surfaces
- Raised edges on shelves for quick loading and protect from spills and accidents
- Available with optional back panels to hide clutter or locking doors to secure sensitive items like liquor or cleaning supplies (15" x 21" size only)



Find replacement parts at [www.carlislefsp.com/replacement-parts](http://www.carlislefsp.com/replacement-parts)



CC2036DP, available with locking doors and side panels to secure sensitive items



Prod No	Description	Weight Capacity	Color	Pack
<b>Bussing Carts</b>				
CC2243 $\Delta$	42" x 23" Large Bussing Cart	300 lb	03	1 ea
CC2036 $\Delta$	18" x 36" Bussing Cart	300 lb	03	1 ea
CC2036DP	18" x 36" Bussing Cart with Doors and Back Panels	300 lb	03	1 ea
CC2036P	18" x 36" Bussing Cart with Back Panels	300 lb	03	1 set
CD2036	18" x 36" Doors and Back Panels Only	—	03	1 set
CP2036	18" x 36" Back Panels Only	—	03	1 set
CC11SH $\blacklozenge$	Accessory Bin for Bussing Cart	—	03	1 ea
CC11TH	Trash Bin for Bussing Cart	—	03	1 ea

NSF Listed products are designated with a  $\Delta$  and may be prefixed with an N

Shipping Notes: CC2036 & SBC1521 can ship UPS/FedEx Ground at oversize cost, CC2243 & SBC2031 cannot ship UPS/FedEx Ground

$\blacklozenge$  California Residents: Bisphenol A **WARNING:** See appendix A on page 281



## Stainless Steel Utility Carts

- Utility carts are constructed of heavy gauge stainless steel for superior strength and durability
- Continuous weld construction provides added durability as compared to other, spot welded utility carts
- Non-marking soft rubber bumpers prevent scratches and scuffs on walls



UC4031529



UC3031524



UC7022133

## Service Cart

- One-piece design, all plastic construction
- Polyethylene exterior and polyurethane foam core for added strength
- Heavy-duty 5" non-marking caster with molded-in metal reinforcement plates
- Optional Trash Container (SBC11TC) and Part Holder (SBC11SH) available separately
- NSF Listed



Find replacement parts at [www.carlislefsp.com/replacement-parts](http://www.carlislefsp.com/replacement-parts)



SBC230 with SBC11TC and SBC11SH

Black(03)

Prod No	Description	Weight Capacity	Color	Pack
<b>Service Cart</b>				
SBC230 $\Delta$	Service Cart - 2 Fixed Casters, 2 Swivel Casters, 1 with Brake	500 lb	03	1 ea
SBC11SH	Part Holder for SBC230	—	03	1 ea
SBC11TC	Trash Container for SBC230	—	03	1 ea
<b>Stainless Steel Utility Carts</b>				
UC3031524	15.5" x 24", 3 Shelf Utility Cart	300 lb	—	1 ea
UC3031827	18" x 27", 3 Shelf Utility Cart	300 lb	—	1 ea
UC5031524	15.5" x 24", 3 Shelf Utility Cart	500 lb	—	1 ea
UC5031827	18" x 27", 3 Shelf Utility Cart	500 lb	—	1 ea
UC5032135	21" x 35", 3 Shelf Utility Cart	500 lb	—	1 ea
UC7022133	21" x 33", 2 Shelf Utility Cart	700 lb	—	1 ea
UC7032133	21" x 33", 3 Shelf Utility Cart	700 lb	—	1 ea
UC4031529	15.75" x 29.5", 3 Shelf Knock-Down Utility Cart	400 lb	—	1 ea
UC4031733	17.75" x 33.38", 3 Shelf Knock-Down Utility Cart	400 lb	—	1 ea

NSF Listed products are designated with a  $\Delta$  and may be prefixed with an N

Shipping Notes: SBC230, UC3031524, UC3031827, UC5031524, UC5031827, UC5032135, UC7031524, UC7031827, UC7022133, UC7032133 cannot ship UPS/FedEx



# CARTS

## Utility Carts

- Excellent for transporting equipment and heavy loads
- Bin top utility carts (UC4018 & UC4525) reduce the potential for items to fall off during transport
- Durable and chemical-resistant polypropylene construction; will not rust, dent, chip or peel
- Convenient knock-down design
- Integrated cord wrap for easy access (UC1940)



UC1940



UC4018



UC1940

Find replacement parts at [www.carlislefsp.com/replacement-parts](http://www.carlislefsp.com/replacement-parts)



Prod No	Description	Weight Capacity	Color	Pack
<b>Utility Carts</b>				
UC1940	19" x 40" x 32.5" Utility Cart	500 lb	23	1 ea
UC4018	40" x 17.25" Small Bin Top Utility Cart	500 lb	23	1 ea
UC4525	45" x 25" Large Bin Top Utility Cart	500 lb	23	1 ea
UCC4018	Replacement Casters for UC4018 & UC4525 (Swivel, 2 pack)	—	00	1 cs
UCC4525	Replacement Casters for UC4018 & UC4525 (Fixed, 2 pack)	—	00	1 cs



# DISH DOLLIES

## Optimizer™ Adjustable Dish Dollies

- Adjustable dividers eliminate the need for individually sized dollies
- Dollies hold plates from 5.5" to 12.5"
- Polyethylene dividers and walls help prevent dish edge chipping
- Two-handed access to all plates reduces breakage
- Non-marking casters (2 locking, 2 non-locking) for easy transport of loaded dollies
- Includes vinyl cover with easy-opening hook & loop side included for sanitary storage
- Find replacement parts at [www.carlislefsp.com/replacement-parts](http://www.carlislefsp.com/replacement-parts)
- NSF Listed



### ADD4, ADD6 Optimizer Dollies Also Feature:

- Most flexible dolly available; holds trays, plates, and platters
- ADD6 holds oval platters from 9.5" x 7.25" to 13.5" x 10.5"
- Holds 5 stacks of 9.88" to 11.25" plates; 25% more than any other similar dish dolly
- Holds 8 stacks of 5.5" to 8.25" plates; 33-50% more than any other similar dish dolly (up to 50 or more plates per stack, depending on plate profile)
- Use 2 to 4 dividers for 10" or larger plates; 6 dividers for 8" to 9.75" plates; 8 dividers for 8 stacks of 7.75" or smaller plates
- 2 dividers for 13.5" x 10.5" platters; 6 dividers for 9.5" x 7.25" to 12" x 9.25" platters.

### ADS4, ADS8 Optimizer Dollies Also Feature:

- Smaller size fits through narrow corridors or under tables
- Flexible configuration holds a variety of plates and platters



ADD4



ADD6

ADD6 Vinyl Cover with ADD6



Prod No	Description	Color	Pack
<b>Optimizer Standard Dish Dollies &amp; Accessories</b>			
ADD4 $\Delta$	Optimizer Dish Dolly with 4 Dividers	01*, 03	1 ea
ADD6 $\Delta$	Optimizer Dish Dolly with 6 Dividers	01*, 03	1 ea
ADDD $\Delta$	Optimizer Replacement Dividers (Set of 2)	01, 03	2 ea
ADDC $\diamond$	Optimizer Vinyl Replacement Cover (for ADD4 or ADD6)	07	1 ea
<b>Optimizer Small Dish Dollies &amp; Accessories</b>			
ADS4 $\Delta$	Optimizer Small Dish Dolly and 4 Adjustable Dividers	03	1 ea
ADS8 $\Delta$	Optimizer Small Dish Dolly and 8 Adjustable Dividers	03	1 ea
ADSD	Optimizer Replacement Dividers (Set of 4)	03	1 ea
ADSC $\diamond$	Optimizer Vinyl Replacement Cover (for ADS4 or ADS8)	07	1 ea

NSF Listed products are designated with a  $\Delta$  and may be prefixed with an N

Note: ADD4, ADD6, ADS4, ADS8 cannot ship UPS/FedEx

\*Color available by special order only

$\diamond$  California Residents: Di(2-ethylhexylphthalate) (DEHP) **WARNING:** See appendix B on page 1



# Optimizer Adjustable Dish Dolly Guide

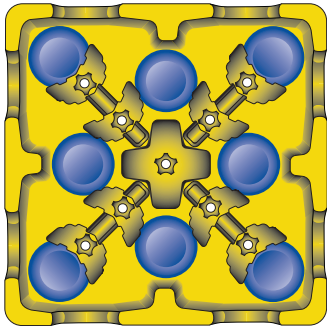

ADS8 Layout for 5.5" round plates

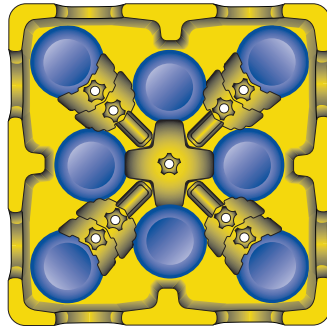

ADS8 Layout for 6.5" round plates

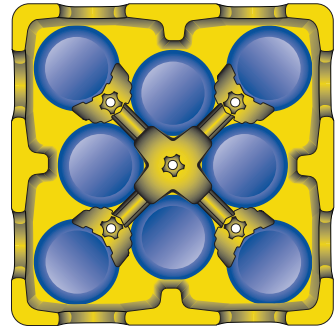

ADS4 Layout for 7.5" round plates and 6" square plates

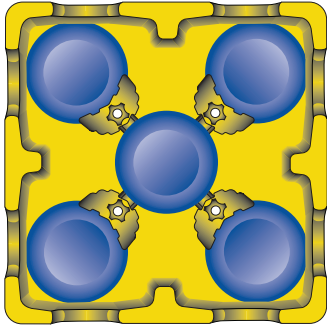

ADS4 Layout for 9" round plates

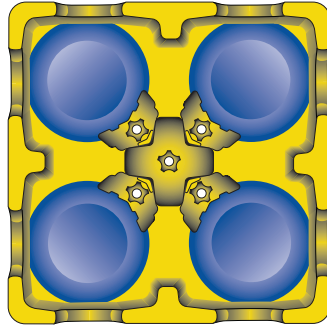

ADS4 Layout for 11" round plates and 8.5" square plates

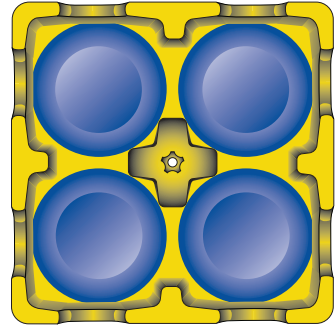

ADS4 Layout for 12" round plates

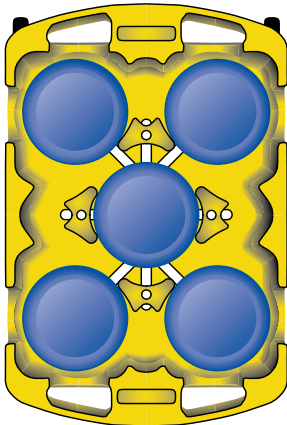

ADD4 Layout for 9.88" to 11.25" round plates

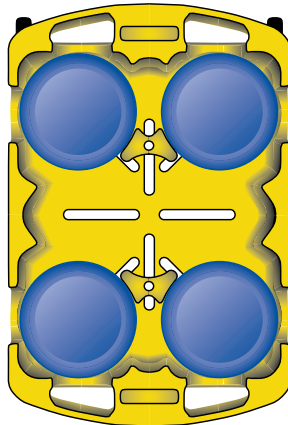

ADD4 Layout for 11.38" to 12.5" round plates, 8.5" to 10.5" square plates and 13.5" by 10.5" platters

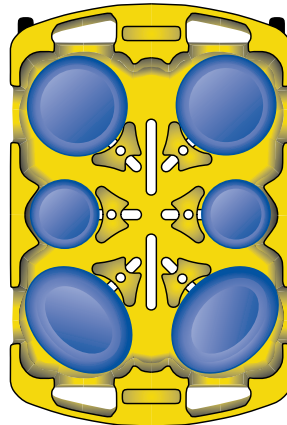

ADD6 Layout for 12" by 9" to 9.5" by 7.25" platters, 5.5" to 8" and 5.5" to 12" round plates

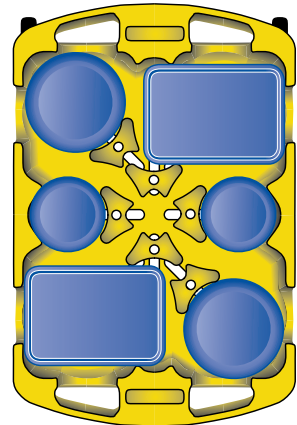

ADD6 Layout for 10" by 14.5" trays and 7.5" and 10" round plates

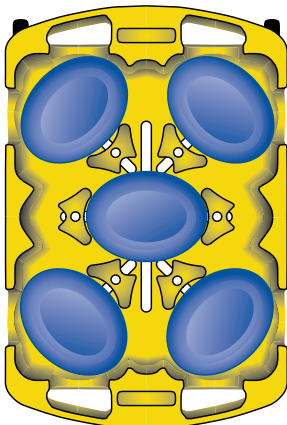

ADD6 Layout for 12" by 9.25" to 9.5" by 7.25" platters

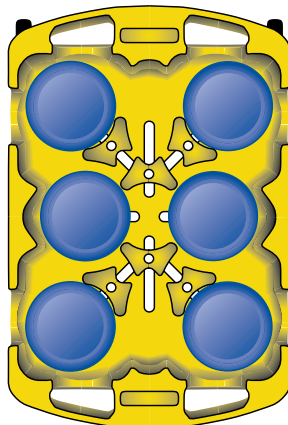

ADD6 Layout for 8.38" to 9.75" round plates

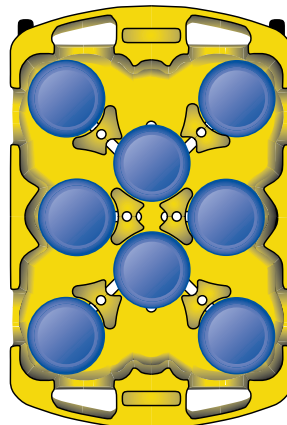

ADD6 Layout for 8" to 8.25" round plates

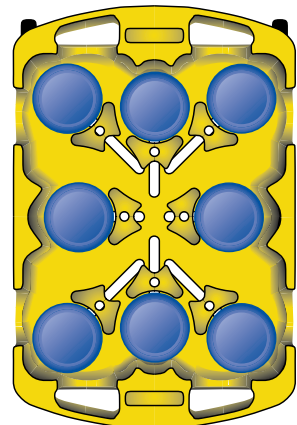

ADD6 Layout with 2 Additional Dividers for 5.5" to 7.88" round plates

# JANITORIAL CARTS

## Janitorial Carts & Accessories

- Rugged polypropylene resists cracking, peeling and corrosion
- Three durable shelves with raised edges keep items organized
- Platform base holds a Bucket/Wringer or 23 gallon TrimLine™ Waste Container
- Includes a 25 gallon nylon bag for waste or laundry collection
- 3" standard Carlisle non-marking swivel casters in front; large 8" non-marking rear wheels

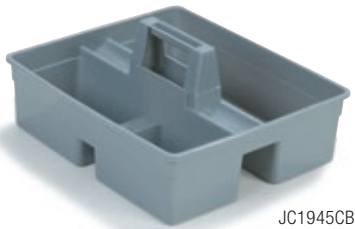

Integrated tool holders, shelves and hooks keep everything organized including unwieldy handles.



Front hooks hold most standard Wet Floor Signs. Built-in hanger holds multiple spray bottles.



Structurally reinforced base and heavy-duty casters/wheels withstand rough use – holds up to 300 lbs.



Tough 25 gallon nylon bag easily attaches to cart arm. Hooks on top of arm to hold trash liners in place. Arm swings up for more compact storage when not in use.

### Tool Caddy

- Handled caddy fits in the top compartment of the JC1945 cart series
- Deep compartments prevent spills
- Made of durable polypropylene

Prod No	Description	Weight Capacity	Color	Pack
<b>Janitorial Carts &amp; Accessories</b>				
JC1945S	45"L x 19"W x 39"H Short Platform Janitorial Cart	300 lb	23	1 ea
JC1945L	49"L x 19"W x 39"H Long Platform Janitorial Cart	300 lb	23	1 ea
JC1946	Replacement Bag for JC1945S & JC1945L	—	14	1 ea
JC1945CB	Tool Caddy for Janitorial Cart	—	23	1 ea
36908C	3" Replacement Casters	—	00	2 ea



**CARLISLE**  
FOODSERVICE PRODUCTS



RUGGED  
QUALITY  
DURABLE  
**WASTE  
MANAGEMENT  
PRODUCTS**

---

*Carlisle offers a solution for all of your waste and material handling needs. Our products are built to last and feature the rugged construction and durability you expect.*



# WASTE CONTAINERS & LIDS

When it comes to **waste and material handling**, you can count on Carlisle to deliver products designed for **heavy duty usage**.

## Bronco™

- Heavy-duty construction with double-reinforced stress ribs; drag skids for durability
- Comfort Curve™ handles provide easy handling
- Helper handles on base for controlled tipping or overhead lifting
- Reinforced lids have snap down tab locks with a simple press & pull release system for easy removal
- NSF Std 21 – meets the criteria for thermoplastic refuse containers
- NSF Std 2 – meets the criteria for food contact and cleanability

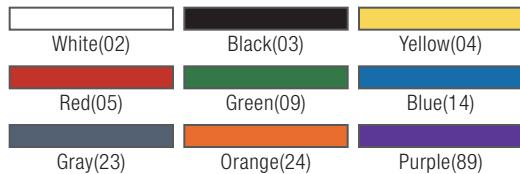

### Built-In Durability

Prod No	Description	Color	Pack
<b>Bronco Round Waste Containers &amp; Lids</b>			
341010 Δ	10 gal Waste Container, 16.13" x 17"	02, 03, 04, 05, 09, 14, 23, 24, 89*	6 ea
341011 Δ	10 gal Lid, 16.13" x 2"	02, 03, 04, 05, 09, 14, 23, 24, 89	6 ea
341020 Δ	20 gal Waste Container, 20" x 23"	02, 03, 04, 05, 09, 14, 23, 24, 89*	6 ea
341021 Δ	20 gal Lid, 20" x 2.13"	02, 03, 04, 05, 09, 14, 23, 24, 89*	6 ea
341032 Δ	32 gal Waste Container, 22.38" x 27.75"	02, 03, 04, 05, 09, 14, 23, 24, 89	4 ea
341033 Δ	32 gal Lid, 24" x 2.13"	02, 03, 04, 05, 09, 14, 23, 24, 89	4 ea
341034	32 gal Dome Lid	03	1 ea
341035	32 gal Funnel Lid	03	4 ea
341044 Δ	44 gal Waste Container, 26.88" x 31.38"	02, 03, 04, 05, 09, 14, 23, 24, 89	3 ea
341045 Δ	44 gal Lid 26.88" x 2.25"	02, 03, 04, 05, 09, 14, 23, 24, 89	3 ea
341055 Δ	55 gal Waste Container, 26.5" x 33"	02, 03, 04, 05, 09, 14, 23, 89*	2 ea
341056 Δ	55 gal Lid, 26.5" x 2.25"	02, 03, 04, 05, 09, 14, 23, 89*	2 ea
341057	44/55 gal Dome Lid	03	1 ea
341132 Δ	32 gal Container with Dolly, 22.38" x 38.25"	02, 04, 05, 09, 14, 23	4 ea
341144 Δ	44 gal Container with Dolly, 26.88" x 37.75"	02, 04, 05, 09, 14, 23	3 ea

NSF Listed products are designated with a Δ and may be prefixed with an N

\*Color available by special order only

### 9 Colors

Our round Bronco containers come in 9 colors and are made with NSF 2 certified materials which meet the criteria for food contact and cleanability. Excellent for storing and segregating large amounts of food products.



### Hot Stamped Bronco™ Containers

- Carlisle offers several standard Hot Stamped containers for waste management, visit [carlislefsp.com/custom-imprinting](http://carlislefsp.com/custom-imprinting)
- Standard stamps:
  - INEDIBLE
  - USDA CONDEMNED
  - TRASH
  - ICE ONLY
  - ICE MELT
- Custom hot stamping is also available; contact Customer Service at 1-800-654-8210 for custom imprinting information



### Tool Caddy Bag

- Economical, adjustable caddy bag can hold an assortment of cleaning tools
- Turns a 32 or 44 gallon Bronco into a portable and durable cleaning system platform



Prod No	Description	Color	Pack
<b>Hot Stamped Bronco Container</b>			
341010ICE Δ	10 gal "Ice Only" Container	02	6 ea
<b>Tool Caddy Bag</b>			
36917	Tool Caddy Bag for 32 & 44 gal Bronco Waste Containers	04	12 ea

NSF Listed products are designated with a Δ and may be prefixed with an N

# WASTE CONTAINERS & LIDS

## Carlisle Dollies

- Dollies fit our 20, 32, 44 and 55 gallon containers for safe transport of heavy loads
- Simple twist-to-lock feature securely attaches dolly to containers
- Dollies include standard Carlisle non-marking 3" swivel casters
- NSF Std 2—meets the criteria for food contact and cleanability

36910



## 50 Gallon Roll-Away Container

- Super heavy-duty axle and oversize traction wheels make hauling heavy loads easy
- Unique handle design gives positive grip even when wet
- Sturdy hinged lid flips open 270° and snaps shut tight
- NSF Std 21 – meets the criteria for thermoplastic refuse containers
- NSF Std 2 – meets the criteria for food contact and cleanability

345050



Recycling options shown on pages 330-331



Prod No	Description	Color	Pack
<b>Carlisle Dollies</b>			
36911 Δ	Standard Round Container Dolly, 17.75" x 6"	03	2 ea
36910 Δ	Round Container Dolly with Replaceable Casters	03	2 ea
3672231	3" Replacement Caster for 36910 Dolly	—	1 ea
<b>Roll-Away Container</b>			
345050 Δ	50 gal Rolling Container, 21" x 21" x 38.25"	14, 23	2 ea

NSF Listed products are designated with a Δ and may be prefixed with an N



## TrimLine™

- Designed for narrow spaces
- Self-venting for easier bag removal
- Corner tabs keep bag in place
- Helper handle on bottom makes lifting and dumping easier



342023  
369210



369210

## TrimLine™ Dolly

- Efficient transport reduces transportation time
- Low profile design allows dolly and container to fit under standard foodservice counters
- For use with 15 or 23 gallon size TrimLine container or similar competitor slim-style trash cans
- 200 lb weight capacity



Prod No	Description	Color	Pack
<b>TrimLine Containers</b>			
342015	15 gal TrimLine Container	23	4 ea
342023	23 gal TrimLine Container	03, 06, 09, 14, 23, 69	4 ea
342024	TrimLine Swing Top Lid, 20.13" x 11.5" x 4.5"	03, 06, 23, 69	4 ea
342025	TrimLine Handled Lid, 20.5" x 11.5" x 3"	03	4 ea
369210	TrimLine Dolly	03	1 ea

# WASTE CONTAINERS & LIDS

## Centurian™

- Attractive yet durable
- Self-venting design for easier bag removal
- Corner tabs keep bag in place



 Recycling options shown on pages 330-331



Prod No	Description	Color	Pack
<b>Centurian Waste Containers</b>			
343021	21 gal Half Round Centurian Container	06, 23	4 ea
343022	Half Round Centurian Lid for 343021	03, 06, 23	4 ea
343122	22 gal Tall Round Centurian Container	23	4 ea
343123	Swing Top Centurian Lid for 343122	23	4 ea
343124	Funnel Top Centurian Lid for 343122	23	4 ea
343523	23 gal Tall Square Centurian Container	06, 23, 69	4 ea
343525	Swing Top Centurian Lid for 343523	03, 06, 23, 69	4 ea
343935	35 gal Centurian Square Waste Receptacle	06, 23	4 ea
343951	Large Centurian Lid for 343935, 343950	06, 23	4 ea

## Office Wastebaskets

- Economical polypropylene
- Smooth inner surface makes cleaning easy
- Light yet durable design



## Fire Resistant Wastebaskets

- Ideal for use in areas or applications requiring an extra degree of fire protection including schools, health care and hospitality
- Textured finish minimizes appearance of scuffs and scratches
- UL Listed; will contain burning paper without contributing fuel to the fire



Prod No	Description	Color	Pack
<b>Office Wastebaskets</b>			
342913	13 qt Office Wastebasket	03, 06, 23	12 ea
342928	28 qt Office Wastebasket	03, 06, 23	12 ea
342941	41 qt Office Wastebasket	03, 06, 23	12 ea
<b>Fire Resistant Wastebaskets</b>			
342915	14 qt Fire Resistant Wastebasket	03	6 ea
342927	28 qt Fire Resistant Wastebasket	03	6 ea
342940	41 qt Fire Resistant Wastebasket	03	4 ea

# RECYCLE CONTAINERS & ACCESSORIES

Recycle options are great for offices, hospitality, industrial, restaurants and more.

## Bronco™



341032REC



341032REC

341033REC

## Centurian™



343527REC

343523REC



343937REC

343935REC



343022

343021REC



Prod No	Description	Color	Pack
<b>Bronco Recycle Waste Containers &amp; Lids</b>			
341020REC Δ	20 gal Recycle Waste Container	09, 14	6 ea
341021REC Δ	20 gal Recycle Lid with 8" Hole	09, 14	6 ea
341032REC Δ	32 gal Recycle Waste Container	09, 14	4 ea
341033REC Δ	32 gal Recycle Lid with 8" Hole	09, 14	4 ea
341044REC Δ	44 gal Recycle Waste Container	09, 14	3 ea
341045REC Δ	44 gal Recycle Lid with 8" Hole	14	3 ea
<b>Centurian Recycle Waste Containers &amp; Lids</b>			
343021REC	21 gal Half Round Centurian Recycle Container	14	4 ea
343022	Half Round Centurian Lid for 343021REC	03	4 ea
343523REC	23 gal Tall Square Centurian Recycle Container	14	4 ea
343526REC	Paper Recycle Centurian Lid for 343523REC	14	4 ea
343527REC	Bottle/Can Recycle Centurian Lid for 343523REC	14	4 ea
343935REC	35 gal Recycle Centurian Square Waste Receptacle	14	4 ea
343936REC	Bottle/Can Recycle Centurian Lid for 343935REC, 343950REC	14	4 ea
343937REC	Paper Recycle Centurian Lid for 343935REC, 343950REC	14	4 ea
34RECLBL	Recycle Label Kit	—	1 ea

NSF Listed products are designated with a Δ and may be prefixed with an N

TrimLine™



Recycle Label Kit



34RECLBL

Includes one set of eleven color-coded symbol labels and three sets of eleven word labels in English, Spanish and French

Roll-Away



Office Wastebaskets



Prod No	Description	Color	Pack
<b>TrimLine Recycle &amp; Compost Containers &amp; Lids</b>			
342015REC	15 gal TrimLine Recycle Container	14	4 ea
342023REC	23 gal TrimLine Recycle Container	09, 14	4 ea
342023CMP	23 gal TrimLine Compost Container	09	4 ea
342026REC	Paper Recycle Lid for 343023REC & 342015REC	14	4 ea
342027REC	Bottle/Can Recycle Lid for 343023REC & 342015REC	14	4 ea
342025	TrimLine Handled Lid	03	4 ea
<b>Carlisle Roll-Away Recycle Container</b>			
345050REC Δ	50 gal Recycle Rolling Container	14	2 ea
<b>Office Recycle Wastebaskets</b>			
342913REC	13 qt Office Recycle Wastebasket	14	12 ea
342928REC	28 qt Office Recycle Wastebasket	14	12 ea
342941REC	41 qt Office Recycle Wastebasket	14	12 ea
<b>Recycle Label Kit</b>			
34RECLBL	Recycle Label Kit	—	1 ea

NSF Listed products are designated with a Δ and may be prefixed with an N

# TILT TRUCKS

Perfect for **transporting bulky loads** and/or consolidating smaller loads for more **efficient transport**

- Lightweight, durable, rotationally molded design improves maneuverability
- Smooth inner and outer surface makes cleaning easy
- Non-marking, swivel casters allow for easy transportation
- 5/8 Yard easily fits through standard doorways
- Made with more than 70% post consumer recycled material
- Meets EPA recommended recovered materials content levels for office recycling containers and waste receptacles and is perfect for specifying on school and government agency bids
- Lids available for each size
- Powder coated steel wheel frame



TTS150

### 5/8 Yard Capacity

Light Duty – 450lb  
 Standard Duty – 850lb  
 Wheel Diameter: 10"  
 Dimensions: 26"W x 38"H x 54"L  
 (fits through standard doorway)



### 1 Yard Capacity

Standard Duty – 850lb  
 Heavy Duty – 1,200lb  
 Wheel Diameter: 10"  
 Dimensions: 32.5"W x 42.75"H x 68"L



### 1.5 Yard Capacity

Heavy Duty – 1,200lb  
 Wheel Diameter: 12"  
 Dimensions: 40.5"W x 48.5"H x 79.5"L



Black(03)

Prod No	Description	Weight Capacity	Color	Pack
<b>Tilt Trucks</b>				
TTL580	5/8 Yard Light Duty	450lb	03	1 ea
TTS580	5/8 Yard Standard Duty	850lb	03	1 ea
TTL580	5/8 Yard Tilt Truck Lid	—	03	1 ea
TTS100	1 Yard Standard Duty	850lb	03	1 ea
TTH100	1 Yard Heavy Duty	1200lb	03	1 ea
TTL100	1 Yard Tilt Truck Lid	—	03	1 ea
TTS150	1.5 Yard Standard Duty	1200lb	03	1 ea
TTL150	1.5 Yard Tilt Truck Lid	—	03	1 ea



# REPLACEMENT PARTS

In order to better identify and find the replacement parts you are looking for, we have created an easy-to-use web page. Please use the web address below and the steps outlined to navigate and find what you are looking for.

[www.carlislefsp.com/replacement-parts](http://www.carlislefsp.com/replacement-parts)

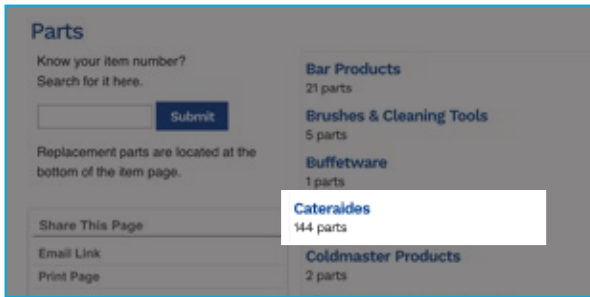
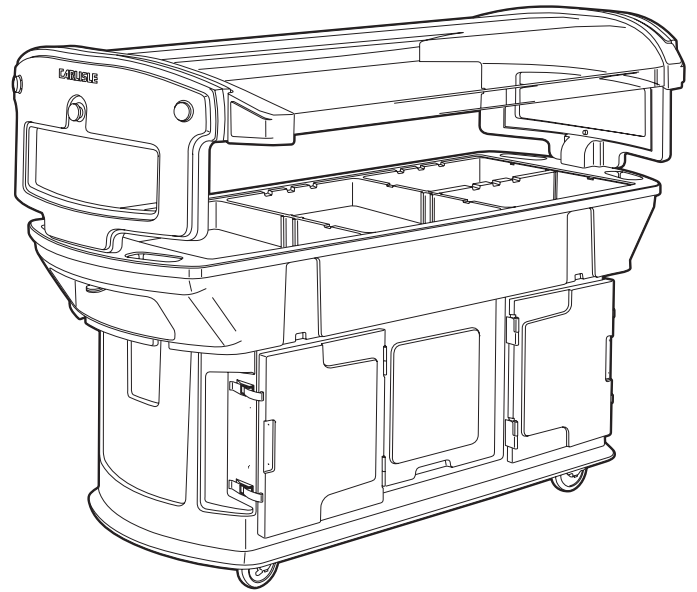

## 2. Replacement Parts Landing Page

You will navigate to a list of product groups with the total amount of parts available listed below the title

**Click on the category you need or search by item #**

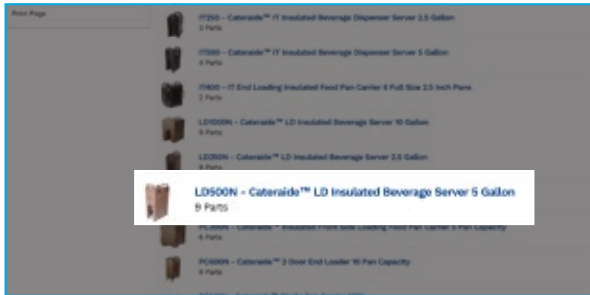

## 3. Category Listing

After choosing your category, you will find a list of products within that category

**Click on the item that needs a new part**

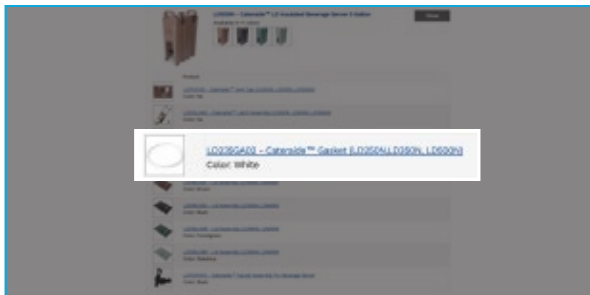

## 4. Available Replacement Parts Drop Down Menu

A drop down menu will reveal the available replacement parts for your product

**Click on the specific replacement part that you need**



## 5. Replacement Part Item Page

Lastly, you will be taken to an item level web page that will list additional information for the part



# CUSTOM DECORATING



Carlisle offers a variety of options to customize the products that we produce. From screen printing to hot stamping, we can add your logo to items ranging from plates to trash cans.



# PRODUCT INDEX

Prod No	Page No	Prod No	Page No	Prod No	Page No	Prod No	Page No
0120	42	10203B	220	10435	222	10720-307	229
0132	42	10210U	220	10436U	222	10721	228
0200	232	10211U	220	10437U	222	10721-307	229
0202	118-119, 232	10212B	222	10438Z	222	10722	228
0203	232	10212B	220	10439Z	222	10722-207	229
0205	232	10215	220	10440B	222	10723	228
0240	121	10216U	220	10440Z	222	10723-207	229
0261	121	10217U	220	10441B	222	10724	228
0287	121	10220B	220	10450U	222	10725	228
0295	121	10221B	220	10463KF	223	10726	228
0296	121	10222B	220	10470U	222	10730	228
0300	118	10223B	220	10471U	222	10730-302	229
0301	118	10230U	220	10476U	222	10731	228
0302	118	10231U	220	10477U	222	10731-302	229
0304	118	10232B	222	10478Z	222	10732	228
0311	118	10232B	220	10479Z	222	10732-202	229
0316	118	10235	220	10480Z	222	10733	228
0333	63	10236U	220	10490U	222	10733-202	229
0340	96	10238Z	220	10491U	222	10734	228
0341	118	10239Z	220	10496U	222	10735	228
0342	118	10240B	220	10510U	222	10736	228
0343	118	10240Z	220	10511U	222	10740	228
0344	96	10241B	220	10516U	222	10741	228
0345	29	10250U	220	10518Z	222	10742	228
0347	29	10256U	220	10519Z	222	10761	231
0350	232	10270U	221	10535	222	10763	231
0355	232	10271U	221	10536U	222	10764	231
0362	59	10276U	221	10537U	222	10765	231
0365	119	10277U	221	10538Z	222	10766	231
0372	119	10278Z	221	10539Z	222	10767	231
0386	253	10279Z	221	10601	143	10768	231
0411	90	10280Z	221	10602	143	10769	231
0470	64	10290U	221	10610	226	10770	231
0475	64	10291U	221	10611	226	10771	231
0600	232	10296U	221	10611C	226	10772	231
0602	118, 232	10297U	221	10612	226	10773	231
0603	232	1030	161	10612C	226	10806	128
0605	232	10302FMT	156	10617	226	10807	128
0700	65	1030FMT	156	10617C	226	10820	133
0703	65	1031	161	10620	226	10828	131
0707	65	10310U	221	10621	226	10850	132
0710	65	10311U	221	10621C	226	10851	132
0713	65	10316U	221	10622	226	10852	132
0717	65	10317U	221	10622C	226	10853	132
0800	232	10318Z	221	10623	226	10854	132
0805	232	10319Z	221	10623C	226	10856	132
0820	59	10335	221	10624	226	10857	132
0830	59	10336U	221	10624C	226	1100GL	163
0831	59	10337U	221	10627	226	1100GR2	162
0843	59	10338Z	221	10627C	226	11020	104
0844	59	10339Z	221	10628	226	11026	104
0845	59	10400B	222	10629	226	11030	104
0852	58	10401B	222	10630	227	11036	104
0855	57	10402B	222	10631	227	1104	42
0860	56	10410U	222	10632	227	1105	42
0862	56	10411U	222	10637	227	1108	42
0864	57	10415	222	10640	227	1110	42
0873	58	10416U	222	10641	227	1110L	53
0875	58	10417U	222	10642	227	1112	42
0878	58	10420B	222	10643	227	1116	42
1000B	87	10421B	222	10644	227	1200	232
10145	160	10422B	222	10647	227	1202	232
10200B	220	10423B	222	10648	227	1205	232
10201B	220	10430U	222	1071	253	1212FG	151-153
10202B	220	10431U	222	10720	228	1212WFG	151

# PRODUCT INDEX

Prod No	Page No	Prod No	Page No	Prod No	Page No	Prod No	Page No
1216LDFG	151, 155	2015DFG	151, 155	30695	221	34101OICE	199, 325
1216LFG	151-154	2015FVG	151-155	30860	222	341011	199, 324
1216LWFG	151, 155	2015GR2	162	30860H	223	341020	324
1217BT	157	2015WFG	151, 155	30860HH	223	341020REC	330
1218FMT	156	2115DFG	151	30861	222	341021	324
1219LDFG	151	2115FVG	151-152	30861H	223	341021REC	330
1219LFG	151-152, 154	2115WFG	151	30861HH	223	341032	324
1219LWFG	151	2200	232	30862	222	341032REC	330
1220DFG	151	2205	232	30869	222	341033	324
1220FVG	151-155	2209	133	30870	222	341033REC	330
1220WFG	151	2210	133	30871	223	341034	324
1220WFG	155	2214DFG	151	30880	222	341035	324
1222LDFG	151	2214FVG	151-155	30881	222	341044	324
1222LFG	151-152, 154	2214WFG	151	30882	222	341044REC	330
1222LWFG	151	2216FVG	151	30883	222	341045	324
1230FMT	156	2216FVGQ	151-155	30884	222	341045REC	330
1252	232	2216GR2Q	162	30885	222	341055	324
1300	66	2216WFGQ	151	30886	222	341056	324
1318DFG	151	2219	133	30887	222	341057	324
1318FVG	151-153, 155	2227	133	30888	222	341132	324
1318FMT	156	2229	133	30895	222	341144	324
1319BT	157	2230	133	30896	222	342015	327
1400GL	163	2310DFG	151	3100GR2	162	342015REC	331
1400GR2	162	2310FVG	151	3210	143	342023	327
1401	161	2310WFG	151	3211	143	342023CMP	331
1410DFG	151, 155	2419	163	3253GR2	162	342023REC	331
1410FVG	151-155	2500	59	33000	16	342024	327
1410WFG	151, 155	2500GR2	162	33002	16	342025	327, 331
1418LDFG	151	2512	99	33004	16	342026REC	331
1418LFG	151-154	2618DFGQ	151	33006	16	342027REC	331
1419DFG	151	2618FVGQ	151-155	33008	16	342913	329
1419FVG	151, 154	2618FMTQ	156	33010	16	342913REC	331
1419WFG	151	2618WFGQ	151	33012	16	342915	329
1520LDFG	151	269DFG	151	33016	16	342927	329
1520LFG	151-155	269FVG	151-155	33018	16	342928	329
1520LWFG	151, 155	269FMT	156	33020	16	342928REC	331
1532	230	269WFG	151, 155	33024	16	342940	329
1544	230	2700GR2	162	33030	17	342941	329
1556	230	2710	233	33032	17	342941REC	331
1568	230	2823	163	33034	17	343021	328
1600GL	163	3004	99	33036	17	343021REC	330
1600GR2	162	3014	163	33038	17	343022	328, 330
1612DFG	151	3016	163	33040	17	343122	328
1612FVG	151-155	3020	161	33042	17	343123	328
1612WFG	151	3022	161	33080	17	343124	328
1629	230	3042	138-139	33082	17	343523	328
1713DFG	151, 155	30580	221-222	33086	17	343523REC	330
1713FVG	151-155	30581	221-222	3316	60	343525	328
1713WFG	151, 155	30582	221-222	3319	60	343526REC	330
1800	232	30583	221-222	33302	82	343527REC	330
1805	232	30660	221	33310	82	343935	328
1814DFG	151, 155	30661	221	33312	82	343935REC	330
1814FVG	151-155	30662	221	33314	82	343936REC	330
1814GR2	162	30669	221	33316	82	343937REC	330
1814WFG	151, 155	30670	221	33318	82	343951	328
1826GR2Q	162	30680	221	33320	82	345050	326
1900	32	30681	221	33322	82	345050REC	331
1960	32	30682	221	33324	82	356	62
1965	32	30683	221	33326	82	36P5	309
1987	32	30684	221	33360	81	361410	286
1989	32	30685	221	33362	81	36141003-1	286
1991	32	30686	221	33364	81	361412	285
1992	32	30687	221	339	96	361415	285
1993	32	30688	221	34RECLBL	330-331	361416	285
1994	32	30689	221	341010	324	361420	286

# PRODUCT INDEX

Prod No	Page No	Prod No	Page No	Prod No	Page No	Prod No	Page No
361437	286	365320	289, 310	36942	307	38704CSIB	141
36175	287, 310	365351	289	369420	302	38705C	141
36190	287, 310	365380	288	369424B	301	38706C	141
36192	287, 310	365408	294	369425B	301	38800GLC	131
36193	287, 310	365450	274	369430	301	38820C	130
36197	287, 310	365501	267	369442B	301	38830C	130
362013	295	36552	263	369448B	301	38850GEW	130
3620194	278-279, 294	36567	291, 311	369454B	301	388804L	131
3620294	278-279, 294	36568	291, 331	369460	301	38882G	130
36204818	283, 310	36592	292	369472B	301	38883G	130
36204824	283, 310	36596	292	369475	305	38884G	130
36207218	284, 310	366318	290, 311	369478B	301	3956	207
36207224	310	366324	290, 311	369484B	301	3957	207
36211	273	36633	280	369551B	301	3958	207
362113	295	366330	290, 311	369552B	301	3959	207
36219618	282	36634	281	369595	306	3960	207
36219624	282	366824	290, 311	369670B	302	3961	207
36219663	288	366918	290, 311	369674B	302	3970	207
362208P18	283, 310	366922	290, 311	36968	306	3971	207
362208P24	283, 310	3672231	326	36970	305	3980	207
36232	309	36752	267	369724	303	3981	207
36233	309	367600TC	267	369732	303	3990	207
36236	286	367618	284, 310	369811B	303	3991	207
36239	270	367624	284, 310	369814B	303	3992	207
36275	287, 310	367818	291, 311	369816B	303	3993	207
36289	265	3682	280	369817B	303	4000	260
36292	287, 310	36853	279	369819B	303	40001	260
363156	274	36854	279	369820B	303	40002	260
36324C	291, 311	36859	279, 310	369824B	303	40003	260
3633	309	36860	279, 310	369832	303	40004	260
3633019	298	36861	278	36990	305	40005	260
3633118	297	36863	279, 310	36990R	305	40006	260
3633124	297	36864	279, 310	381109LG	128	40007	260
3633136	297	36865	278	381206LG	128	40008	260
3633218	297	36867	278	3812CH	198	40010	260
3633224	297	36868	278	3812CM	198	40020	270
36333	274	36873	279	3812MP	198	40021	270
36334	274	36874	279	3816	213	40022	270
3633519	297	36883	279, 310	3816CH	198	40023	270
3633525	297	36884	279, 310	3816MP	198	40024	265
3633537	297	36885	278	3816WH	198	40025	263
36336C	291, 311	36900	307	3817	213	40026	268
3633670	297	369024C	304	38180A	198	40027	269
363404	274	369024R	304	3820CH	198	40028	264
363725	268	36904	307	3820MP	198	40040	264
36396	267	36905	307	38240A	198	40042	264
36399	286	369066B	304	38310	128	4006	120
36400	286	369070B	304	38322BH	140	40070	275
36439	309	369074B	304	38332BH	140	40071	275
3647248	298	36908	307	38342BH	140	40074	275
3647524	298	36908C	307, 321	38360	198	40075	292, 311
3647536	298	36908W	307	38360A	198	40076	292, 311
3647548	298	369082	304	38480	198	40077	292, 311
36490	298	36909	307	38480A	198	4008	42
36490R	298	36910	326	38502	129	40081	289, 311
365015	272	36911	326	38503	129	40082	289, 311
36505	272	36917	325	38504	129	40083	289, 311
36505L	272	369210	327	38600R	116	4009	120
36509L	272	369320	302	38601	129	4010	42
365117	275	369365	306	386010	129	40107	289
365120	275	369375	306	386230IB	129	40108	289
36513	272	36941	307	38623IB	129	40109	289
36513L	272	369412B	301	38655	28, 115	40110	262
365300	288, 310	369418B	301	38704C	141	40111	262
365310	288, 310	369419B	301	38704CNS	141	40112	262

# PRODUCT INDEX

Prod No	Page No	Prod No	Page No	Prod No	Page No	Prod No	Page No
40113	262	40361	210	40673	263	43002	15
40114	262	40361C	211	40674	266	43004	15
40115	262	40362	210	40675	266	43006	15
4012	42	40370	200	40676	266	43008	15
40120	262	40371	200	40681	212	43010	15
40121	262	40372	200	40682	212	43012	15
40122	262	40373	200	40710	269	43016	15
40123	262	40374	200	40711	269	43018	15
40140	309	40375	200	40712	269	43024	15, 84
40144	308	40376	200	40713	269	43030	15
40146	308, 311	40377	200	40724	288	43032	15
40147	308, 311	40378	201	40725	288	43034	15
40148	308, 311	40379	201	40728	266	43036	15
40150	264	40380	200	40729	266	43038	15
40152	264	40390	202	40731	296	43040	15
40153	263	40391	202	40732	296	43042	15
40154	263	40392	202	40733	296	43050	15
40155	263	40393	202	40735	296	4306	145, 147, 199
40156	263	40394	202	40737	296	43066	48
40157	263	40395	201	410	56	43068	48
4016	42	40396	201	41020	293-294	43080	15
40164	203	40397	201	41027	275	43082	15
40180	263	40398	201	41076	213	43086	15
4020	42	40399	201	41076-1	213	43121	59
40210	293	40400	201	41077	213	43122	59
40220	293	40401	201	41077-1	213	43123	59
40224	294	40402	201	41082	278	43125	58
40225	293	40403	202	41083	278	43126	59
40227	293	40405	202	4109	120	43141	204
40230	294	40412	203	41093	308, 311	43142	204
40232	294	40413	267	41169	262	43143	204
40233	294	40415	261	41199C	293	43144	204
40236	308	40422	287, 310	412	56	43145	204
40237	308	40423	287, 310	41225	278-279, 293	4315	204
40261	295	40424	309	41226	293	4322	206
40262	295	40425	309	41270	266	4324	206
40267	295	40430	288, 310	41291	293	4326	206
40271	295	40460	261	41323	289, 310	4328	206
40275	295	40461	261	41349	280	4329	206
4029	42	40462	261	41350	280	4330	206
40290	268	40465	261	41352	280	43304	26
40291	268, 275	40466	261	41354	280	43306	26
40293	268, 275	40467	261	414	56	43308	26
40294	268	40468	261	41506	261	4332	199
40300	305	40480	273	41520	268	43410	25
40301	305	40481	273	41567	290, 311	43420	25
40305	305	40485	273	41568	290, 311	43422	25
40306	305	40500	271	41664	306	43500	19
4033	45	40501	271	41672	298	43501	19
4034	45	40521	260	41673	298	43503	19
40340	306	40529	265	41679	281	43504	19
40345	304	40532	265	41680	281	43505	19
40347	210	40541	271	41683	281	43512	19
40349	210	40542	271	41880	282, 310	43514	19
4035	45	40545	271	41881	282, 310	43516	19
40350	210	40546	271	4206	120	43520	19
40350C	211	40561	283, 310	4230	208	43521	19
40351	210	40562	283, 310	4231	208	43522	19
40352	210	40564	283, 310	4250	208	43525	19
40352C	211	40565	283, 310	4251	208	43528	19
40353	210	40634	280	4260	208	43529	19
40354	210	40650	278	4261	208	43531	19
40355	210	40670	269	4270	208	43532	19
40356	210	40671	269	4271	208	43533	19
40359	210	40672	269	43000	15	43540	19

# PRODUCT INDEX

Prod No	Page No	Prod No	Page No	Prod No	Page No	Prod No	Page No
4355	121	43854	23	44522	83	4968	207
43560	19	43856	23	44524	83	500B	30
43563	19	43858	23	4460	121	500M	30
4358	206	43860	23	4470	121	509	121
4360	206	43862	23	4471	121	5105-2	45
4360-5	206	43864	23	4512	31, 48	5108-2	45
4361	206	43866	23	45222	284, 310	5109-2	45
4362	206	43868	23	45259	294	5109L	53
43620	44	43872	23	45267	295	5116-2	45
43621	44	4390	206	4530	28	5120	45
43622	44	4390-5	206	4531	28	5212	39
43623	44	4391	206	4532	28	5212-2	39
43624	44	43937	39	4533	28	5212L	53
43625	44	43942	57	4534	28	5216	39
43626	44	43943	57	4535	28	5216C203	40
43627	44	43944	57	45411	273	5216IB203	40
43628	44	43965	48	45463	264, 272	5216RB203	40
43629	44	43980	159	4549	60	5216-2	39
43630	44	43981	159	45493	264, 272	52163550D	40
43631	44	43982	159	4550	60	52163550E	40
43633	46	43983	159	4551	60	52163841A	40
43635	46	43984	160	4553	58	52163841F	40
43636	46	43986	160	45571	269	5216841C2	40
43637	46	43988	159	4560	60	5220	39
43638	46	43989	159	4563	60	5220C203	40
4364	199	439945200	43	45643	281	5220IB203	40
43640	46	44010	253	45649	281	5220RB203	40
43647	41	44010SKD	253	45733	274	5220-2	39
43648	41	44011	253	4575	61	52203550	40
43649	41	44011SKD	253	45772	268	52203550A	40
43651	41	44012	253	45779	269	52203841B	40
43653	41	44030	62	45781	266	52203841G	40
43655	41	44031	62	45850	295	5220841C2	40
43662	46	4410	121	4606	120	5224	39
43663	46	4411	121	4609	120	5224C203	40
43664	46	4415	213	4650	61	5224IB203	40
43665	46	4416	213	4651	61	5224RB203	40
43666	46	4420	121	4709	120	52243550G	40
43668	46	4421	121	4712	120	52243550H	40
43674	46	4425	213	4806	120	52243841C	40
4370	206	4426	213	4900	213	52243841H	40
4370-5	206	4430	121	49110-1	203	5224841C2	40
4371	206	4431	121	49112-1	203	5232	39
43737	86	44400	84	49116-1	203	5232C203	40
43738	86	44402	84	49122-1	203	5232IB243	40
43739	86	44404	84	4921	207	5232RB203	40
43743	209	44406	84	4922	207	5232-63550J	40
43744	209	44410	84	4923	207	5232-63550I	40
43745	86	44410C	85	4924	207	52323841I	40
43772	86	44412	84	4925	207	5232841C2	40
4380	206	44414	84	4926	207	52412L	53
4380-5	206	44414C	85	4927	207	53000	8
43800	27	44416	84	4928	207	53001	8
43801	27	44418	84	4929	207	53002	8
43803	27	44420	85	4930	207	53003	8
43806	27	44422	85	4931	207	53004	8
4381	206	44430	85	4932	207	53005	8
4381-5	206	44432	85	4933	207	53006	8
43813	27	44432C	85	4961	207	53007	8
43814	27	44460	85	4962	207	53008	8
43822	27	44462	85	4963	207	53009	8
43840	86	4450	121	4964	207	53010	8
43842	86	44514	83	4965	207	53011	8
43850	23	44518	83	4966	207	53101	9
43852	23	44520	83	4967	207	53102	9

# PRODUCT INDEX

Prod No	Page No	Prod No	Page No	Prod No	Page No	Prod No	Page No
53103	9	5616	36	60204	100	60700HL6	225
53104	9	5640	37	60205	100	60700HLC	225
53105	9	5641	37	60206	100	60708RS	183
53106	9	5642	37	60207	100	6071A	225
53107	9	5643	37	60208	100	60710RS	183
53108	9	5644	37	60209	100	60712RS	183
53109	9	5645	37	60210	100	607120C	225
53110	9	5646	37	60211	100	607120CS	225
54001	11	5648	37	602202	225	607122	225
54002	11	5649	37	602203	225	607122P	225
54003	11	5650	37	602400	59	607124P	225
54004	11	5651	37	602424	190	607124	225
54005	11	5652	37	602500	59	607126	225
54007	11	575B	30	60275	209	607130C	225
54018	11	575M	30	60277	209	607130CS	225
54019	11	5806	41	60278	209	607132	225
5501	39	5808	41	60279	209	607134	225
5501-2	39	5810	41	60280	209	607136	225
5505	43	5810L	53	60300-10	205	607140C	225
5506	39	5812	41	60300-12	205	607140CS	225
5506L	53	5812L	53	60300-16	205	607142	225
5506-2	39	5814	41	60300-20	205	607144	225
5508	43	5816	41	60300-24	205	607146	225
5509	43	5818	41	60300-30	205	607160C	225
5512	43	5820	41	60300-40	205	607160CS	225
5517	43	5822	41	60300-6	205	607162	225
5519	43	5822L	53	60300-8	205	607164	225
5526	39	5832	41	60306	188	607166	225
5526-2	39	5865	159	6031	208	607190C	225
5529	39	5933	27, 86	60344	189	607190CS	225
5529-2	39	600295	101	60345	189	607192	225
5532	39	600296	101	60346	189	607194	225
5532-2	39	60100PC	185	604144	190	607230C	225
5536	49	601000	187	604174	190	607232	225
5538	49	601001	187	604360	205	607236	225
5540	49	601002	187	604361	205	607550	212
5544	49	601003	187	604370	205	607552	212
5546	49	60101	185	604371	205	607556	212
5547	49	60102	185	604380	205	607560	212
55520	80	601028	187	604381	205	607562	212
55522	80	601029	187	604390	205	607566	212
55524	80	60103	187	604392	205	607680	102
55526	80	601031	187	604460	101	607682	102
55528	80	601306	191	604606	101	607683	102
55530	80	601526	208	604609	101	607685	102
55532	80	601527	208	606040	199	607687	102
55534	80	601528	208	606055	199	607690	102
55536	80	601529	208	606086	199	607691	102
55538	80	601642	191	606106	145, 147	607692	102
55540	80	601647	191	606902	190	607693	102
55542	80	601824	191	606903	190	607695	102
55544	80	601825	191	6070A	225	607697	102
55546	80	601826	191	607000C	225	608002	225
55550	80	601828	191	607000CS	225	608004	225
5570	50	601829	190	607000H	225	608006	225
5573	50	601830	190	607001	225	608122	225
5583	50	601834	190	607002	225	608124	225
5587	50	601837	190	607002D	225	608126	225
5601	36	601840	190	607002P	225	608132	225
5602	36	601922	188	607004	225	608134	225
5603	36	601923	188	607004P	225	608136	225
5609	36	60200	100	607006	225	608142	225
5610	36	60201	100	607006P	225	608144	225
5612	36	60202	100	60700HL2	225	608146	225
5614	36	60203	100	60700HL4	225	608162	225

# PRODUCT INDEX

Prod No	Page No	Prod No	Page No	Prod No	Page No	Prod No	Page No
608164	225	609316	104	6527	63	7208	97
608166	225	60934	185	6528	63	7210	97
608192	225	61115	184	6529	63	7212	97
608194	225	61120	184	6531	91	7215	97
608236	225	61120C	186	6532	91	7218	97
60830	209	61125	184	6534	91	7223	97
608600	146	61125C	186	6550	62	7400	31
608901	164	61130	184	6551	62	7405	31
608902	164	61130C	186	6552	62	7420	31
608904	164	61210	184	6553	62	7550	137
608905	164	61210C	186	6600	125	7555	137
608907	164	61212	184	6601	125	7670	126
608908	164	61216	184	6605	125	7671	126
608909	164	61216C	186	6606	125	7711	123
608913	164	61220	184	6608	125	7721	123
608918	164	61220C	186	6611	125	7725	123
608919	164	61224	184	6620	125	7910	89
608924	30	61224C	186	6621	125	7913	89
609001	101	61232	184	6625	125	7914	89
609002	101	61232C	186	6713	92	7916	89
609005	101	61240	184	6716	92	7918	89
609006	101	61240C	186	6723	92	7919	89
609007	101	61260	184	6726	92	7920	89
609009	101	61260C	186	6843	99	7930	87
60907C	186	614	159	6863	99	7932	87
60907RS	183	614PC	159	6904	29	7934	87
60907SERS	182	614R	159	6907	29	7940	26
60907XRS	182	615	159	6908	95	7942	26
60908C	186	61702	185	6909	95	7944	83
60908RS	183	61702C	186	6914	95	7946	83
60908SERS	182	61704	185	6917	95	7948	83
60908XRS	182	61704C	186	6919	95	800B	30
60910C	186	61707	185	6931	95	800M	30
60910RS	183	61707C	186	6942	95	8004	48
60910SERS	182	61708	185	6947	95	8038	96
60910XRS	182	61708C	186	6954	29	8099	96
609106	147	61710	185	6956	29	8100	96
609107	146	61710C	186	6963	90	8104	48
60912C	186	6302FMT	156	6966	90	8110	94
60912RS	183	630FMT	156	6982	93	8112	94
60912SERS	182	63910L	53	6982L	93	830FMT	156
60912XRS	182	63912L	53	6984	93	8302FMT	156
609131	66	6400	203	6984L	93	8821	94
609132	66	64001	12	69844	93	8886	92
609133	66	64002	12	69846	93	8887	92
60914C	186	64003	12	6986	93	8888	92
60914RS	183	64005	12	69864	93	8919	89
60914SERS	182	64007	12	69866	93	8920	89
60914XRS	182	6401	203	6988	93	9051	126
609143	146	64013	12	6990	93	9052	126
609146	146	64018	12	7000	47	91020	32
609190	147	64020	12	7006	31	91040	32
609191	147	64022	12	7008	31	91055	32
609193	147	64023	12	7038	119	91065	32
609201	98	6413	165	7039	119	91070	32
609202	98	6416	165	70900	47	91075	32
609203	98	6417	165	70901	47	91080	32
609204	98	6426	165	70902	47	91085	32
609209	98	6439	165	70903	47	91090	32
60921	185	6450	165	70904	47	91095	32
609211	98	650B	30	70905	47	9148	126
609216	98	650M	30	7110	67	9160	126
609270	51	6504	63	7111-4	67	9172	126
609273	51	6524	63	7112	67	9224	126
609310	104	6526	63	7206	97	9248	126



# PRODUCT INDEX

Prod No	Page No	Prod No	Page No	Prod No	Page No	Prod No	Page No
9260	126	CM1042	113	GA55013	13	IC2250T	179
9272	126	CM1042LP	113	GA55014	13	IC2254	179
9710	126	CM1043	113	GR09	144	IG224	147
9712	126	CM1045	113	GR10	144	IT1000	170
9720	126	CM1046	113	Group A	33	IT140	171
9722	126	CM1049	113	Group AT	33	IT160	171
ADD4	319	CM1058	117	Group B	33	IT180	171
ADD6	319	CM1065	117	Group BT	33	IT250	170
ADDC	319	CM1069	117	Group C	33	IT400	171
ADDD	319	CM1100	111	Group CT	33	IT410	171
ADS4	319	CM1100C14	108	Group D	33	IT500	170
ADS8	319	CM1101	111	Group DT	33	JC1945CB	321
ADSC	319	CM1101C14	108	Group E	33	JC1945L	321
ADSD	319	CM1102	111	Group ET	33	JC1945S	321
ARR112	86	CM1102C14	108	Group P1	33	JC1946	321
ARR120	86	CM1103	111	Group P1T	33	KL102	21
ARR240	86	CM1103C14	108	Group P2	33	KL108	21
BC05	142	CM1104	111	Group P2T	33	KL115	21
BIN27	233	CM1104C14	108	Group P3	33	KL116	21
BIN27L	233	CM1105	111	Group P3T	33	KL118	21
BIN36	233	CM1105C14	108	Group P4	33	KL119	21
BIN36L	233	CM1107	110	Group P4T	33	KL121	21
BIN44	233	CM1108	110	HAL01	10	KL123	21
BIN44L	233	CM1125	111	HAL02	10	KL126	21
C111	248	CM1126	111	HAL03	10	KL127	21
C135	248	CM1127	111	HAL04	10	KL200	21
C2220A	249	CM1128	111	HAL05	10	KL201	21
C2222A	249	CM1400	115	HAL06	10	KL203	21
C2222C	249	CM1401	115	HAL09	10	KL204	21
C2222HD	249	CM1402	115	HAL10	10	KL205	21
C2236	249	CM1403	115	HAL11	10	KL350	21
C2236H	249	CM1404	115	HAL12	10	KL444	160
C2237	249	CM1405	115	HAL13	10	KL800	21
C32P1	248	CM1406	115	HAL14	10	KL805	21
C32P2	248	CM1407	115	HAL15	10	KL920	21
C35P	248	CM1408	115	HAL16	10	KL924	21
C3620W	165	CP2036	316	HAL17	10	KL928	21
C3625T	165	CT1014	157	HAL18	10	LB12	96
C3630W	165	CT1216	157	HAL20	10	LB16	96
C93	248	CT1217	157	HAL21	10	LD1000N	175
CC11SH	316	CT1418	157	HAL22	10	LD250N	175
CC11TH	316	CT1713TR	157	HAL23	10	LD350N	177
CC2036	316	CW6C	248	HAL24	10	LD500N	175
CC2036DP	316	DL1826	178	HAL26	10	LD500NSS	177
CC2036P	316	DL300	178	HAL27	10	MIN5440	38
CC2243	316	DL300R	178	HAL28	10	MIN5441	38
CD2036	316	EAG01	88	HAL31	10	MIN5442	38
CM1012	28, 115	EAG02	88	HAL32	10	MIN5443	51
CM1013	28, 115	EAG04	88	HL7237	197	MIN5449	38
CM1017	117	EAG05	88	HL7237PS	197	N44010	252
CM10238Z	112	EAG06	88	HL8185	197	N44011	252
CM10239Z	112	EAG07	88	HL8185B	197	N44012	252
CM10240Z	112	EAG08	88	HL8185C	197	OP305	144
CM10278Z	112	EAG09	88	HL8185G	197	OP316	144
CM10279Z	112	EAG10	88	HL8185GB	197	OP371	144
CM10280Z	112	EAG11	88	HL8185GC	197	OSB172	97
CM1030	116	EP214	144	HL8195	197	OSB176	97
CM10318Z	112	EP216	144	HL8195B	197	OSB178	97
CM10319Z	112	EP217	144	HL8285	197	P614	159
CM1032	116	GA55001	13	HL8285B	197	P614R	159
CM1033	116	GA55002	13	HL8285G	197	PC140N	177
CM1033P	116	GA55003	13	HL8285GB	197	PC160N	177
CM1035	116	GA55008	13	HLA20	197	PC180N	177
CM1037	116	GA55011	13	IC2220	179	PC300N	176
CM1040	113	GA55012	13	IC2250	179	PC600N	176

# PRODUCT INDEX

Prod No	Page No	Prod No	Page No	Prod No	Page No	Prod No	Page No
PC660	176	REW30S	241	RSP	247	SL6011TC	103
PCD205	24	REW30SC	241	RST1520NSQ	161	SMMC10	105
PCD206	24	RF	246	RTP	246	SMMC12	105
PCD207	24	RFP	247	RW20	241	SMO1624	105
PCD209	24	RG16	243	RW20-C	241	SMR1624	105
PCD210	24	RG16-1	243	RW20-1	241	SMR1836	105
PCD211	24	RG16-1C	243	RW20-1C	241	SMR24	105
PCD220	24	RG16-2	243	RW20-2	241	SMTD24	105
PCD305	24	RG16-2C	243	RW20-2C	241	SPD123	127
PCD308	24	RG16-3	243	RW20-3	241	SPD300	127
PCD310	24	RG16-3C	243	RW20-3C	241	SPD300KD	127
PCD312	24	RG16-4	243	RW20-4C	241	SPD303	127
PCD313	24	RG16-4C	243	RW30	241	SPD303KD	127
PCD316	24	RG16-5	243	RW30-C	241	SS105	141
PCD319	24	RG16-5C	243	RW30-1	241	SSD100	131
PCD412	24	RG25	244	RW30-1C	241	SSW1	103
PCD796	24	RG25-1	244	RW30-2	241	ST1532	230
PCD801	160	RG25-1C	244	RW30-2C	241	ST1544	230
PS101CS	142	RG25-2	244	RW30-3	241	ST1556	230
PS103	139	RG25-2C	244	RW30-3C	241	ST1568	230
PS103AT	139	RG25-3	244	RW30-4C	241	ST1573	230
PS203	139	RG25-3C	244	S275	58	ST1587	230
PS204	138	RG25-4	244	S277	58	ST1629	230
PS204AST	138	RG25-4C	244	S279	58	ST1630	230
PS304	139	RG25-5	244	S280	58	TC1826N	177
PS304AT	139	RG25-5C	244	S282	58	TP100	131
PS501N	139	RG36	245	S285	58	TTH100	333
PS502N	139	RG36-1	245	S286	58	TTL100	333
PS6012	139	RG36-1C	245	S287	58	TTL150	333
PS601N	139	RG36-2	245	S310	56	TTL580	333
PS601NC	138	RG36-2C	245	S312	56	TTLD580	333
PS602N	139	RG36-3	245	S314	56	TTS100	333
PS603N	139	RG36-3C	245	SB66	97	TTS150	333
PS701B	139	RG36-4	245	SB68	97	TTS580	333
PS702	139	RG36-4C	245	SB70	97	UC1940	318
PS801B	139	RG36-5	245	SB72	97	UC3031524	317
PS802	139	RG36-5C	245	SB74	97	UC3031827	317
PSD13CH	99	RG49	245	SB76	97	UC4018	318
PSD13EH	99	RG49-1	245	SB78	97	UC4031529	317
PSD21CH	99	RG49-1C	245	SB79	97	UC4031733	317
PSD21DEH	99	RG49-2	245	SB90	96	UC4525	318
PSD21EH	99	RG49-2C	245	SB94	96	UC5031524	317
RB	246	RG49-3	245	SBC11SH	317	UC5031827	317
RC16	247	RG49-3C	245	SBC11TC	317	UC5032135	317
RC16-1	247	RG49-4	245	SBC1521	315	UC7022133	317
RC20	247	RG49-4C	245	SBC2031	315	UC7032133	317
RC20-1	247	RG49-5C	245	SBC230	317	UCC4018	318
RDC	249	RG9	242	SBCA30000	315	UCC4525	318
RDC1	249	RG9-1	242	SBCC240	315	WB965	63
RE	242-246	RG9-1C	242	SBCC245	315	WPM25	145
RE16	243	RG9-2	242	SBCRKIT	315	WPM45	145
RE16C	243	RG9-2C	242	SBG1	103	WPM85	145
RE25	244	RG9-3	242	SC25	160	XB5	172
RE25C	244	RG9-3C	242	SC26	160	XDL3000H	178
RE36	245	RG9-4	242	SC27	160	XT10000	174
RE36C	245	RG9-4C	242	SC29	160	XT1400	173
RE49	245	RG9-5	242	SC32	99	XT1600	173
RE49C	245	RG9-5C	242	SC40	160	XT1800	173
RE9	242	RHC	249	SCL1	103	XT2500	174
RE9C	242	ROP	246	SD01	103	XT3000R	173
REW20S	241	RP	246	SEA1	103	XT5000	174
REW20SC	241	RPC	247	SL6011L	103		



**CFS**BRANDS<sup>®</sup>

CAT2019FSP