



Utility Carts



Crystal Clear Bins



Wire/Solid Shelving



Wall Mounted Systems



Bussing Tubs



Polymer Shelving



Mobile Organizers



Pizza Dough Boxes



Security Units



Cantilever Systems

PRODUCT CATALOG

- | Wire Shelving | Bussing Tubs & Proofing Boxes | Food Grade Totes
- | Polymer Antibacterial Shelving | Plastic Bins | Transportation Carts
- | FREE Freight Programs | CAD/Layout/Design Services

Export Representatives:
MBH International Sales, Inc.
 4907 SW 75th Ave.
 Miami, FL 33155 USA
 Phone: (305) 669-1894
 Fax: (305) 669-1797
sales@mbhny.com
www.mbhny.com



Located in Miami, Florida, Quantum is one of the largest injection molding companies with 75 molding presses. We offer **the largest selection of storage and organization products in the industry**. Injection molding the highest quality bins and containers in the industrial, material handling, healthcare, hospitality, food service & hardware industries, Quantum is the leader in providing organization and complete storage solutions.

- Our facility is 1.5 million square feet in manufacturing and distribution space with over 450 employees.
- Our manufacturing facility supports 275 full time employees and runs 24 hours a day, 7 days a week. We supply over 68,000,000 bins inside North America annually.
- Offering over 25,000 product skus to our customers, Quantum stocks each item in our Florida and Illinois warehouses. 99% of products are available to ship within 24 hours from receipt of order.
- Quantum plastic products are all manufactured using FDA approved materials as well as products meeting NSF requirements for the healthcare and food service industries.

OUR MISSION

First Class Quality

Product Always in Stock

Pre & Post Order Customer Care

Guaranteed Low Prices

COLOR/FINISHES OPTION ORDERING INSTRUCTIONS

In order to properly process your order, please include a color/finish code suffix to any model number available with color/finish options. Use one or two letter abbreviations listed below and add them to the end of the model number without any spaces or dashes. (i.e. *QSB101* in Blue would be submitted as *QSB101BL*).

BIN COLORS:

- | | | | |
|------------------|------------------|------------------|-------------------------|
| RD Red | YL Yellow | BK Black | BN Brown |
| BL Blue | GN Green | IV Ivory | CL Clear |
| SN Stone | WT White | GY Gray | CC Crystal Clear |
| OR Orange | PU Purple | CM Custom | |

WIRE FINISHES:

- | | | | |
|--------------------------------|--------------------|----------------------------|---|
| P Green | GY Gray | BK Black | SG Galvanized |
| C Chrome* | S Stainless | SS Solid Stainless* | |
| WPM Green/Plastic Green | | | *Some products do not require suffix to be included |

ICON DESCRIPTIONS

- | | | | |
|--------------------------|-----------------------|---------------------------------|--|
|
NSF Approved |
Dishwasher Safe |
CA Prop 65 Approved |
HACCP Approved |
|
Ships All in One Box |
Non-Stocked Items |
Parcel Carrier (UPS, FedEx) |
Made in the United States of America |



STORAGE

- 10 Millenia Shelving
- 11 Millenia Shelving
- 12 Millenia Shelving - Shelves and Posts
- 13 Millenia Shelving - Vented Shelf Units
- 14 Millenia Shelving - Solid Shelf Units
- 15 Millenia Shelving - Mix Shelf Units
- 16 Millenia Shelving - Accessories
- 17 Millenia Shelving - Accessories & Platforms
- 18 Millenia Shelving - Drying Racks
- 19 Polymer Wire Shelving
- 20 Polymer Wire Shelving - Shelves & Posts
- 21 Polymer Wire Shelving - Units
- 22 Polymer Wire Shelving - Drying & Can Rack Units
- 23 Polymer Wire Shelving - Accessories
- 24 Wire Shelving - Shelves
- 25 Wire Shelving - Posts
- 26 54" Wire Shelving Units
- 27 63" Wire Shelving Units
- 28 74" Wire Shelving Units
- 29 86" Wire Shelving Units
- 30 Wire Shelving - Accessories
- 31 Wire Shelving - Accessories
- 32 Wire Shelving - Accessories
- 33 Wire Shelving - Accessories
- 34 Wire Shelving - Accessories
- 35 Wire Shelving - Accessories
- 36 Solid Shelving
- 37 Solid Shelving - Shelves and Posts
- 38 Solid Shelving - Galvanized Steel Units
- 39 Solid Shelving - Galvanized Steel Units
- 40 Solid Shelving - Stainless Steel Units
- 41 Solid Shelving - Stainless Steel Units
- 42 Stem Caster Carts
- 43 Stem Caster Carts
- 44 Enclosure Carts
- 45 Enclosure Carts
- 46 Cart Covers
- 47 Retail Units - 1 Box Wire Shelving
- 48 Retail Units - 1 Box Millenia Shelving
- 49 Retail Units - 1 Box Polymer Wire Shelving
- 50 Specialty Storage - Security Units
- 51 Specialty Storage - Corner Wire Shelving
- 52 Specialty Storage - Cantilever & Dunnage Shelves
- 53 Specialty Storage - Shelves & Frames
- 54 High Density Storage - Overhead Track System
- 55 High Density Storage - Overhead Track System
- 56 High Density Storage - Floor Track System
- 57 High Density Storage - Floor Track System

PREPARATION & COOKING

- 58 Store Grid Mounted Systems
- 59 Store Grid Mounted Systems
- 60 Store Grid Mounted Systems
- 61 Store Grid Mounted Systems
- 62 Store Grid Mounted Systems
- 63 Store Grid Mounted Systems
- 64 Store Grid Mounted Systems - Accessories
- 65 Wall Shelving - Cantilever Systems
- 66 Wall Shelving - Cantilever Systems
- 67 Wall Shelving - Cantilever Systems

TABLES & WORKSTATIONS

- 68 Tables & Drive-Thru Station
- 69 Stainless Steel Shelf Covers & Custom Stations

RECEIVING

- 70 Polymer Dunnage Racks
- 71 Dunnage & Platforms Racks
- 72 Dunnage & Platforms Racks
- 73 Keg Racks

HOUSEKEEPING / MERCHANDISING / DISPLAY

- 74 PARTition Wall Systems
- 75 PARTition Wall Systems
- 76 PARTition Wall Systems - *Accessories*
- 77 Bin Carts
- 78 Slanted Shelf Carts
- 79 Slanted Shelf Carts
- 80 Wine Cradle Shelves, Units & Carts
- 81 Wine Cantilevers, Bulk & Security Units
- 82 Garment Racks
- 83 Mobile To Go & Organizers

RESTAURANT CHAIN

- 84 Pizza Dough Boxes
- 85 Meat Lugs
- 86 Modular Trays & Tray Carts

CLEANING & SANITATION

- 87 Bussing Tubs & Utility Boxes
- 88 Utility Carts
- 89 Polymer & Push Handle Wire Utility Carts
- 90 Drying Racks
- 91 Tool Caddy, Tool Box, Nesting Parts Bin & Wrench Holder

PLASTIC STORAGE

- 92 Ultra Stack & Hang Bins
- 93 Ultra Stack & Hang Bins
- 94 Giant Open Hopper Steel Shelving Systems
- 95 Giant Open Hopper Wire Shelving Systems
- 96 Crystal Clear Ultra Hang & Stack Bins
- 97 Super Tuff Euro Drawers
- 98 Mesh Stack & Hang Bins
- 99 Wire Louvered Panels
- 100 Stackable Shelf Bins
- 101 Stackable Shelf Bin Shelving Systems
- 102 HULK 24" Containers
- 103 HULK 24" Containers Wire Shelving Systems
- 104 HULK 30" & 36" Containers
- 105 HULK 30" Container Wire Shelving Systems
- 106 HULK 36" Container Wire Shelving Systems
- 107 Collapsible Bulk Box
- 108 RackBin 42" Containers
- 109 RackBin 42" Container Wire Shelving Systems
- 110 Giant Stack Containers
- 111 Giant Stack Containers Wire Shelving Systems
- 112 MAGNUM Bins
- 113 MAGNUM Bin Wire Shelving Systems
- 114 Economy 4" Shelf Bins
- 115 Economy 4" Shelf Bin Wire Shelving Systems
- 116 High Density Wire Shelving Systems
- 117 Store-More 6" Shelf Bins
- 118 Store-More 6" Shelf Bin Wire Shelving Systems
- 119 Store-Max 8" Shelf Bins
- 120 Store-Max 8" Shelf Bin Wire Shelving Systems
- 121 QuickPick Bins & Wire Shelving Systems

BULK CONTAINERS

- 122 Latch Containers & Wire Shelving System
- 123 Dividable Grid Containers

- 124 Genuine stack and nest totes
- 125 Wire Shelving Systems
- 126 Stacker Straight Wall Containers
- 127 Attached Top Distribution Containers
- 128 Labels

ORGANIZERS

- 129 Plastic Drawer Cabinets
- 130 Clear Compartment Storage Boxes
- 131 Organizers
- 132 Clear Tip Out Bins
- 133 Dividable & Individual Clear Tip Out Bins
- 134 Layout & Design Services
- 135 Terms and Conditions

WHY QUANTUM FOOD SERVICE?

-  **RELIABLE IN-STOCK INVENTORY**
-  **SUPER FAST-SAME & NEXT DAY SHIPMENTS**
-  **LAYOUT & DESIGN SERVICES INCLUDED**
-  **LARGEST SELECTION OF WIRE & BINS**

The most efficient, permanent, and economical solution to solve your exact storage needs!



NEW PRODUCTS

**OUR PRODUCT OFFERING
KEEPS GROWING!**



MILLENNIA DRYING RACKS
pg. 18



WINE CARTS & SECURITY UNITS
pgs. 80-81



BUSSING TUBS/UTILITY BOXES
pg. 87



POLYMER DUNNAGE RACKS
pg. 70



GREEN POLYMER DRYING RACKS & CAN RACKS
pg. 22

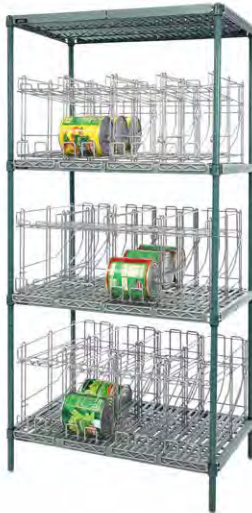

STORE GRID KITS
pgs. 60-63



PUSH HANDLE CARTS
pg. 89



PIZZA DOUGH BOXES
pg. 84



DRIVE-THRU STATION
pg. 68



CRYSTAL CLEAR ULTRA HANG BINS
pg. 96



MOBILE & COUNTER TOP INGREDIENT ORGANIZERS
pg. 83



MOBILE TO GO
pg. 83



SNEAK PEEK

of what's **COMING SOON** at **Quantum Food Service!**

FOOD PANS

Cold - Hot



BUCKETS/PAILS



FOOD STORAGE BOXES

Boxes - Lids - Colander/Drain Grate



TRASH CANS

Commercial - Space Savers
- Waste Baskets



INGREDIENT BINS

Bulk w/Lid & Dolly - Mobile w/Slant Top
- Shelf Ingredient Bin





AVAILABLE IN 8 FINISHES AND 3 LIMITED WARRANTIES



▶ **Chrome** - is a plating process which deposits hard chrome over a copper, nickel surface. This process is very durable and allows product to be used in any application in a dry storage environment. **1 year limited warranty to not rust or corrode when used in dry and non-humid environments.**

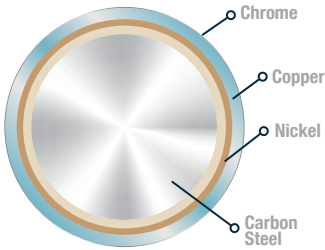

▶ **Galvanized Steel** - is a manufacturing process where a coating of zinc is applied to steel to offer protection and prevent rusting. The zinc protects the base metal by acting as a barrier to corrosive elements. **1 year limited warranty to not rust or corrode when used in dry and non-humid environments.**

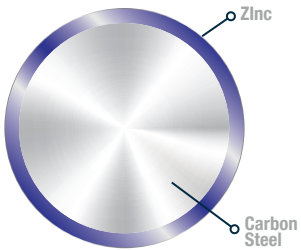

▶ **Proform Green, Gray and Black Epoxy** - are an ideal solution for high humidity, wet, or walk-in-cooler applications. The carbon steel is treated with an iron phosphate and the powder coated epoxy is electrostatically applied, baked and cured to a hard surface. All three colors are antimicrobial. **15 year limited warranty for antimicrobial finish to not rust or corrode.**

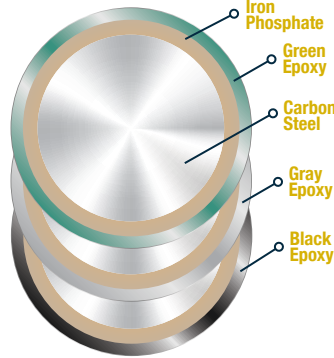

▶ **Proform Green Polymer** - is an ideal solution for high humidity, wet, or walk-in-cooler applications. The carbon steel is treated with an iron phosphate and the powder coated epoxy is electrostatically applied, baked and cured to a hard surface. All three colors are antimicrobial. Plastic mats are virgin grade Polypropylene. **15 year limited warranty for antimicrobial finish to not rust or corrode. Limited lifetime on polymer shelf mats.**

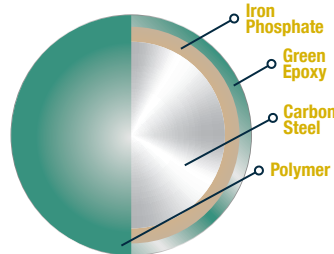

▶ **Stainless Steel** - 304 Stainless with an electro-polish finish represents the highest industry standard in the prevention of corrosion. This finish is highly effective for corrosive, high humidity or clean room environments. **Lifetime limited warranty for 304 stainless steel electro-polish finish to not rust or corrode.**

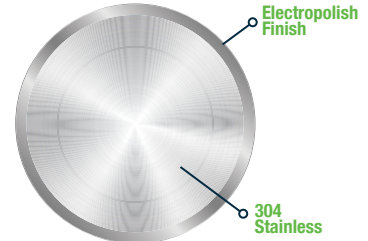

▶ **Millenia Polymer** - all polymer, the best industry standard in the prevention of corrosion. This finish is highly effective for corrosive, high humidity or clean room environments. **Lifetime limited warranty to no rust or corrode.**

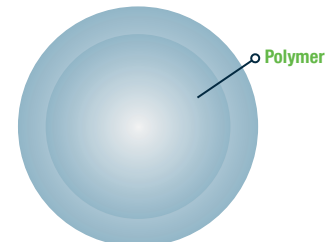

APPLICATION	CHROME & GALVANIZED FINISH	PROFORM GREEN, GRAY & BLACK EPOXY FINISH	PROFORM GREEN POLYMER FINISH	STAINLESS STEEL FINISH	ALL POLYMER FINISH
DRY STORAGE	YES	YES	YES	YES	YES
WET STORAGE	NO	YES	YES	YES	YES
COOLER STORAGE	NO	YES	YES	YES	YES
FREEZER STORAGE	NO	YES	YES	YES	YES
WARRANTY*	1 YEAR DRY	15 YEAR	15 YEAR WIRE/LIFETIME MATS	LIFETIME	LIFETIME

*Limited against rust and corrosion



MILLENNIA

Most innovative, all polymer shelving system

▶ Vented Shelf

▶ Solid Shelf

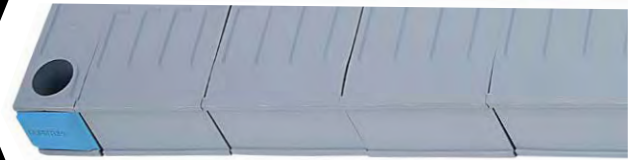

PREMIUM

Exceptional hybrid shelving

▶ Vented Polymer

▶ Solid Polymer

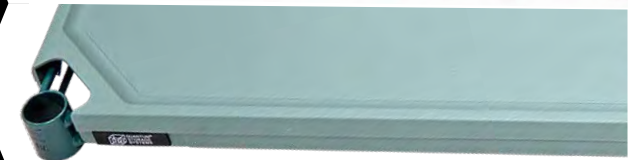

CLASSICS PLUS

Most economical, corrosion resistant shelving

▶ Green Epoxy

▶ Gray Epoxy

▶ Black Epoxy



CLASSICS

Original wire and solid storage shelving

▶ Stainless

▶ Solid Stainless

▶ Chrome

▶ Solid Galvanized





QUANTUM CLASSICS
Chrome Wire Shelving

Good



QUANTUM CLASSICS
Stainless Wire Shelving

VERY
Good



QUANTUM CLASSICS
Solid Shelving

SUPER
Good



**CHROME WIRE
SHELVING**

- 1 year limited warranty
- Up to 800 lb. load capacity per shelf
- Wire allows air to circulate and light to penetrate for increased product visibility and minimal dust buildup
- NSF Approved
- Chrome finish

WIDTHS (W): 12", 14", 18", 21", 24", 30", 36"
LENGTHS (L): 24", 30", 36", 42", 48", 54", 60", 66", 72"
HEIGHTS (H): 6", 14", 34", 36", 39", 54", 63", 74", 86", 96"

**STAINLESS STEEL
WIRE SHELVING**

- Lifetime limited warranty
- Up to 800 lb. load capacity per shelf
- Smooth, vented, open grid surface allows for air circulation and minimal dust buildup
- NSF Approved
- Antimicrobial
- 100% rust proof

WIDTHS (W): 12", 14", 18", 21", 24", 30", 36"
LENGTHS (L): 24", 30", 36", 42", 48", 54", 60", 72"
HEIGHTS (H): 6", 14", 34", 42", 54", 63", 74", 86", 96"

**SOLID SHELVING
SYSTEM**

- 1 year limited warranty on Galvanized, Lifetime limited warranty on Stainless
- Up to 600 lb. load capacity per shelf
- NSF Approved
- Stainless Steel finish is antimicrobial and 100% rust proof

WIDTHS (W): 14", 18", 21", 24"
LENGTHS (L): 24", 30", 36", 42", 48", 54", 60", 72"
HEIGHTS (H): 6", 14", 34", 38", 39", 42", 54", 63", 74", 86", 96"



QUANTUM CLASSICS PLUS Epoxy Wire Shelving

Great



CORROSION RESISTANT EPOXY COATED WIRE SHELVING

- 15 year limited warranty
- Up to 800 lb. load capacity per shelf
- Wire allows air to circulate and light to penetrate for increased product visibility and minimal dust buildup
- NSF Approved
- Antimicrobial
- Resistant against corrosion

WIDTHS (W): 12", 14", 18", 21", 24", 30", 36"
LENGTHS (L): 24", 30", 36", 42", 48", 54", 60", 66", 72"
HEIGHTS (H): 6", 14", 34", 39"(Only Black), 54", 63", 74", 86", 96"

QUANTUM PREMIUM Polymer Wire Shelving

Better



HYBRID POLYMER AND WIRE SHELVING

- 15 year limited warranty on Epoxy, Lifetime limited warranty on Polymer
- Up to 800 lb. load capacity per shelf
- Smooth, vented, open grid surface allows for air circulation and minimal dust buildup
- Easily removable and dishwasher safe shelf plates
- NSF Approved
- Antimicrobial
- Resistant against corrosion

WIDTHS (W): 14", 18", 21", 24"
LENGTHS (L): 30", 36", 42", 48", 54", 60", 72"
HEIGHTS (H): 6", 14", 34", 54", 63", 74", 86", 96"

MILLENNIA Polymer Shelving

Best



ALL POLYMER SHELVING SYSTEM

- Lifetime limited warranty
- Up to 1000 lb. load capacity per shelf
- Smooth or vented, open grid surface allows for air circulation and minimal dust buildup
- Easily removable and dishwasher safe shelf plates
- NSF Approved
- 100% rust proof
- All Polymer

WIDTHS (W): 18", 21", 24"
LENGTHS (L): 24", 30", 36", 42", 48", 54", 60", 72"
HEIGHTS (H): 14", 26", 38", 50", 62", 74", 86", 98"





Millenia Shelving



Millenia™ Shelving guarantees a premium storage option. This innovative new shelving system combines an easy to clean plus cost efficient technologies. System offers a multi-functional design and lifetime warranty against rust and corrosion. Unique dunnage add-on supports, add stability and increases weight capacity on the bottom shelf. Quantum expert shelving consultants can help you prepare a complimentary 2D or 3D layout to optimize your space.



APPLICATIONS

Food service, walk-in coolers, healthcare storage, supermarket. Suitable to be used in wet, humid, or dry environments and applications.



EASY TO ASSEMBLE AND INSTALL

Shelves come preassembled for easier installation and can be adjusted on a 1" increment. No tools required.

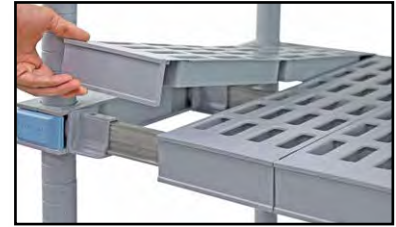

EASY TO CLEAN

Shelf plates can be easily removed for cleaning by hand or industrial dishwasher.

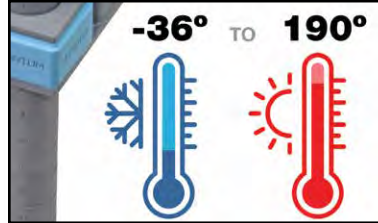

TEMPERATURE RANGE

With a wide temperature range, Millenia Shelving can be used in all extreme environments:

- Dry Storage
- Wet Storage
- Coolers
- Freezers



RUST AND CORROSION FREE

All Millenia Shelving is supported by a lifetime warranty against rust and corrosion. Its polymer composition makes it resistant to abrasive chemicals and wet environments.

PERFORMANCE FEATURES:

- Lifetime limited warranty
- Shelving unit materials:
 - Beams/Side Connectors/Adjustable Foot/Shelf Conus/Connector: Pultruded with glass fibers and thermoset resin composite
 - Shelf Plates: Polypropylene (available in vented or solid)
 - Bumper: Reinforced nylon
 - Post Cap: Polypropylene
- Up to 1,000 lb. load capacity per shelf evenly distributed and up to 2,000 lb. overall shelving unit **Dunnage stand recommended for units with 54" and longer shelves*
- No tools required for assembly
- National Sanitation Foundation (NSF) Approved
- Mobile capability available
- Shipped KD Class 92.5

WIDTHS (W): 18", 21", 24"

LENGTHS (L): 24", 30", 36", 42", 48", 54", 60", 72"

HEIGHTS (H): 14", 26", 38", 50", 62", 74", 86", 98"



CAD DESIGN

Design assistance is available for all your projects from room layouts to shelving or cart design. We'll create and develop an integrated system around your requirements. Layouts can be created to accommodate your space with the appropriate product mix.

Quantum Food Service offers the most complete package of storage products to satisfy all your requirements. Let us review your next project to maximize your storage space.

- Industry Exclusive 3D Modeling
- Blueprint & AutoCAD Compatible
- Space Utilization & Maximization
- Plan-o-grams





Millenia Shelving

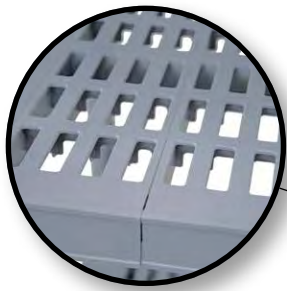

SHELF WITH VENTED SURFACE



SHELF WITH SOLID SURFACE

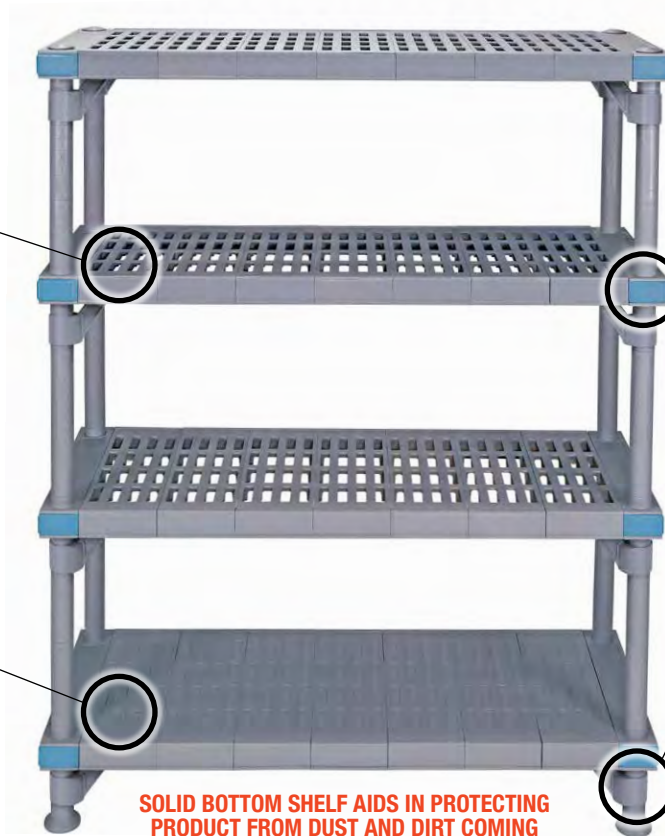

SOLID BOTTOM SHELF AIDS IN PROTECTING PRODUCT FROM DUST AND DIRT COMING FROM THE GROUND



PRIVATE LABEL CAPABILITY



UNIT CAN BE STATIONARY OR MOBILE

Maximum load capacity evenly distributed

*Extra reinforcement dunnage stand recommended for units with 54" and longer shelves

Up to 1,000 lb.
LOAD CAPACITY PER SHELF

Up to 2,000 lb.
OVERALL LOAD CAPACITY PER UNIT

TRANSFORMING THE WAY YOU WORK AND STORE

Optimized Space Utilization

By using various accessories, multiple shelving configurations become possible without compromising the maximum load capacity of the shelving system.



ADD-ON UNIT CAPABILITY (SIDE TO SIDE)



ADD-ON UNIT CAPABILITY (L-SHAPE)



ADD-ON UNIT CAPABILITY (U-SHAPE)



STORAGE

MILLENNIA SHELVING - SHELVES AND POSTS

Millenia Shelves



Each shelf includes 4 packs of split sleeves **QPSS** and 4 support gussets **QPG**.

MODEL NO.	NOMINAL DIMENSIONS W" x L"	SHIP WGT
Millenia Shelving Solid Shelves		
QP1824SS	18" x 24"	6 lbs
QP1830SS	18" x 30"	7 lbs
QP1836SS	18" x 36"	9 lbs
QP1842SS	18" x 42"	10 lbs
QP1848SS	18" x 48"	11 lbs
QP1854SS	18" x 54"	12 lbs
QP1860SS	18" x 60"	13 lbs
QP1872SS	18" x 72"	15 lbs
QP2124SS	21" x 24"	7 lbs
QP2130SS	21" x 30"	8 lbs
QP2136SS	21" x 36"	9 lbs
QP2142SS	21" x 42"	10 lbs
QP2148SS	21" x 48"	12 lbs
QP2154SS	21" x 54"	13 lbs
QP2160SS	21" x 60"	14 lbs
QP2172SS	21" x 72"	16 lbs
QP2424SS	24" x 24"	8 lbs
QP2430SS	24" x 30"	10 lbs
QP2436SS	24" x 36"	12 lbs
QP2442SS	24" x 42"	13 lbs
QP2448SS	24" x 48"	15 lbs
QP2454SS	24" x 54"	16 lbs
QP2460SS	24" x 60"	18 lbs
QP2472SS	24" x 72"	21 lbs
Millenia Shelving Vented Shelves		
QP1824VS	18" x 24"	6 lbs
QP1830VS	18" x 30"	7 lbs
QP1836VS	18" x 36"	8 lbs
QP1842VS	18" x 42"	9 lbs
QP1848VS	18" x 48"	10 lbs
QP1854VS	18" x 54"	11 lbs
QP1860VS	18" x 60"	12 lbs
QP1872VS	18" x 72"	14 lbs
QP2124VS	21" x 24"	6 lbs
QP2130VS	21" x 30"	8 lbs
QP2136VS	21" x 36"	9 lbs
QP2142VS	21" x 42"	10 lbs
QP2148VS	21" x 48"	11 lbs
QP2154VS	21" x 54"	12 lbs
QP2160VS	21" x 60"	13 lbs
QP2172VS	21" x 72"	15 lbs
QP2424VS	24" x 24"	8 lbs
QP2430VS	24" x 30"	9 lbs
QP2436VS	24" x 36"	11 lbs
QP2442VS	24" x 42"	12 lbs
QP2448VS	24" x 48"	13 lbs
QP2454VS	24" x 54"	15 lbs
QP2460VS	24" x 60"	16 lbs
QP2472VS	24" x 72"	19 lbs

Up to 1,000 lb.
LOAD CAPACITY
PER SHELF



GUSSETS **QPG**

Included with all shelves for extra support (Sold as 4-pack)



SOLID SHELF **QP1836SS**

(Plates can be removed and are dishwasher safe)



SPLIT SLEEVES **QPSS**

Included with all shelves (Sold as 4-pack)



VENTED SHELF **QP1836VS**

(Plates can be removed and are dishwasher safe)



POST CAP **QPPC**

(Sold as 4-pack)



POST **QPP14**

FLOOR ADAPTER **QPFA**

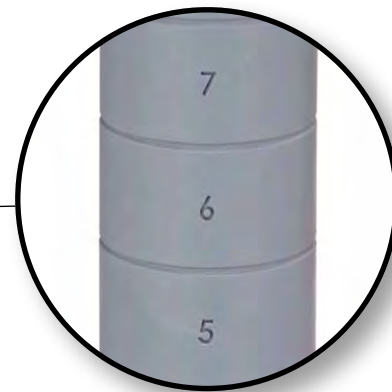

SHELF CAN BE ADJUSTED ON A 1" INCREMENTS. NO TOOLS REQUIRED

Millenia Posts



Each post includes post cap **QPPC** and floor adapter **QPFA**.

MODEL NO.	NOMINAL DIMENSIONS H"	SHIP WGT
Millenia Shelving Posts		
QPP14	14"	1 lb
QPP26	26"	1 lb
QPP38	38"	2 lbs
QPP50	50"	2 lbs
QPP62	62"	2 lbs
QPP74	74"	3 lbs
QPP86	86"	3 lbs
QPP98	98"	3 lbs



Millenia Vented Shelf Units



Vented shelves allows for storage from small to large items. Open grid surface allows for air circulation and minimal dust buildup. All vented complete shelf units consist of 4 or 5 shelves and 4 posts. Mobilizer starter kit shelving unit using optional mobile kit.

Up to 1,000 lb. LOAD CAPACITY PER SHELF

OPTIONAL MOBILE KIT QPPSC-5S

Includes four 5"x1-1/4" Polymer swivel casters, 2 with brake and four donut bumpers
Up to 800 lb. mobile load capacity (evenly distributed)



4 SHELF VENTED UNIT



5 SHELF VENTED UNIT

MODEL NO.	NOMINAL DIMENSIONS W" x L" x H"	SHIP WGT
50" Millenia 4 Shelf Vented Shelving Unit		
QP182450VS-4	18" x 24" x 50"	31 lbs
QP183050VS-4	18" x 30" x 50"	35 lbs
QP183650VS-4	18" x 36" x 50"	39 lbs
QP184250VS-4	18" x 42" x 50"	43 lbs
QP184850VS-4	18" x 48" x 50"	47 lbs
QP185450VS-4	18" x 54" x 50"	52 lbs
QP186050VS-4	18" x 60" x 50"	56 lbs
QP187250VS-4	18" x 72" x 50"	64 lbs
QP212450VS-4	21" x 24" x 50"	33 lbs
QP213050VS-4	21" x 30" x 50"	37 lbs
QP213650VS-4	21" x 36" x 50"	42 lbs
QP214250VS-4	21" x 42" x 50"	46 lbs
QP214850VS-4	21" x 48" x 50"	50 lbs
QP215450VS-4	21" x 54" x 50"	56 lbs
QP216050VS-4	21" x 60" x 50"	60 lbs
QP217250VS-4	21" x 72" x 50"	69 lbs
QP242450VS-4	24" x 24" x 50"	39 lbs
QP243050VS-4	24" x 30" x 50"	45 lbs
QP243650VS-4	24" x 36" x 50"	50 lbs
QP244250VS-4	24" x 42" x 50"	56 lbs
QP244850VS-4	24" x 48" x 50"	61 lbs
QP245450VS-4	24" x 54" x 50"	68 lbs
QP246050VS-4	24" x 60" x 50"	74 lbs
QP247250VS-4	24" x 72" x 50"	84 lbs
50" Millenia 5 Shelf Vented Shelving Unit		
QP182450VS-5	18" x 24" x 50"	37 lbs
QP183050VS-5	18" x 30" x 50"	42 lbs
QP183650VS-5	18" x 36" x 50"	47 lbs
QP184250VS-5	18" x 42" x 50"	52 lbs
QP184850VS-5	18" x 48" x 50"	57 lbs
QP185450VS-5	18" x 54" x 50"	63 lbs
QP186050VS-5	18" x 60" x 50"	68 lbs
QP187250VS-5	18" x 72" x 50"	78 lbs
QP212450VS-5	21" x 24" x 50"	40 lbs
QP213050VS-5	21" x 30" x 50"	45 lbs
QP213650VS-5	21" x 36" x 50"	50 lbs
QP214250VS-5	21" x 42" x 50"	56 lbs
QP214850VS-5	21" x 48" x 50"	61 lbs
QP215450VS-5	21" x 54" x 50"	68 lbs
QP216050VS-5	21" x 60" x 50"	73 lbs
QP217250VS-5	21" x 72" x 50"	84 lbs
QP242450VS-5	24" x 24" x 50"	48 lbs
QP243050VS-5	24" x 30" x 50"	54 lbs
QP243650VS-5	24" x 36" x 50"	61 lbs
QP244250VS-5	24" x 42" x 50"	68 lbs
QP244850VS-5	24" x 48" x 50"	75 lbs
QP245450VS-5	24" x 54" x 50"	83 lbs
QP246050VS-5	24" x 60" x 50"	90 lbs
QP247250VS-5	24" x 72" x 50"	103 lbs

MODEL NO.	NOMINAL DIMENSIONS W" x L" x H"	SHIP WGT
62" Millenia 4 Shelf Vented Shelving Unit		
QP182462VS-4	18" x 24" x 62"	33 lbs
QP183062VS-4	18" x 30" x 62"	37 lbs
QP183662VS-4	18" x 36" x 62"	41 lbs
QP184262VS-4	18" x 42" x 62"	45 lbs
QP184862VS-4	18" x 48" x 62"	49 lbs
QP185462VS-4	18" x 54" x 62"	54 lbs
QP186062VS-4	18" x 60" x 62"	58 lbs
QP187262VS-4	18" x 72" x 62"	66 lbs
QP212462VS-4	21" x 24" x 62"	35 lbs
QP213062VS-4	21" x 30" x 62"	39 lbs
QP213662VS-4	21" x 36" x 62"	43 lbs
QP214262VS-4	21" x 42" x 62"	48 lbs
QP214862VS-4	21" x 48" x 62"	52 lbs
QP215462VS-4	21" x 54" x 62"	58 lbs
QP216062VS-4	21" x 60" x 62"	62 lbs
QP217262VS-4	21" x 72" x 62"	71 lbs
QP242462VS-4	24" x 24" x 62"	41 lbs
QP243062VS-4	24" x 30" x 62"	47 lbs
QP243662VS-4	24" x 36" x 62"	52 lbs
QP244262VS-4	24" x 42" x 62"	57 lbs
QP244862VS-4	24" x 48" x 62"	63 lbs
QP245462VS-4	24" x 54" x 62"	70 lbs
QP246062VS-4	24" x 60" x 62"	75 lbs
QP247262VS-4	24" x 72" x 62"	86 lbs
62" Millenia 5 Shelf Vented Shelving Unit		
QP182462VS-5	18" x 24" x 62"	39 lbs
QP183062VS-5	18" x 30" x 62"	44 lbs
QP183662VS-5	18" x 36" x 62"	49 lbs
QP184262VS-5	18" x 42" x 62"	54 lbs
QP184862VS-5	18" x 48" x 62"	59 lbs
QP185462VS-5	18" x 54" x 62"	65 lbs
QP186062VS-5	18" x 60" x 62"	70 lbs
QP187262VS-5	18" x 72" x 62"	80 lbs
QP212462VS-5	21" x 24" x 62"	41 lbs
QP213062VS-5	21" x 30" x 62"	47 lbs
QP213662VS-5	21" x 36" x 62"	52 lbs
QP214262VS-5	21" x 42" x 62"	57 lbs
QP214862VS-5	21" x 48" x 62"	63 lbs
QP215462VS-5	21" x 54" x 62"	70 lbs
QP216062VS-5	21" x 60" x 62"	75 lbs
QP217262VS-5	21" x 72" x 62"	86 lbs
QP242462VS-5	24" x 24" x 62"	49 lbs
QP243062VS-5	24" x 30" x 62"	56 lbs
QP243662VS-5	24" x 36" x 62"	63 lbs
QP244262VS-5	24" x 42" x 62"	70 lbs
QP244862VS-5	24" x 48" x 62"	76 lbs
QP245462VS-5	24" x 54" x 62"	85 lbs
QP246062VS-5	24" x 60" x 62"	91 lbs
QP247262VS-5	24" x 72" x 62"	105 lbs

MODEL NO.	NOMINAL DIMENSIONS W" x L" x H"	SHIP WGT
74" Millenia 4 Shelf Vented Shelving Unit		
QP182474VS-4*	18" x 24" x 74"	35 lbs
QP183074VS-4*	18" x 30" x 74"	39 lbs
QP183674VS-4*	18" x 36" x 74"	43 lbs
QP184274VS-4*	18" x 42" x 74"	46 lbs
QP184874VS-4*	18" x 48" x 74"	50 lbs
QP185474VS-4	18" x 54" x 74"	56 lbs
QP186074VS-4	18" x 60" x 74"	60 lbs
QP187274VS-4	18" x 72" x 74"	67 lbs
QP212474VS-4*	21" x 24" x 74"	36 lbs
QP213074VS-4*	21" x 30" x 74"	41 lbs
QP213674VS-4*	21" x 36" x 74"	45 lbs
QP214274VS-4*	21" x 42" x 74"	49 lbs
QP214874VS-4*	21" x 48" x 74"	54 lbs
QP215474VS-4	21" x 54" x 74"	59 lbs
QP216074VS-4	21" x 60" x 74"	64 lbs
QP217274VS-4	21" x 72" x 74"	72 lbs
QP242474VS-4*	24" x 24" x 74"	43 lbs
QP243074VS-4*	24" x 30" x 74"	48 lbs
QP243674VS-4*	24" x 36" x 74"	54 lbs
QP244274VS-4*	24" x 42" x 74"	59 lbs
QP244874VS-4*	24" x 48" x 74"	65 lbs
QP245474VS-4	24" x 54" x 74"	72 lbs
QP246074VS-4	24" x 60" x 74"	77 lbs
QP247274VS-4	24" x 72" x 74"	88 lbs
74" Millenia 5 Shelf Vented Shelving Unit		
QP182474VS-5	18" x 24" x 74"	41 lbs
QP183074VS-5	18" x 30" x 74"	46 lbs
QP183674VS-5	18" x 36" x 74"	51 lbs
QP184274VS-5	18" x 42" x 74"	55 lbs
QP184874VS-5	18" x 48" x 74"	60 lbs
QP185474VS-5	18" x 54" x 74"	67 lbs
QP186074VS-5	18" x 60" x 74"	72 lbs
QP187274VS-5	18" x 72" x 74"	81 lbs
QP212474VS-5	21" x 24" x 74"	43 lbs
QP213074VS-5	21" x 30" x 74"	48 lbs
QP213674VS-5	21" x 36" x 74"	54 lbs
QP214274VS-5	21" x 42" x 74"	59 lbs
QP214874VS-5	21" x 48" x 74"	64 lbs
QP215474VS-5	21" x 54" x 74"	71 lbs
QP216074VS-5	21" x 60" x 74"	77 lbs
QP217274VS-5	21" x 72" x 74"	87 lbs
QP242474VS-5	24" x 24" x 74"	51 lbs
QP243074VS-5	24" x 30" x 74"	58 lbs
QP243674VS-5	24" x 36" x 74"	64 lbs
QP244274VS-5	24" x 42" x 74"	71 lbs
QP244874VS-5	24" x 48" x 74"	78 lbs
QP245474VS-5	24" x 54" x 74"	86 lbs
QP246074VS-5	24" x 60" x 74"	93 lbs
QP247274VS-5	24" x 72" x 74"	107 lbs

MODEL NO.	NOMINAL DIMENSIONS W" x L" x H"	SHIP WGT
86" Millenia 4 Shelf Vented Shelving Unit		
QP182486VS-4	18" x 24" x 86"	36 lbs
QP183086VS-4	18" x 30" x 86"	40 lbs
QP183686VS-4	18" x 36" x 86"	44 lbs
QP184286VS-4	18" x 42" x 86"	48 lbs
QP184886VS-4	18" x 48" x 86"	52 lbs
QP185486VS-4	18" x 54" x 86"	57 lbs
QP186086VS-4	18" x 60" x 86"	61 lbs
QP187286VS-4	18" x 72" x 86"	69 lbs
QP212486VS-4	21" x 24" x 86"	38 lbs
QP213086VS-4	21" x 30" x 86"	42 lbs
QP213686VS-4	21" x 36" x 86"	47 lbs
QP214286VS-4	21" x 42" x 86"	51 lbs
QP214886VS-4	21" x 48" x 86"	55 lbs
QP215486VS-4	21" x 54" x 86"	61 lbs
QP216086VS-4	21" x 60" x 86"	65 lbs
QP217286VS-4	21" x 72" x 86"	74 lbs
QP242486VS-4	24" x 24" x 86"	44 lbs
QP243086VS-4	24" x 30" x 86"	50 lbs
QP243686VS-4	24" x 36" x 86"	55 lbs
QP244286VS-4	24" x 42" x 86"	61 lbs
QP244886VS-4	24" x 48" x 86"	66 lbs
QP245486VS-4	24" x 54" x 86"	73 lbs
QP246086VS-4	24" x 60" x 86"	79 lbs
QP247286VS-4	24" x 72" x 86"	89 lbs
86" Millenia 5 Shelf Vented Shelving Unit		
QP182486VS-5	18" x 24" x 86"	42 lbs
QP183086VS-5	18" x 30" x 86"	47 lbs
QP183686VS-5	18" x 36" x 86"	52 lbs
QP184286VS-5	18" x 42" x 86"	57 lbs
QP184886VS-5	18" x 48" x 86"	62 lbs
QP185486VS-5	18" x 54" x 86"	68 lbs
QP186086VS-5	18" x 60" x 86"	73 lbs
QP187286VS-5	18" x 72" x 86"	83 lbs
QP212486VS-5	21" x 24" x 86"	45 lbs
QP213086VS-5	21" x 30" x 86"	50 lbs
QP213686VS-5	21" x 36" x 86"	55 lbs
QP214286VS-5	21" x 42" x 86"	61 lbs
QP214886VS-5	21" x 48" x 86"	66 lbs
QP215486VS-5	21" x 54" x 86"	73 lbs
QP216086VS-5	21" x 60" x 86"	78 lbs
QP217286VS-5	21" x 72" x 86"	89 lbs
QP242486VS-5	24" x 24" x 86"	53 lbs
QP243086VS-5	24" x 30" x 86"	59 lbs
QP243686VS-5	24" x 36" x 86"	66 lbs
QP244286VS-5	24" x 42" x 86"	73 lbs
QP244886VS-5	24" x 48" x 86"	80 lbs
QP245486VS-5	24" x 54" x 86"	88 lbs
QP246086VS-5	24" x 60" x 86"	95 lbs
QP247286VS-5	24" x 72" x 86"	108 lbs

*PACKAGED AS SINGLE BOX SHELVING UNITS Each box includes 4 posts, 4 open grid shelves with removable shelf plates, 1 package of needed split sleeves, post caps, post levelers, gussets and wall brackets



STORAGE

MILLENNIA SHELVING - SOLID SHELF UNITS

Millenia Solid Shelf Units



Solid bottom shelf aids in protecting product from dust and dirt coming from the ground. All solid complete shelf units consist of 4 or 5 shelves and 4 posts. Mobilize starter kit shelving unit using optional mobile kit.

Up to 1,000 lb.
LOAD CAPACITY PER SHELF

OPTIONAL MOBILE KIT QPPSC-5S

Includes four 5"x1-1/4" Polymer swivel casters, 2 with brake and four donut bumpers
Up to 800 lb. mobile load capacity (evenly distributed)



4 SHELF SOLID UNIT



5 SHELF SOLID UNIT

MODEL NO.	NOMINAL DIMENSIONS W" x L" x H"	SHIP WGT
50" Millenia 4 Shelf Solid Shelving Unit		
QP182450SS-4	18" x 24" x 50"	33 lbs
QP183050SS-4	18" x 30" x 50"	37 lbs
QP183650SS-4	18" x 36" x 50"	41 lbs
QP184250SS-4	18" x 42" x 50"	46 lbs
QP184850SS-4	18" x 48" x 50"	50 lbs
QP185450SS-4	18" x 54" x 50"	56 lbs
QP186050SS-4	18" x 60" x 50"	60 lbs
QP187250SS-4	18" x 72" x 50"	69 lbs
QP212450SS-4	21" x 24" x 50"	35 lbs
QP213050SS-4	21" x 30" x 50"	39 lbs
QP213650SS-4	21" x 36" x 50"	44 lbs
QP214250SS-4	21" x 42" x 50"	49 lbs
QP214850SS-4	21" x 48" x 50"	54 lbs
QP215450SS-4	21" x 54" x 50"	60 lbs
QP216050SS-4	21" x 60" x 50"	65 lbs
QP217250SS-4	21" x 72" x 50"	75 lbs
QP242450SS-4	24" x 24" x 50"	41 lbs
QP243050SS-4	24" x 30" x 50"	47 lbs
QP243650SS-4	24" x 36" x 50"	53 lbs
QP244250SS-4	24" x 42" x 50"	59 lbs
QP244850SS-4	24" x 48" x 50"	65 lbs
QP245450SS-4	24" x 54" x 50"	73 lbs
QP246050SS-4	24" x 60" x 50"	79 lbs
QP247250SS-4	24" x 72" x 50"	91 lbs

MODEL NO.	NOMINAL DIMENSIONS W" x L" x H"	SHIP WGT
50" Millenia 5 Shelf Solid Shelving Unit		
QP182450SS-5	18" x 24" x 50"	39 lbs
QP183050SS-5	18" x 30" x 50"	45 lbs
QP183650SS-5	18" x 36" x 50"	50 lbs
QP184250SS-5	18" x 42" x 50"	55 lbs
QP184850SS-5	18" x 48" x 50"	61 lbs
QP185450SS-5	18" x 54" x 50"	68 lbs
QP186050SS-5	18" x 60" x 50"	73 lbs
QP187250SS-5	18" x 72" x 50"	84 lbs
QP212450SS-5	21" x 24" x 50"	42 lbs
QP213050SS-5	21" x 30" x 50"	48 lbs
QP213650SS-5	21" x 36" x 50"	54 lbs
QP214250SS-5	21" x 42" x 50"	60 lbs
QP214850SS-5	21" x 48" x 50"	66 lbs
QP215450SS-5	21" x 54" x 50"	73 lbs
QP216050SS-5	21" x 60" x 50"	79 lbs
QP217250SS-5	21" x 72" x 50"	91 lbs
QP242450SS-5	24" x 24" x 50"	50 lbs
QP243050SS-5	24" x 30" x 50"	57 lbs
QP243650SS-5	24" x 36" x 50"	65 lbs
QP244250SS-5	24" x 42" x 50"	72 lbs
QP244850SS-5	24" x 48" x 50"	80 lbs
QP245450SS-5	24" x 54" x 50"	89 lbs
QP246050SS-5	24" x 60" x 50"	96 lbs
QP247250SS-5	24" x 72" x 50"	112 lbs

MODEL NO.	NOMINAL DIMENSIONS W" x L" x H"	SHIP WGT
62" Millenia 4 Shelf Solid Shelving Unit		
QP182462SS-4	18" x 24" x 62"	34 lbs
QP183062SS-4	18" x 30" x 62"	39 lbs
QP183662SS-4	18" x 36" x 62"	43 lbs
QP184262SS-4	18" x 42" x 62"	47 lbs
QP184862SS-4	18" x 48" x 62"	52 lbs
QP185462SS-4	18" x 54" x 62"	58 lbs
QP186062SS-4	18" x 60" x 62"	62 lbs
QP187262SS-4	18" x 72" x 62"	71 lbs
QP212462SS-4	21" x 24" x 62"	36 lbs
QP213062SS-4	21" x 30" x 62"	41 lbs
QP213662SS-4	21" x 36" x 62"	46 lbs
QP214262SS-4	21" x 42" x 62"	51 lbs
QP214862SS-4	21" x 48" x 62"	56 lbs
QP215462SS-4	21" x 54" x 62"	62 lbs
QP216062SS-4	21" x 60" x 62"	67 lbs
QP217262SS-4	21" x 72" x 62"	76 lbs
QP242462SS-4	24" x 24" x 62"	43 lbs
QP243062SS-4	24" x 30" x 62"	49 lbs
QP243662SS-4	24" x 36" x 62"	55 lbs
QP244262SS-4	24" x 42" x 62"	61 lbs
QP244862SS-4	24" x 48" x 62"	67 lbs
QP245462SS-4	24" x 54" x 62"	75 lbs
QP246062SS-4	24" x 60" x 62"	81 lbs
QP247262SS-4	24" x 72" x 62"	93 lbs

MODEL NO.	NOMINAL DIMENSIONS W" x L" x H"	SHIP WGT
62" Millenia 5 Shelf Solid Shelving Unit		
QP182462SS-5	18" x 24" x 62"	41 lbs
QP183062SS-5	18" x 30" x 62"	46 lbs
QP183662SS-5	18" x 36" x 62"	52 lbs
QP184262SS-5	18" x 42" x 62"	57 lbs
QP184862SS-5	18" x 48" x 62"	62 lbs
QP185462SS-5	18" x 54" x 62"	69 lbs
QP186062SS-5	18" x 60" x 62"	75 lbs
QP187262SS-5	18" x 72" x 62"	86 lbs
QP212462SS-5	21" x 24" x 62"	43 lbs
QP213062SS-5	21" x 30" x 62"	49 lbs
QP213662SS-5	21" x 36" x 62"	55 lbs
QP214262SS-5	21" x 42" x 62"	61 lbs
QP214862SS-5	21" x 48" x 62"	67 lbs
QP215462SS-5	21" x 54" x 62"	75 lbs
QP216062SS-5	21" x 60" x 62"	81 lbs
QP217262SS-5	21" x 72" x 62"	93 lbs
QP242462SS-5	24" x 24" x 62"	51 lbs
QP243062SS-5	24" x 30" x 62"	59 lbs
QP243662SS-5	24" x 36" x 62"	66 lbs
QP244262SS-5	24" x 42" x 62"	74 lbs
QP244862SS-5	24" x 48" x 62"	82 lbs
QP245462SS-5	24" x 54" x 62"	91 lbs
QP246062SS-5	24" x 60" x 62"	98 lbs
QP247262SS-5	24" x 72" x 62"	113 lbs

MODEL NO.	NOMINAL DIMENSIONS W" x L" x H"	SHIP WGT
74" Millenia 4 Shelf Solid Shelving Unit		
QP182474SS-4	18" x 24" x 74"	36 lbs
QP183074SS-4	18" x 30" x 74"	40 lbs
QP183674SS-4	18" x 36" x 74"	45 lbs
QP184274SS-4	18" x 42" x 74"	49 lbs
QP184874SS-4	18" x 48" x 74"	53 lbs
QP185474SS-4	18" x 54" x 74"	59 lbs
QP186074SS-4	18" x 60" x 74"	64 lbs
QP187274SS-4	18" x 72" x 74"	72 lbs
QP212474SS-4	21" x 24" x 74"	38 lbs
QP213074SS-4	21" x 30" x 74"	43 lbs
QP213674SS-4	21" x 36" x 74"	48 lbs
QP214274SS-4	21" x 42" x 74"	52 lbs
QP214874SS-4	21" x 48" x 74"	57 lbs
QP215474SS-4	21" x 54" x 74"	64 lbs
QP216074SS-4	21" x 60" x 74"	68 lbs
QP217274SS-4	21" x 72" x 74"	78 lbs
QP242474SS-4	24" x 24" x 74"	45 lbs
QP243074SS-4	24" x 30" x 74"	51 lbs
QP243674SS-4	24" x 36" x 74"	57 lbs
QP244274SS-4	24" x 42" x 74"	63 lbs
QP244874SS-4	24" x 48" x 74"	69 lbs
QP245474SS-4	24" x 54" x 74"	76 lbs
QP246074SS-4	24" x 60" x 74"	82 lbs
QP247274SS-4	24" x 72" x 74"	94 lbs

MODEL NO.	NOMINAL DIMENSIONS W" x L" x H"	SHIP WGT
74" Millenia 5 Shelf Solid Shelving Unit		
QP182474SS-5	18" x 24" x 74"	42 lbs
QP183074SS-5	18" x 30" x 74"	48 lbs
QP183674SS-5	18" x 36" x 74"	53 lbs
QP184274SS-5	18" x 42" x 74"	59 lbs
QP184874SS-5	18" x 48" x 74"	64 lbs
QP185474SS-5	18" x 54" x 74"	71 lbs
QP186074SS-5	18" x 60" x 74"	76 lbs
QP187274SS-5	18" x 72" x 74"	87 lbs
QP212474SS-5	21" x 24" x 74"	45 lbs
QP213074SS-5	21" x 30" x 74"	51 lbs
QP213674SS-5	21" x 36" x 74"	57 lbs
QP214274SS-5	21" x 42" x 74"	63 lbs
QP214874SS-5	21" x 48" x 74"	69 lbs
QP215474SS-5	21" x 54" x 74"	76 lbs
QP216074SS-5	21" x 60" x 74"	82 lbs
QP217274SS-5	21" x 72" x 74"	94 lbs
QP242474SS-5	24" x 24" x 74"	53 lbs
QP243074SS-5	24" x 30" x 74"	61 lbs
QP243674SS-5	24" x 36" x 74"	68 lbs
QP244274SS-5	24" x 42" x 74"	76 lbs
QP244874SS-5	24" x 48" x 74"	83 lbs
QP245474SS-5	24" x 54" x 74"	92 lbs
QP246074SS-5	24" x 60" x 74"	100 lbs
QP247274SS-5	24" x 72" x 74"	115 lbs

MODEL NO.	NOMINAL DIMENSIONS W" x L" x H"	SHIP WGT
86" Millenia 4 Shelf Solid Shelving Unit		
QP182486SS-4	18" x 24" x 86"	38 lbs
QP183086SS-4	18" x 30" x 86"	42 lbs
QP183686SS-4	18" x 36" x 86"	46 lbs
QP184286SS-4	18" x 42" x 86"	51 lbs
QP184886SS-4	18" x 48" x 86"	55 lbs
QP185486SS-4	18" x 54" x 86"	61 lbs
QP186086SS-4	18" x 60" x 86"	65 lbs
QP187286SS-4	18" x 72" x 86"	74 lbs
QP212486SS-4	21" x 24" x 86"	40 lbs
QP213086SS-4	21" x 30" x 86"	44 lbs
QP213686SS-4	21" x 36" x 86"	49 lbs
QP214286SS-4	21" x 42" x 86"	54 lbs
QP214886SS-4	21" x 48" x 86"	59 lbs
QP215486SS-4	21" x 54" x 86"	65 lbs
QP216086SS-4	21" x 60" x 86"	70 lbs
QP217286SS-4	21" x 72" x 86"	80 lbs
QP242486SS-4	24" x 24" x 86"	46 lbs
QP243086SS-4	24" x 30" x 86"	52 lbs
QP243686SS-4	24" x 36" x 86"	58 lbs
QP244286SS-4	24" x 42" x 86"	64 lbs
QP244886SS-4	24" x 48" x 86"	70 lbs
QP245486SS-4	24" x 54" x 86"	78 lbs
QP246086SS-4	24" x 60" x 86"	84 lbs
QP247286SS-4	24" x 72" x 86"	96 lbs

MODEL NO.	NOMINAL DIMENSIONS W" x L" x H"	SHIP WGT
86" Millenia 5 Shelf Solid Shelving Unit		
QP182486SS-5	18" x 24" x 86"	44 lbs
QP183086SS-5	18" x 30" x 86"	49 lbs
QP183686SS-5	18" x 36" x 86"	55 lbs
QP184286SS-5	18" x 42" x 86"	60 lbs
QP184886SS-5	18" x 48" x 86"	66 lbs
QP185486SS-5	18" x 54" x 86"	73 lbs
QP186086SS-5	18" x 60" x 86"	78 lbs
QP187286SS-5	18" x 72" x 86"	89 lbs
QP212486SS-5	21" x 24" x 86"	47 lbs
QP213086SS-5	21" x 30" x 86"	53 lbs
QP213686SS-5	21" x 36" x 86"	58 lbs
QP214286SS-5	21" x 42" x 86"	64 lbs
QP214886SS-5	21" x 48" x 86"	70 lbs
QP215486SS-5	21" x 54" x 86"	78 lbs
QP216086SS-5	21" x 60" x 86"	84 lbs
QP217286SS-5	21" x 72" x 86"	96 lbs
QP242486SS-5	24" x 24" x 86"	55 lbs
QP243086SS-5	24" x 30" x 86"	62 lbs
QP243686SS-5	24" x 36" x 86"	70 lbs
QP244286SS-5	24" x 42" x 86"	77 lbs
QP244886SS-5	24" x 48" x 86"	85 lbs
QP245486SS-5	24" x 54" x 86"	94 lbs
QP246086SS-5	24" x 60" x 86"	101 lbs
QP247286SS-5	24" x 72" x 86"	116 lbs



Millenia Mixed Shelf Units



Mixed units have all vented shelves and solid bottom shelf. All complete mix shelf units consist of 3 or 4 vented shelves with a solid bottom shelf and 4 posts. Mobilize starter kit shelving unit using optional mobile kit.

Up to 1,000 lb.
LOAD CAPACITY PER SHELF

OPTIONAL MOBILE KIT
QPPSC-5S

Includes four 5"x1-1/4" Polymer swivel casters, 2 with brake and four donut bumpers
Up to 800 lb. mobile load capacity (evenly distributed)



4 SHELF MIXED UNIT



5 SHELF MIXED UNIT

MODEL NO.	NOMINAL DIMENSIONS W" x L" x H"	SHIP WGT
62" Millenia 3 Vented 1 Solid Shelving Unit		
QP182462V3S1	18" x 24" x 62"	33 lbs
QP183062V3S1	18" x 30" x 62"	37 lbs
QP183662V3S1	18" x 36" x 62"	41 lbs
QP184262V3S1	18" x 42" x 62"	45 lbs
QP184862V3S1	18" x 48" x 62"	49 lbs
QP185462V3S1	18" x 54" x 62"	55 lbs
QP186062V3S1	18" x 60" x 62"	59 lbs
QP187262V3S1	18" x 72" x 62"	67 lbs
QP212462V3S1	21" x 24" x 62"	35 lbs
QP213062V3S1	21" x 30" x 62"	40 lbs
QP213662V3S1	21" x 36" x 62"	44 lbs
QP214262V3S1	21" x 42" x 62"	48 lbs
QP214862V3S1	21" x 48" x 62"	53 lbs
QP215462V3S1	21" x 54" x 62"	59 lbs
QP216062V3S1	21" x 60" x 62"	63 lbs
QP217262V3S1	21" x 72" x 62"	72 lbs
QP242462V3S1	24" x 24" x 62"	42 lbs
QP243062V3S1	24" x 30" x 62"	47 lbs
QP243662V3S1	24" x 36" x 62"	53 lbs
QP244262V3S1	24" x 42" x 62"	58 lbs
QP244862V3S1	24" x 48" x 62"	64 lbs
QP245462V3S1	24" x 54" x 62"	71 lbs
QP246062V3S1	24" x 60" x 62"	77 lbs
QP247262V3S1	24" x 72" x 62"	88 lbs
62" Millenia 4 Vented 1 Solid Shelving Unit		
QP182462V4S1	18" x 24" x 62"	39 lbs
QP183062V4S1	18" x 30" x 62"	44 lbs
QP183662V4S1	18" x 36" x 62"	49 lbs
QP184262V4S1	18" x 42" x 62"	54 lbs
QP184862V4S1	18" x 48" x 62"	59 lbs
QP185462V4S1	18" x 54" x 62"	66 lbs
QP186062V4S1	18" x 60" x 62"	71 lbs
QP187262V4S1	18" x 72" x 62"	81 lbs
QP212462V4S1	21" x 24" x 62"	42 lbs
QP213062V4S1	21" x 30" x 62"	47 lbs
QP213662V4S1	21" x 36" x 62"	53 lbs
QP214262V4S1	21" x 42" x 62"	58 lbs
QP214862V4S1	21" x 48" x 62"	64 lbs
QP215462V4S1	21" x 54" x 62"	71 lbs
QP216062V4S1	21" x 60" x 62"	76 lbs
QP217262V4S1	21" x 72" x 62"	87 lbs
QP242462V4S1	24" x 24" x 62"	50 lbs
QP243062V4S1	24" x 30" x 62"	57 lbs
QP243662V4S1	24" x 36" x 62"	64 lbs
QP244262V4S1	24" x 42" x 62"	70 lbs
QP244862V4S1	24" x 48" x 62"	77 lbs
QP245462V4S1	24" x 54" x 62"	86 lbs
QP246062V4S1	24" x 60" x 62"	93 lbs
QP247262V4S1	24" x 72" x 62"	107 lbs

MODEL NO.	NOMINAL DIMENSIONS W" x L" x H"	SHIP WGT
74" Millenia 3 Vented 1 Solid Shelving Unit		
QP182474V3S1	18" x 24" x 74"	35 lbs
QP183074V3S1	18" x 30" x 74"	39 lbs
QP183674V3S1	18" x 36" x 74"	43 lbs
QP184274V3S1	18" x 42" x 74"	47 lbs
QP184874V3S1	18" x 48" x 74"	51 lbs
QP185474V3S1	18" x 54" x 74"	57 lbs
QP186074V3S1	18" x 60" x 74"	61 lbs
QP187274V3S1	18" x 72" x 74"	69 lbs
QP212474V3S1	21" x 24" x 74"	37 lbs
QP213074V3S1	21" x 30" x 74"	41 lbs
QP213674V3S1	21" x 36" x 74"	46 lbs
QP214274V3S1	21" x 42" x 74"	50 lbs
QP214874V3S1	21" x 48" x 74"	54 lbs
QP215474V3S1	21" x 54" x 74"	60 lbs
QP216074V3S1	21" x 60" x 74"	65 lbs
QP217274V3S1	21" x 72" x 74"	74 lbs
QP242474V3S1	24" x 24" x 74"	43 lbs
QP243074V3S1	24" x 30" x 74"	49 lbs
QP243674V3S1	24" x 36" x 74"	54 lbs
QP244274V3S1	24" x 42" x 74"	60 lbs
QP244874V3S1	24" x 48" x 74"	66 lbs
QP245474V3S1	24" x 54" x 74"	73 lbs
QP246074V3S1	24" x 60" x 74"	78 lbs
QP247274V3S1	24" x 72" x 74"	89 lbs
74" Millenia 4 Vented 1 Solid Shelving Unit		
QP182474V4S1	18" x 24" x 74"	41 lbs
QP183074V4S1	18" x 30" x 74"	46 lbs
QP183674V4S1	18" x 36" x 74"	51 lbs
QP184274V4S1	18" x 42" x 74"	56 lbs
QP184874V4S1	18" x 48" x 74"	61 lbs
QP185474V4S1	18" x 54" x 74"	68 lbs
QP186074V4S1	18" x 60" x 74"	73 lbs
QP187274V4S1	18" x 72" x 74"	83 lbs
QP212474V4S1	21" x 24" x 74"	43 lbs
QP213074V4S1	21" x 30" x 74"	49 lbs
QP213674V4S1	21" x 36" x 74"	54 lbs
QP214274V4S1	21" x 42" x 74"	60 lbs
QP214874V4S1	21" x 48" x 74"	65 lbs
QP215474V4S1	21" x 54" x 74"	72 lbs
QP216074V4S1	21" x 60" x 74"	78 lbs
QP217274V4S1	21" x 72" x 74"	89 lbs
QP242474V4S1	24" x 24" x 74"	51 lbs
QP243074V4S1	24" x 30" x 74"	58 lbs
QP243674V4S1	24" x 36" x 74"	65 lbs
QP244274V4S1	24" x 42" x 74"	72 lbs
QP244874V4S1	24" x 48" x 74"	79 lbs
QP245474V4S1	24" x 54" x 74"	88 lbs
QP246074V4S1	24" x 60" x 74"	94 lbs
QP247274V4S1	24" x 72" x 74"	108 lbs

MODEL NO.	NOMINAL DIMENSIONS W" x L" x H"	SHIP WGT
86" Millenia 3 Vented 1 Solid Shelving Unit		
QP182486V3S1	18" x 24" x 86"	38 lbs
QP183086V3S1	18" x 30" x 86"	42 lbs
QP183686V3S1	18" x 36" x 86"	46 lbs
QP184286V3S1	18" x 42" x 86"	51 lbs
QP184886V3S1	18" x 48" x 86"	55 lbs
QP185486V3S1	18" x 54" x 86"	61 lbs
QP186086V3S1	18" x 60" x 86"	65 lbs
QP187286V3S1	18" x 72" x 86"	74 lbs
QP212486V3S1	21" x 24" x 86"	40 lbs
QP213086V3S1	21" x 30" x 86"	44 lbs
QP213686V3S1	21" x 36" x 86"	49 lbs
QP214286V3S1	21" x 42" x 86"	54 lbs
QP214886V3S1	21" x 48" x 86"	59 lbs
QP215486V3S1	21" x 54" x 86"	65 lbs
QP216086V3S1	21" x 60" x 86"	70 lbs
QP217286V3S1	21" x 72" x 86"	80 lbs
QP242486V3S1	24" x 24" x 86"	46 lbs
QP243086V3S1	24" x 30" x 86"	52 lbs
QP243686V3S1	24" x 36" x 86"	58 lbs
QP244286V3S1	24" x 42" x 86"	64 lbs
QP244886V3S1	24" x 48" x 86"	70 lbs
QP245486V3S1	24" x 54" x 86"	78 lbs
QP246086V3S1	24" x 60" x 86"	84 lbs
QP247286V3S1	24" x 72" x 86"	96 lbs
86" Millenia 4 Vented 1 Solid Shelving Unit		
QP182486V4S1	18" x 24" x 86"	43 lbs
QP183086V4S1	18" x 30" x 86"	48 lbs
QP183686V4S1	18" x 36" x 86"	53 lbs
QP184286V4S1	18" x 42" x 86"	58 lbs
QP184886V4S1	18" x 48" x 86"	63 lbs
QP185486V4S1	18" x 54" x 86"	69 lbs
QP186086V4S1	18" x 60" x 86"	74 lbs
QP187286V4S1	18" x 72" x 86"	84 lbs
QP212486V4S1	21" x 24" x 86"	45 lbs
QP213086V4S1	21" x 30" x 86"	50 lbs
QP213686V4S1	21" x 36" x 86"	56 lbs
QP214286V4S1	21" x 42" x 86"	61 lbs
QP214886V4S1	21" x 48" x 86"	67 lbs
QP215486V4S1	21" x 54" x 86"	74 lbs
QP216086V4S1	21" x 60" x 86"	79 lbs
QP217286V4S1	21" x 72" x 86"	90 lbs
QP242486V4S1	24" x 24" x 86"	53 lbs
QP243086V4S1	24" x 30" x 86"	60 lbs
QP243686V4S1	24" x 36" x 86"	67 lbs
QP244286V4S1	24" x 42" x 86"	74 lbs
QP244886V4S1	24" x 48" x 86"	81 lbs
QP245486V4S1	24" x 54" x 86"	89 lbs
QP246086V4S1	24" x 60" x 86"	96 lbs
QP247286V4S1	24" x 72" x 86"	110 lbs



Accessories

PRODUCT ORGANIZATION

MODEL NO.	DIMENSIONS W" x H"	SHIP WGT
Millenia Dividers		
QPDIV18	18" x 7-7/8"	1 lb
QPDIV21	21" x 7-7/8"	1 lb
QPDIV24	24" x 7-7/8"	1 lb
Millenia Ledges		
QPL18	18" x 2-1/4"	1 lb
QPL21	21" x 2-1/4"	1 lb
QPL24	24" x 2-1/4"	1 lb
QPL30	30" x 2-1/4"	1 lb
QPL36	36" x 2-1/4"	1 lb
QPL42	42" x 2-1/4"	1 lb
QPL48	48" x 2-1/4"	1 lb
QPL54	54" x 2-1/4"	2 lbs
QPL60	60" x 2-1/4"	2 lbs
QPL72	72" x 2-1/4"	2 lbs



DIVIDERS
QPDIV
7-7/8" Height

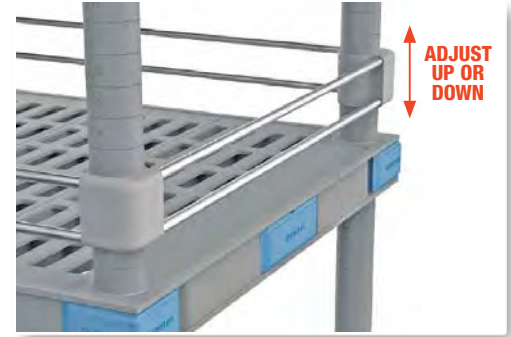

**ADJUSTABLE HEIGHT
SIDE AND BACK LEDGE**
QPL
2-1/4" Height

LABEL HOLDERS

MODEL NO.	DIMENSIONS W"	SHIP WGT
Millenia Label Holders		
QPLH5C	5-1/2" Clear Label Holder	1 lb
QPLH17C	17-1/2" Clear Label Holder Fits 24" Shelf	1 lb
QPLH23C	23-1/2" Clear Label Holder Fits 30" Shelf	1 lb
QPLH29C	29-1/2" Clear Label Holder Fits 36" Shelf	1 lb
QPLH35C	35-1/2" Clear Label Holder Fits 42" Shelf	1 lb
QPLH41C	41-1/2" Clear Label Holder Fits 48" Shelf	1 lb
QPLH47C	47-1/2" Clear Label Holder Fits 54" Shelf	1 lb
QPLH53C	53-1/2" Clear Label Holder Fits 60" Shelf	1 lb
QPLH65C	65-1/2" Clear Label Holder Fits 72" Shelf	1 lb
Millenia Laser and Inkjet Label Inserts		
QPLHI-3	3" Inserts (8-1/2" x 11" Sheets)	1 lb
QPLHI-5	5-1/2" Inserts (8-1/2" x 11" Sheets)	1 lb



CLEAR LABEL HOLDER WITH 3" INSERTS
QPLH29C + QPLHI-3

MOBILE APPLICATIONS



MOBILE KIT
QPPSC-5S

Includes four 5"x1-1/4" Polymer swivel casters, 2 with brake and four donut bumpers. Up to 800 lb. mobile load capacity (evenly distributed)

ADD-ON UNIT CAPABILITY

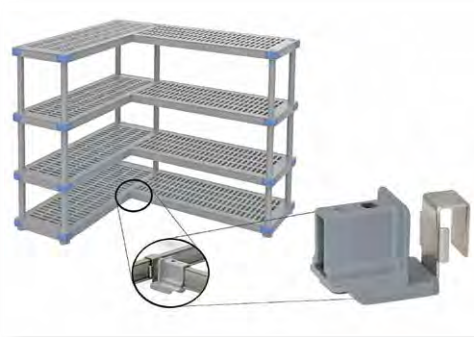

BEAM CONNECTOR ADAPTER
QPS-HOOK

Hooks only needed on "L" shape configurations
*Recommended for stationary units only

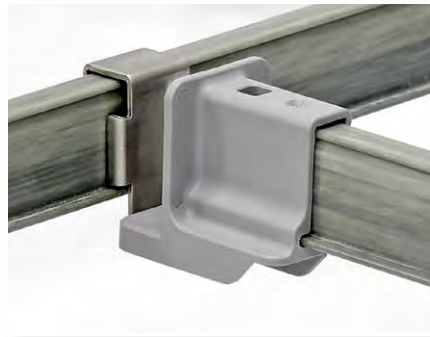

CORNER COVER ADAPTER
QP-ADC

Must be purchased with all Add-On units
(Sold as 8-pack)



Accessories

WEIGHT SUPPORT

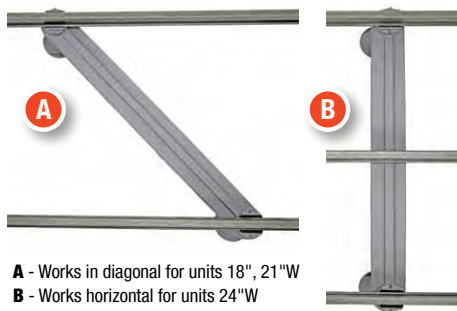

A - Works in diagonal for units 18", 21"W
B - Works horizontal for units 24"W



WALL BRACKET
QP-WMB

Used to hold a shelf unit from tipping over (Sold as 2-pack)
*Recommended for stationary units only

DUNNAGE SUPPORT STAND*
QPDS

Allows for additional weight and stability
*Extra reinforcement dunnage stand recommended for units with 54" and longer shelves

Millenia Platforms



All platform units consist of 1 shelf and 4 14" posts. **Color:** Gray

MODEL NO.	NOMINAL DIMENSIONS W" x L" x H"	SHIP WGT
Millenia Vented Platforms		
QP183614VP	18" x 36" x 14"	12 lbs
QP184814VP	18" x 48" x 14"	14 lbs
QP186014VP	18" x 60" x 14"	16 lbs
QP243614VP	24" x 36" x 14"	15 lbs
QP244814VP	24" x 48" x 14"	17 lbs
QP246014VP	24" x 60" x 14"	20 lbs
Millenia Solid Platforms		
QP183614SP	18" x 36" x 14"	13 lbs
QP184814SP	18" x 48" x 14"	15 lbs
QP186014SP	18" x 60" x 14"	17 lbs
QP243614SP	24" x 36" x 14"	16 lbs
QP244814SP	24" x 48" x 14"	19 lbs
QP246014SP	24" x 60" x 14"	22 lbs

Up to **1,000 lb.**
LOAD CAPACITY

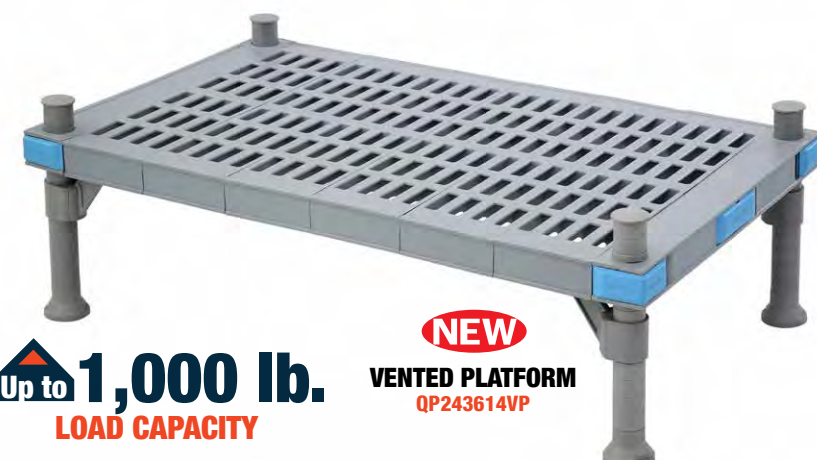

NEW
VENTED PLATFORM
QP243614VP

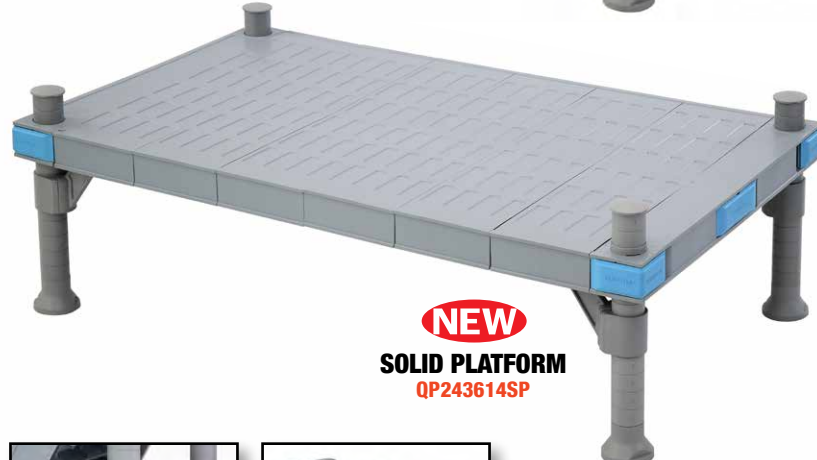

NEW
SOLID PLATFORM
QP243614SP



NEW
GUSSETS
QPG
Included with all shelves for extra support (Sold as 4-pack)



Millenia Drying Racks



BUILT FOR EFFICIENT AND CONVENIENT DRYING **NEW**

Drying racks allow items to be spread out reducing the risk of mold and bacteria growth. All drying rack complete units include 4 shelf frames with corresponding cradles or shelf plates, 4 posts and mobile kit.

MODEL NO.	NOMINAL DIMENSIONS W" x L" x H"	SHIP WGT
Millenia Universal Drying Racks		
QPM243068DR	24" x 30" x 68"	58 lbs
QPM244268DR	24" x 42" x 68"	67 lbs
QPM245468DR	24" x 54" x 68"	78 lbs
Millenia Pronged Drying Racks		
QPM243068PDR1	24" x 30" x 68"	54 lbs
QPM244268PDR1	24" x 42" x 68"	62 lbs
QPM245468PDR1	24" x 54" x 68"	70 lbs
QPM243068PDR2	24" x 30" x 68"	62 lbs
QPM244268PDR2	24" x 42" x 68"	74 lbs
QPM245468PDR2	24" x 54" x 68"	86 lbs
Millenia Waved Drying Racks		
QPM243068WDR	24" x 30" x 68"	62 lbs
QPM244268WDR	24" x 42" x 68"	74 lbs
QPM245468WDR	24" x 54" x 68"	86 lbs



PRONGED DRYING RACK COMPLETE UNITS
QPM244268PDR2



WAVED DRYING RACK COMPLETE UNITS
QPM244268WDR



UNIVERSAL DRYING RACK COMPLETE UNITS
QPM244268DR



SANITATION WITH DURABILITY



SHELF FRAMES

- QP2430F
- QP2442F
- QP2454F

Shelf frames are needed in order to use drying cradles.

DRYING CRADLES

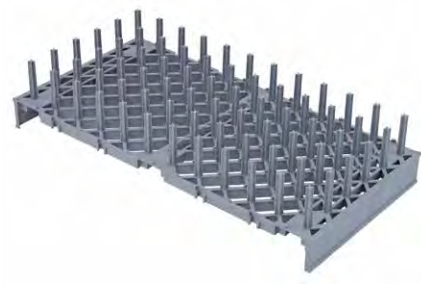

PRONGED DRYING CRADLE
QPDR1

Easily attaches to shelf frames. Perfect for dishes, drying cups, glassware, or trays. 1-1/2" spacing between each 2-3/4"H prong.



PRONGED DRYING CRADLE
QPDR2

Easily attaches to shelf frames. Perfect for dishes, drying cups, glassware, or trays. 2-1/2" spacing between each 2-3/4"H prong.



WAVED DRYING AND STORAGE CRADLE
QPWDR

Easily attaches to shelf frames. Perfect for drying dishes and flat boards.



Polymer Wire Shelving Units



Hybrid wire epoxy and polymer shelving. Durable polymer mat composition withstands high temperatures and daily rigorous usage and can be easily removed for cleaning by hand or industrial dish washer. All welded wire shelf frames and posts are constructed of heavy-gauge carbon steel. 15 year limited warranty on the epoxy metal finish and a lifetime limited warranty corrosion and rust free on the plastic. Super competitive cost. Twelve sizes ship in one box for super easy inventory control, shipping, and receiving.



4 SHELF UNIT
Proform Green Epoxy Finish



QUICK, EASY ASSEMBLY

Posts have a double groove visual guide feature, single circular grooves at 1" increments, and are numbered at 1" intervals. Tapered split sleeve snaps together around each post. Tapered openings in the shelf corners slide over the tapered split sleeves providing a positive lock. Shelf is assembled in minutes without the use of any special tools.



EASY TO CLEAN

Shelf plates can be easily removed for cleaning by hand or industrial dishwasher.

Up to 600-800 lb.
LOAD CAPACITY PER SHELF



PERFORMANCE FEATURES:

- 15 year limited warranty on Epoxy, Lifetime limited warranty on plastic
- Shelving unit materials:
 - Post and shelf: Proform Green Epoxy
 - Shelf Plates: Polymer mat (with antimicrobial protection)
- Easily removable and dishwasher safe shelf plates
- Smooth, vented, open grid surface allows for air circulation and minimal dust buildup
- Smooth solid mat surface retains spillage
- Wire shelving can adapt to your changing needs. By using various accessories, hundreds of shelving configurations become possible
- Posts and shelves are compatible with the industry standard wire shelving
- Architectural wire trusses increase shelf capacity
- Shelves can be loaded/unloaded easily from all sides. This open construction allows maximum use of storage cube
- Unit can be used continuously within a temperature range of -20/120°F and up to 200°F on intermittently exposure
- Up to 600-800 lb. load capacity per shelf evenly distributed
- No tools required for assembly
- National Sanitation Foundation (NSF) Approved
- Mobile capability available
- Shipped KD Class 70
- Resistant against corrosion

WIDTHS (W): 14", 18", 21", 24"
LENGTHS (L): 30", 36", 42", 48", 54", 60", 72"
HEIGHTS (H): 6", 14", 34", 54", 63", 74", 86"

SINGLE BOX UNITS ALSO AVAILABLE



SINGLE BOX SHIPMENT

SUPER LOW TRANSIT COST

INSIDE THE SINGLE BOX UNIT

- 4 - posts (2 or 3 pieces each)
- 4 - wire frames
- 4 - plastic vented or solid mats (2 or 3 pieces each)
- 4 - packs of split sleeves

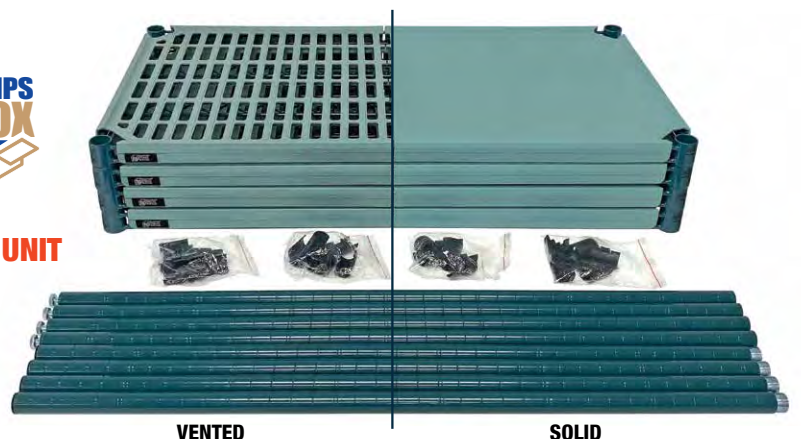

VENTED

SOLID



STORAGE POLYMER WIRE SHELVING - SHELVES AND POSTS

Polymer Wire Shelves



Hybrid wire epoxy and polymer mat shelves offer a unique combination of shelf sizes. The shelf construction is supported with architectural wire trusses to provide from up to 600 lb. to 800 lb. capacity per shelf. Vented shelf allows air to circulate for minimal dirt accumulation and light to penetrate for increased product visibility. Shelf plates are easily removable and dishwasher safe. Antimicrobial durable finish and aesthetically pleasing. National Sanitation Foundation (NSF) Approved. Plastic split sleeves are included with each shelf and replacements are available. S-Hooks are available for continuous runs of shelving. Two hooks should be placed per shelf where two posts are not utilized. No tools required for assembly.

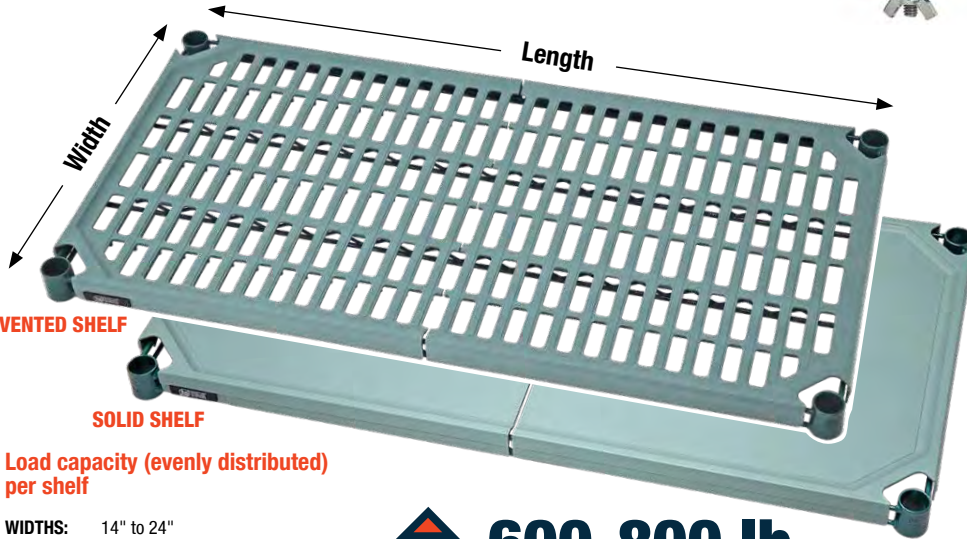

VENTED SHELF

SOLID SHELF

Load capacity (evenly distributed) per shelf

WIDTHS: 14" to 24"
LENGTHS: 800 lbs. for 30" to 48"
600 lbs. for 54" or longer

Up to 600-800 lb.
LOAD CAPACITY PER SHELF

WR-SS Split Sleeves
Additional pieces available
(Sold as 4-pairs)



S-HOOKWPM S-Hook
Additional pieces available
(Sold as 4-pairs)



VENTED MODEL NO.	SOLID MODEL NO.	SHELF W" x L"	SHIP WGT
14" Width - Shelves			
1424WPM	1424WPMS	14" x 24"	4 lbs
1430WPM	1430WPMS	14" x 30"	6 lbs
1436WPM	1436WPMS	14" x 36"	8 lbs
1442WPM	1442WPMS	14" x 42"	10 lbs
1448WPM	1448WPMS	14" x 48"	12 lbs
1454WPM	1454WPMS	14" x 54"	13 lbs
1460WPM	1460WPMS	14" x 60"	15 lbs
1472WPM	1472WPMS	14" x 72"	18 lbs
18" Width - Shelves			
1824WPM	1824WPMS	18" x 24"	5 lbs
1830WPM	1830WPMS	18" x 30"	7 lbs
1836WPM	1836WPMS	18" x 36"	9 lbs
1842WPM	1842WPMS	18" x 42"	10 lbs
1848WPM	1848WPMS	18" x 48"	11 lbs
1854WPM	1854WPMS	18" x 54"	12 lbs
1860WPM	1860WPMS	18" x 60"	13 lbs
1872WPM	1872WPMS	18" x 72"	16 lbs
21" Width - Shelves			
2124WPM	2124WPMS	21" x 24"	5 lbs
2130WPM	2130WPMS	21" x 30"	7 lbs
2136WPM	2136WPMS	21" x 36"	9 lbs
2142WPM	2142WPMS	21" x 42"	10 lbs
2148WPM	2148WPMS	21" x 48"	11 lbs
2154WPM	2154WPMS	21" x 54"	12 lbs
2160WPM	2160WPMS	21" x 60"	13 lbs
2172WPM	2172WPMS	21" x 72"	16 lbs
24" Width - Shelves			
2424WPM	2424WPMS	24" x 24"	9 lbs
2430WPM	2430WPMS	24" x 30"	11 lbs
2436WPM	2436WPMS	24" x 36"	13 lbs
2442WPM	2442WPMS	24" x 42"	14 lbs
2448WPM	2448WPMS	24" x 48"	15 lbs
2454WPM	2454WPMS	24" x 54"	16 lbs
2460WPM	2460WPMS	24" x 60"	19 lbs
2472WPM	2472WPMS	24" x 72"	23 lbs

Polymer Wire Posts



All posts are fabricated from 16 gauge carbon steel with location grooves on one inch increments and ease for shelf installation. Numbers are printed between grooves for quick assembly. Posts are double grooved in consistent intervals for quick identification. Leveling legs are enclosed with all posts. Leveling legs cannot be used in conjunction with stem casters. Custom post heights are available, call for additional information.

MODEL NO.	DESCRIPTION	SHIP WGT
P6P	6"H Post	1 lb
P14P	14"H Post	2 lbs
P34P	34"H Post	2 lbs
P54P	54"H Post	3 lbs
P63P*	63"H Post	4 lbs
P74P*	74"H Post	4 lbs
P86P*	86"H Post	5 lbs
P96P	96"H Post	6 lbs

*PRE-INSERTED LEVELERS For easy installation, 63", 74" and 86" posts are available with pre-inserted leveler and bolt by adding an X to the Model No. P74PX

**CUSTOM POST HEIGHTS
ALSO AVAILABLE**

LASER PRINTED NUMBERS
For quick shelf positioning

DOUBLE GROOVES
For quick identification

W-PLI Post Insert
Additional pieces available
(Sold as 4-pack)

W-PLB Post Leveler adjusts up or down allowing height flexibility
(Sold as 4-pack)

FP Foot Plate
W-FG Floor Guides
(Sold separately as 4-pack)



Foot Plate

Floor Guides

W-PC-STUD Threaded Stud Connector can be utilized to connect two posts enabling any post height to be achieved. Must be used with **WR-WMB** to secure to wall
See pg. 32



Post Cap



W-PC Replacement Post Cap
(Sold as 4-pack)





4 Shelf Polymer Wire Shelving Unit

Up to 600-800 lb.
LOAD CAPACITY PER SHELF

ADD SUFFIX "S" TO MODEL NO. TO ORDER SOLID SHELF UNIT
Ex. WR63-1424WPM**S** or WR63-1424WPM**S-5**

MODEL NO.	DIMENSIONS W" x L" x H"	SHIP WGT	MODEL NO.	DIMENSIONS W" x L" x H"	SHIP WGT	MODEL NO.	DIMENSIONS W" x L" x H"	SHIP WGT
63"H - 4 Shelves Units			74"H - 4 Shelves Units			86"H - 4 Shelves Units		
WR63-1424WPM	14" x 24" x 63"	32 lbs	WR74-1424WPM	14" x 24" x 74"	32 lbs	WR86-1424WPM	14" x 24" x 86"	36 lbs
WR63-1430WPM	14" x 30" x 63"	41 lbs	WR74-1430WPM	14" x 30" x 74"	41 lbs	WR86-1430WPM	14" x 30" x 86"	45 lbs
WR63-1436WPM	14" x 36" x 63"	48 lbs	WR74-1436WPM	14" x 36" x 74"	48 lbs	WR86-1436WPM	14" x 36" x 86"	52 lbs
WR63-1442WPM	14" x 42" x 63"	56 lbs	WR74-1442WPM	14" x 42" x 74"	56 lbs	WR86-1442WPM	14" x 42" x 86"	60 lbs
WR63-1448WPM	14" x 48" x 63"	64 lbs	WR74-1448WPM	14" x 48" x 74"	64 lbs	WR86-1448WPM	14" x 48" x 86"	68 lbs
WR63-1454WPM	14" x 54" x 63"	70 lbs	WR74-1454WPM	14" x 54" x 74"	70 lbs	WR86-1454WPM	14" x 54" x 86"	74 lbs
WR63-1460WPM	14" x 60" x 63"	76 lbs	WR74-1460WPM	14" x 60" x 74"	76 lbs	WR86-1460WPM	14" x 60" x 86"	80 lbs
WR63-1472WPM	14" x 72" x 63"	89 lbs	WR74-1472WPM	14" x 72" x 74"	89 lbs	WR86-1472WPM	14" x 72" x 86"	93 lbs
WR63-1824WPM	18" x 24" x 63"	36 lbs	WR74-1824WPM	18" x 24" x 74"	36 lbs	WR86-1824WPM	18" x 24" x 86"	40 lbs
WR63-1830WPM	18" x 30" x 63"	48 lbs	WR74-1830WPM*	18" x 30" x 74"	48 lbs	WR86-1830WPM	18" x 30" x 86"	52 lbs
WR63-1836WPM	18" x 36" x 63"	56 lbs	WR74-1836WPM*	18" x 36" x 74"	56 lbs	WR86-1836WPM	18" x 36" x 86"	60 lbs
WR63-1842WPM	18" x 42" x 63"	64 lbs	WR74-1842WPM*	18" x 42" x 74"	64 lbs	WR86-1842WPM	18" x 42" x 86"	68 lbs
WR63-1848WPM	18" x 48" x 63"	68 lbs	WR74-1848WPM*	18" x 48" x 74"	68 lbs	WR86-1848WPM	18" x 48" x 86"	72 lbs
WR63-1854WPM	18" x 54" x 63"	76 lbs	WR74-1854WPM	18" x 54" x 74"	76 lbs	WR86-1854WPM	18" x 54" x 86"	80 lbs
WR63-1860WPM	18" x 60" x 63"	84 lbs	WR74-1860WPM	18" x 60" x 74"	84 lbs	WR86-1860WPM	18" x 60" x 86"	88 lbs
WR63-1872WPM	18" x 72" x 63"	96 lbs	WR74-1872WPM	18" x 72" x 74"	96 lbs	WR86-1872WPM	18" x 72" x 86"	100 lbs
WR63-2124WPM	21" x 24" x 63"	36 lbs	WR74-2124WPM	21" x 24" x 74"	36 lbs	WR86-2124WPM	21" x 24" x 86"	40 lbs
WR63-2130WPM	21" x 30" x 63"	56 lbs	WR74-2130WPM*	21" x 30" x 74"	56 lbs	WR86-2130WPM	21" x 30" x 86"	60 lbs
WR63-2136WPM	21" x 36" x 63"	64 lbs	WR74-2136WPM*	21" x 36" x 74"	64 lbs	WR86-2136WPM	21" x 36" x 86"	68 lbs
WR63-2142WPM	21" x 42" x 63"	68 lbs	WR74-2142WPM*	21" x 42" x 74"	68 lbs	WR86-2142WPM	21" x 42" x 86"	72 lbs
WR63-2148WPM	21" x 48" x 63"	76 lbs	WR74-2148WPM*	21" x 48" x 74"	76 lbs	WR86-2148WPM	21" x 48" x 86"	80 lbs
WR63-2154WPM	21" x 54" x 63"	84 lbs	WR74-2154WPM	21" x 54" x 74"	84 lbs	WR86-2154WPM	21" x 54" x 86"	88 lbs
WR63-2160WPM	21" x 60" x 63"	92 lbs	WR74-2160WPM	21" x 60" x 74"	92 lbs	WR86-2160WPM	21" x 60" x 86"	96 lbs
WR63-2172WPM	21" x 72" x 63"	104 lbs	WR74-2172WPM	21" x 72" x 74"	104 lbs	WR86-2172WPM	21" x 72" x 86"	108 lbs
WR63-2424WPM	24" x 24" x 63"	52 lbs	WR74-2424WPM	24" x 24" x 74"	52 lbs	WR86-2424WPM	24" x 24" x 86"	56 lbs
WR63-2430WPM	24" x 30" x 63"	64 lbs	WR74-2430WPM*	24" x 30" x 74"	64 lbs	WR86-2430WPM	24" x 30" x 86"	68 lbs
WR63-2436WPM	24" x 36" x 63"	68 lbs	WR74-2436WPM*	24" x 36" x 74"	68 lbs	WR86-2436WPM	24" x 36" x 86"	72 lbs
WR63-2442WPM	24" x 42" x 63"	72 lbs	WR74-2442WPM*	24" x 42" x 74"	72 lbs	WR86-2442WPM	24" x 42" x 86"	76 lbs
WR63-2448WPM	24" x 48" x 63"	80 lbs	WR74-2448WPM*	24" x 48" x 74"	80 lbs	WR86-2448WPM	24" x 48" x 86"	84 lbs
WR63-2454WPM	24" x 54" x 63"	92 lbs	WR74-2454WPM	24" x 54" x 74"	92 lbs	WR86-2454WPM	24" x 54" x 86"	96 lbs
WR63-2460WPM	24" x 60" x 63"	96 lbs	WR74-2460WPM	24" x 60" x 74"	96 lbs	WR86-2460WPM	24" x 60" x 86"	100 lbs
WR63-2472WPM	24" x 72" x 63"	112 lbs	WR74-2472WPM	24" x 72" x 74"	112 lbs	WR86-2472WPM	24" x 72" x 86"	116 lbs

*PACKAGED AS SINGLE BOX SHELVING UNITS

5 Shelf Polymer Wire Shelving Unit

PRE-INSERTED LEVELERS For easy installation, 63", 74" and 86" posts are available with pre-inserted leveler and bolt by adding an X to the Model No. WR86-2436WPMX, WR86-2436WPM-5X.

MODEL NO.	DIMENSIONS W" x L" x H"	SHIP WGT	MODEL NO.	DIMENSIONS W" x L" x H"	SHIP WGT
74"H - 5 Shelves Units			86"H - 5 Shelves Units		
WR74-1424WPM-5	14" x 24" x 74"	36 lbs	WR86-1424WPM-5	14" x 24" x 86"	40 lbs
WR74-1430WPM-5	14" x 30" x 74"	48 lbs	WR86-1430WPM-5	14" x 30" x 86"	52 lbs
WR74-1436WPM-5	14" x 36" x 74"	56 lbs	WR86-1436WPM-5	14" x 36" x 86"	60 lbs
WR74-1442WPM-5	14" x 42" x 74"	66 lbs	WR86-1442WPM-5	14" x 42" x 86"	70 lbs
WR74-1448WPM-5	14" x 48" x 74"	76 lbs	WR86-1448WPM-5	14" x 48" x 86"	80 lbs
WR74-1454WPM-5	14" x 54" x 74"	83 lbs	WR86-1454WPM-5	14" x 54" x 86"	87 lbs
WR74-1460WPM-5	14" x 60" x 74"	91 lbs	WR86-1460WPM-5	14" x 60" x 86"	95 lbs
WR74-1472WPM-5	14" x 72" x 74"	108 lbs	WR86-1472WPM-5	14" x 72" x 86"	112 lbs
WR74-1824WPM-5	18" x 24" x 74"	41 lbs	WR86-1824WPM-5	18" x 24" x 86"	45 lbs
WR74-1830WPM-5	18" x 30" x 74"	56 lbs	WR86-1830WPM-5	18" x 30" x 86"	60 lbs
WR74-1836WPM-5	18" x 36" x 74"	66 lbs	WR86-1836WPM-5	18" x 36" x 86"	70 lbs
WR74-1842WPM-5	18" x 42" x 74"	76 lbs	WR86-1842WPM-5	18" x 42" x 86"	80 lbs
WR74-1848WPM-5	18" x 48" x 74"	81 lbs	WR86-1848WPM-5	18" x 48" x 86"	85 lbs
WR74-1854WPM-5	18" x 54" x 74"	91 lbs	WR86-1854WPM-5	18" x 54" x 86"	95 lbs
WR74-1860WPM-5	18" x 60" x 74"	101 lbs	WR86-1860WPM-5	18" x 60" x 86"	105 lbs
WR74-1872WPM-5	18" x 72" x 74"	116 lbs	WR86-1872WPM-5	18" x 72" x 86"	120 lbs
WR74-2124WPM-5	21" x 24" x 74"	41 lbs	WR86-2124WPM-5	21" x 24" x 86"	45 lbs
WR74-2130WPM-5	21" x 30" x 74"	66 lbs	WR86-2130WPM-5	21" x 30" x 86"	70 lbs
WR74-2136WPM-5	21" x 36" x 74"	76 lbs	WR86-2136WPM-5	21" x 36" x 86"	80 lbs
WR74-2142WPM-5	21" x 42" x 74"	81 lbs	WR86-2142WPM-5	21" x 42" x 86"	85 lbs
WR74-2148WPM-5	21" x 48" x 74"	91 lbs	WR86-2148WPM-5	21" x 48" x 86"	95 lbs
WR74-2154WPM-5	21" x 54" x 74"	101 lbs	WR86-2154WPM-5	21" x 54" x 86"	105 lbs
WR74-2160WPM-5	21" x 60" x 74"	111 lbs	WR86-2160WPM-5	21" x 60" x 86"	115 lbs
WR74-2172WPM-5	21" x 72" x 74"	126 lbs	WR86-2172WPM-5	21" x 72" x 86"	130 lbs
WR74-2424WPM-5	24" x 24" x 74"	61 lbs	WR86-2424WPM-5	24" x 24" x 86"	65 lbs
WR74-2430WPM-5	24" x 30" x 74"	76 lbs	WR86-2430WPM-5	24" x 30" x 86"	80 lbs
WR74-2436WPM-5	24" x 36" x 74"	81 lbs	WR86-2436WPM-5	24" x 36" x 86"	85 lbs
WR74-2442WPM-5	24" x 42" x 74"	86 lbs	WR86-2442WPM-5	24" x 42" x 86"	90 lbs
WR74-2448WPM-5	24" x 48" x 74"	96 lbs	WR86-2448WPM-5	24" x 48" x 86"	100 lbs
WR74-2454WPM-5	24" x 54" x 74"	111 lbs	WR86-2454WPM-5	24" x 54" x 86"	115 lbs
WR74-2460WPM-5	24" x 60" x 74"	116 lbs	WR86-2460WPM-5	24" x 60" x 86"	120 lbs
WR74-2472WPM-5	24" x 72" x 74"	136 lbs	WR86-2472WPM-5	24" x 72" x 86"	140 lbs





STORAGE

POLYMER WIRE SHELVING - DRYING AND CAN RACK UNITS

Drying Rack - 4 Shelf Units

Drying rack allows you to store and dry cutting boards, trays and pans. All units come with 2 cutting board/tray and 2 pan drying racks. **Finish:** Proform Green/Gray Epoxy

MODEL NO.	DIMENSIONS W" x L" x H"	SHIP WGT
Complete Drying Rack Units		
M2436W46DR	24" x 36" x 63"	134 lbs
M2448W46DR	24" x 48" x 63"	162 lbs
M2460W46DR	24" x 60" x 63"	194 lbs



MOBILIZE YOUR WIRE SHELVING

DB - Donut Bumper
Non-marking donut bumper used to protect walls and help cushion impact.

WR-00H (Mobile Kit)
Set of four swivel thermoplastic resin 5" x 1-1/4" casters, two with brakes. Can be used with all units shown. 1,200 lb. load capacity.



NEW
M2448W46DR
Green Polymer and Gray Epoxy Finish

FITS FROM 24-43 TRAYS PER RACK

FITS FROM 10-17 PANS PER RACK

Can Rack - 4 Shelf Units

Can rack is front-loading, front-dispensing. 36" unit come with 4 can racks per shelf, 48" unit come with 5 can racks per shelf. **Finish:** Proform Green/Gray Epoxy

MODEL NO.	DIMENSIONS W" x L" x H"	SHIP WGT
Complete Can Rack Units		
WR74-CR2436WPM	24" x 36" x 74"	152 lbs
WR74-CR2448WPM	24" x 48" x 74"	181 lbs

FITS FROM 8-#10 OR 12-#5 CANS PER RACK

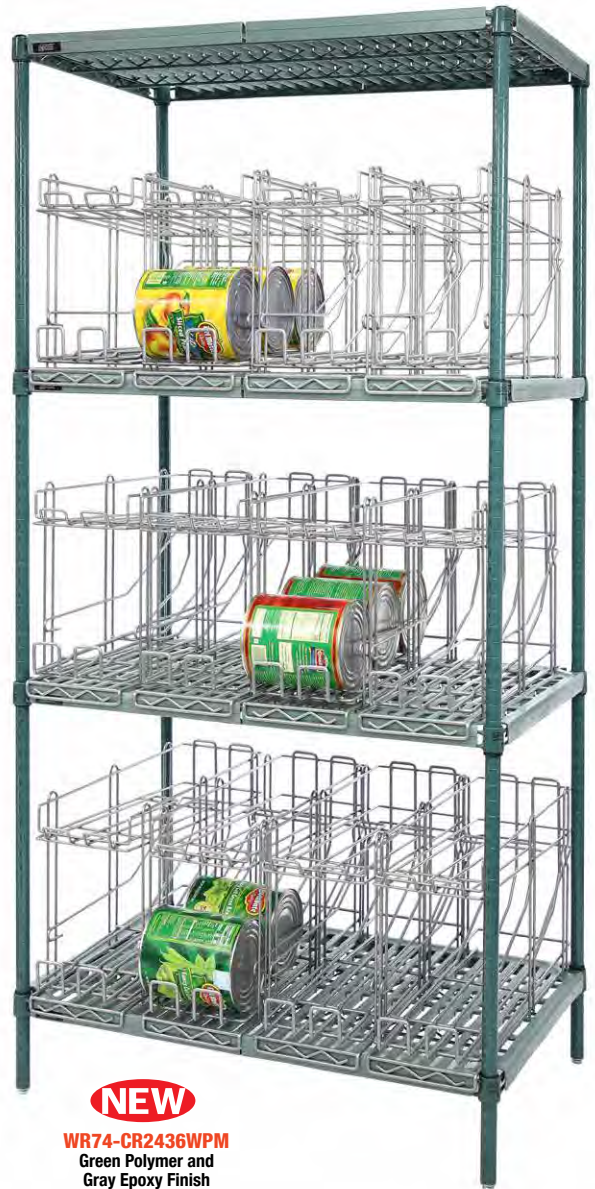

NEW
WR74-CR2436WPM
Green Polymer and Gray Epoxy Finish



S-Hooks **NEW**

For continuous runs of shelving. Two hooks should be used per shelf where two posts are not utilized. Sold as an 8 pack.
Finish: Proform Green/Stainless Steel



S-HOOKWPM
Proform Green Epoxy/
Stainless Steel



Label Holder



ULH3C
Label Holder
1-3/8" x 3"
Other length sizes
ULH33C 33"
ULH45C 45"
ULH57C 57"
ULH69C 69"

EASY IDENTIFICATION OF AISLES/ROWS CONTENTS

Post Label Holders

New post label holders come in two sizes and allow for easy identification of aisles/rows as well as of wire cart contents. Attach to standard 1" diameter posts. Each package includes 12 clear holders and corresponding printer friendly sheet labels.

MODEL NO.	DIMENSIONS W" x L"	PKG QTY	SHIP WGT
PLH1X6C	1" x 6"	12 pcs	1 lb
PLH2X4C	2" x 4"	12 pcs	1 lb



PLH1X6C
Post Label
1" x 6"



PLH2X4C
Post Label
2" x 4"

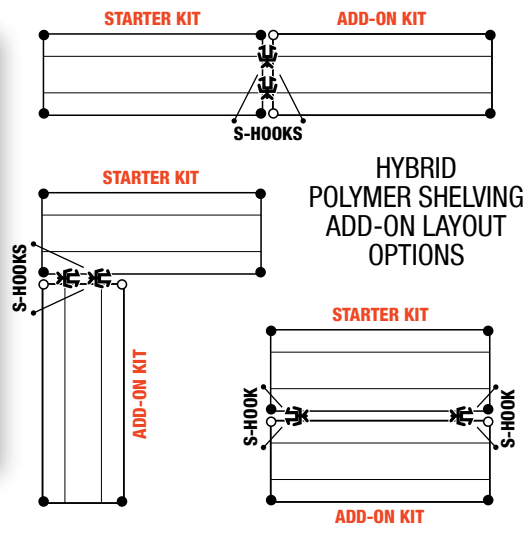

Tray/Pan Drying Racks



Drying rack allow you to store and dry cutting boards, trays and pans. Rack fits on 24" deep shelves fitting from 43 trays to 17 pans per rack. **Finish:** Gray Epoxy

MODEL NO.	DIMENSIONS W" x L" x H"	TRAYS/PANS CAP	SHIP WGT
Cutting Board/Tray Drying Racks 1-1/8" Spacing			
TDR24361GY	24" x 36" x 8"	24	15 lbs
TDR24481GY	24" x 48" x 8"	34	21 lbs
TDR24601GY	24" x 60" x 8"	43	26 lbs
Pan Drying Racks 3" Spacing			
TDR24363GY	24" x 36" x 8"	10	11 lbs
TDR24483GY	24" x 48" x 8"	14	15 lbs
TDR24603GY	24" x 60" x 8"	17	18 lbs

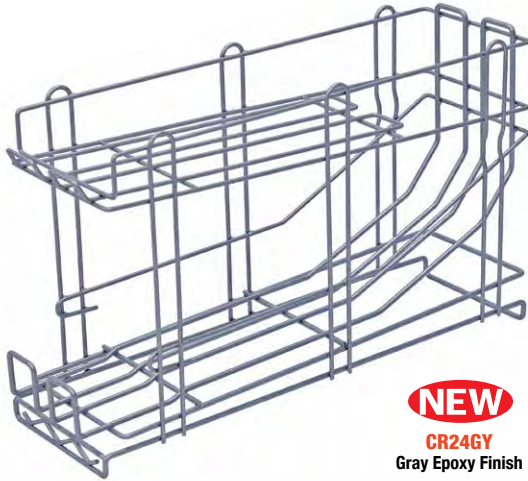

NEW
CR24GY
Gray Epoxy Finish

Can Racks



Can rack is front-loading, front-dispensing. Each rack fits on 24" deep shelves and can fit from 8#10 or 12#5 cans per rack. **Finish:** Gray Epoxy

MODEL NO.	DIMENSIONS W" x L" x H"	SHIP WGT
Can Racks		
CR24GY	25-1/2" x 8" x 15"	9 lbs

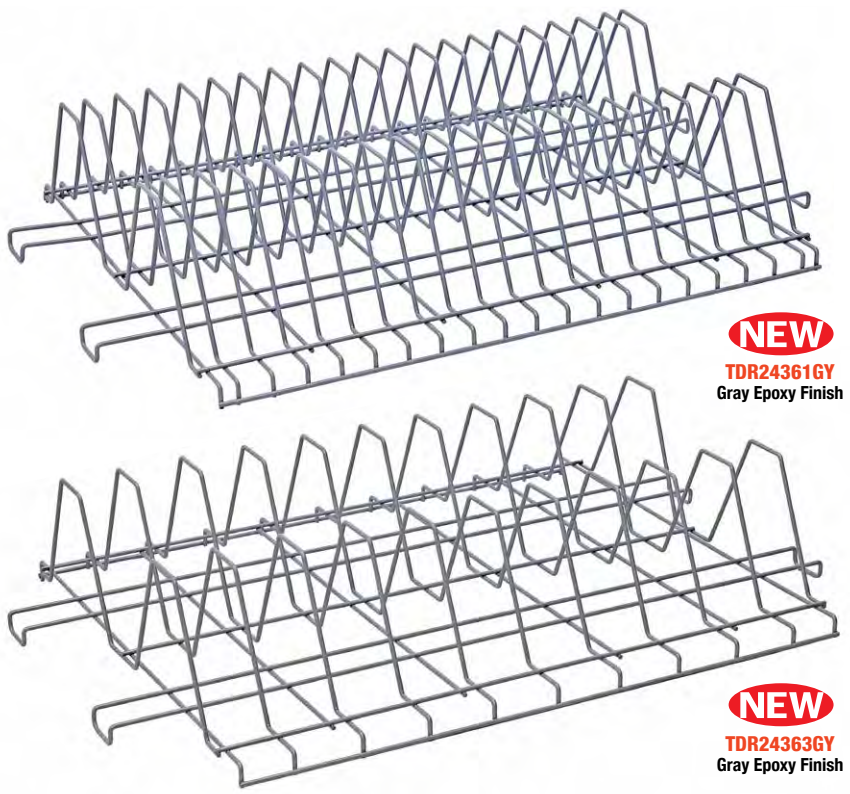

NEW
TDR24361GY
Gray Epoxy Finish

NEW
TDR24363GY
Gray Epoxy Finish



Wire Shelves



Genuine Quantum modular wire systems offer a unique combination of shelf and post sizes in a variety of finishes to work in any application. The all welded shelf construction is supported with architectural wire trusses to provide between up to 600 lb. and 1,000 lb. capacity per shelf.



- CHROME
- 304 STAINLESS STEEL
- PROFORM GREEN EPOXY
- GRAY EPOXY
- BLACK EPOXY

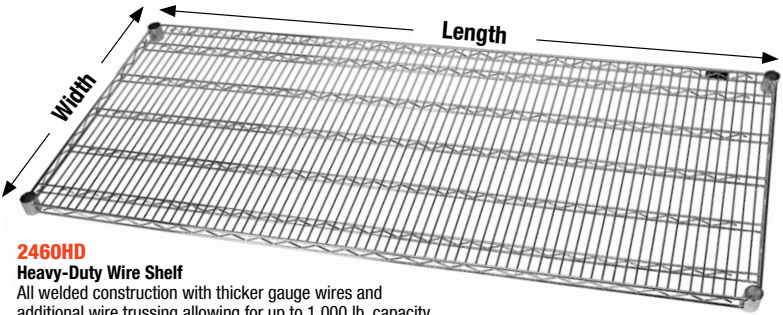

2460HD
Heavy-Duty Wire Shelf
All welded construction with thicker gauge wires and additional wire trussing allowing for up to 1,000 lb. capacity



Up to 600-800 lb.
LOAD CAPACITY PER SHELF

Up to 1,000 lb.
LOAD CAPACITY PER HEAVY-DUTY SHELF (HD Models)

SHELF W" x L"	SHIP WGT	CHROME	STAINLESS STEEL	EPOXY		
		MODEL NO.	MODEL NO.	PROFORM GREEN MODEL NO.	GRAY MODEL NO.	BLACK MODEL NO.
12" Deep - Wire Shelves						
12" x 24"	6 lbs	1224C	-	1224P	1224GY	1224BK
12" x 30"	6 lbs	1230C	-	1230P	1230GY	1230BK
12" x 36"	7 lbs	1236C	1236S	1236P	1236GY	1236BK
12" x 42"	8 lbs	1242C	-	1242P	1242GY	1242BK
12" x 48"	9 lbs	1248C	1248S	1248P	1248GY	1248BK
12" x 60"	14 lbs	1260C	1260S	1260P	1260GY	1260BK
12" x 72"	17 lbs	1272C	1272S	1272P	1272GY	1272BK
14" Deep - Wire Shelves						
14" x 24"	6 lbs	1424C	-	1424P	1424GY	1424BK
14" x 30"	7 lbs	1430C	1430S	1430P	1430GY	1430BK
14" x 36"	8 lbs	1436C	1436S	1436P	1436GY	1436BK
14" x 42"	10 lbs	1442C	1442S	1442P	1442GY	1442BK
14" x 48"	11 lbs	1448C	1448S	1448P	1448GY	1448BK
14" x 54"	12 lbs	1454C	1454S	1454P	1454GY	1454BK
14" x 60"	14 lbs	1460C	1460S	1460P	1460GY	1460BK
14" x 72"	17 lbs	1472C	1472S	1472P	1472GY	1472BK
18" Deep - Wire Shelves						
18" x 24"	7 lbs	1824C	1824S	1824P	1824GY	1824BK
18" x 30"	8 lbs	1830C	1830S	1830P	1830GY	1830BK
18" x 36"	10 lbs	1836C	1836S	1836P	1836GY	1836BK
18" x 42"	11 lbs	1842C	1842S	1842P	1842GY	1842BK
18" x 48"	14 lbs	1848C	1848S	1848P	1848GY	1848BK
18" x 54"	15 lbs	1854C	1854S	1854P	1854GY	1854BK
18" x 60"	17 lbs	1860C	1860S	1860P	1860GY	1860BK
18" x 72"	20 lbs	1872C	1872S	1872P	1872GY	1872BK
21" Deep - Wire Shelves						
21" x 24"	8 lbs	2124C	2124S	2124P	2124GY	2124BK
21" x 30"	9 lbs	2130C	2130S	2130P	2130GY	2130BK
21" x 36"	11 lbs	2136C	2136S	2136P	2136GY	2136BK
21" x 42"	12 lbs	2142C	2142S	2142P	2142GY	2142BK
21" x 48"	14 lbs	2148C	2148S	2148P	2148GY	2148BK
21" x 54"	16 lbs	2154C	2154S	2154P	2154GY	2154BK
21" x 60"	18 lbs	2160C	2160S	2160P	2160GY	2160BK
21" x 72"	24 lbs	2172C	2172S	2172P	2172GY	2172BK
24" Deep - Wire Shelves						
24" x 24"	9 lbs	2424C	2424S	2424P	2424GY	2424BK
24" x 30"	11 lbs	2430C	2430S	2430P	2430GY	2430BK
24" x 36"	13 lbs	2436C	2436S	2436P	2436GY	2436BK
24" x 42"	15 lbs	2442C	2442S	2442P	2442GY	2442BK
24" x 48"	16 lbs	2448C	2448S	2448P	2448GY	2448BK
24" x 54"	18 lbs	2454C	2454S	2454P	2454GY	2454BK
24" x 60"	21 lbs	2460C	2460S	2460P	2460GY	2460BK
24" x 66"	23 lbs	2466C	-	2466P	2466GY	-
24" x 72"	26 lbs	2472C	2472S	2472P	2472GY	2472BK
24" Deep Heavy-Duty - Wire Shelves (1,000 lb. capacity)						
24" x 60"	25 lbs	2460CHD	-	-	-	-
24" x 72"	30 lbs	2472CHD	-	-	-	-
30" Deep - Wire Shelves						
30" x 30"	12 lbs	-	-	-	3030GY	-
30" x 36"	15 lbs	3036C	3036S	3036P	3036GY	3036BK
30" x 42"	18 lbs	3042C	3042S	3042P	3042GY	3042BK
30" x 48"	21 lbs	3048C	3048S	3048P	3048GY	3048BK
30" x 60"	27 lbs	3060C	3060S	3060P	3060GY	3060BK
30" x 72"	31 lbs	3072C	3072S	3072P	3072GY	3072BK
36" Deep - Wire Shelves						
36" x 36"	18 lbs	3636C	3636S	3636P	3636GY	3636BK
36" x 48"	23 lbs	3648C	3648S	3648P	3648GY	3648BK
36" x 60"	29 lbs	3660C	3660S	3660P	3660GY	3660BK
36" x 72"	35 lbs	3672C	3672S	3672P	3672GY	3672BK

PERFORMANCE FEATURES:

- All welded construction with additional wire trussing for high strength characteristics
- Top mat wires run front to back (except on 12" x 36" size) for ease of loading and unloading and superior strength
- Wire allows air to circulate and light to penetrate for increased product visibility
- Minimal dirt accumulation
- Split sleeve connectors secure shelf corners to posts
- Numbered grooved posts on 1 inch increments for quick assembly
- No tools required for assembly
- Adjustable foot levelers allow for perfect stability
- Durable finishes
- Aesthetically pleasing
- Optional accessories (see pgs. 30-35)
- National Sanitation Foundation (NSF) Approved
- Shipped KD Class 70
- Up to 600 and 1,000 lb. capacity per shelf



Posts



All posts are fabricated from 16 gauge carbon steel with location grooves on one inch increments and ease for shelf installation. Numbers are printed between grooves for quick assembly. Posts are double grooved in consistent intervals for quick identification. Leveling legs are enclosed with all posts. Leveling legs cannot be used in conjunction with stem casters. Custom post heights are available, call for additional information.

DESCRIPTION	SHIP WGT	CHROME	STAINLESS STEEL	EPOXY		
		MODEL NO.	MODEL NO.	PROFORM GREEN	GRAY	BLACK
6"H Post	1 lb	P6C	P6S	P6P	P6GY	P6BK
14"H Post	2 lbs	P14C	P14S	P14P	P14GY	P14BK
34"H Post	2 lbs	P34C	P34S	P34P	P34GY	P34BK
36"H Post	2 lbs	P36C	-	-	-	-
39"H Post	2 lbs	P39C	-	-	-	P39BK
42"H Post	2 lbs	-	P42S	-	-	-
54"H Post	3 lbs	P54C	P54S	P54P	P54GY	P54BK
63"H Post	4 lbs	P63C*	P63S	P63P*	P63GY*	P63BK*
74"H Post	4 lbs	P74C*	P74S	P74P*	P74GY*	P74BK*
86"H Post	5 lbs	P86C*	P86S	P86P*	P86GY*	P86BK*
96"H Post	6 lbs	P96C	P96S	P96P	P96GY	P96BK

***PRE-INSERTED LEVELERS** For easy installation, 63", 74" and 86" posts are available with pre-inserted leveler and bolt by adding an **X** to the Model No. P74C**X**

W-PC
Replacement Post Cap
Additional pieces available
(Sold as 4-pack)

W-PC-STUD
Threaded **Stud Connector** can be utilized to connect two posts enabling any post height to be achieved. Must be used with **WR-WMB** to secure to wall
See **pg. 32**

LASER PRINTED NUMBERS
For quick shelf positioning

W-PLI
Post Insert
Additional pieces available
(Sold as 4-pack)

W-PLB
Post Leveler adjusts up or down allowing height flexibility. Additional pieces available
(Sold as 4-pack)



EASY IDENTIFICATION OF AISLES/ROWS CONTENTS

Post Label Holders

New post label holders come in two sizes and allow for easy identification of aisles/rows as well as of wire cart contents. Attach to standard 1" diameter posts. Each package includes 12 clear holders and corresponding printer friendly sheet labels.

MODEL NO.	DIMENSIONS W" x L"	PKG QTY	SHIP WGT
PLH1X6C	1" x 6"	12 pcs	1 lb
PLH2X4C	2" x 4"	12 pcs	1 lb

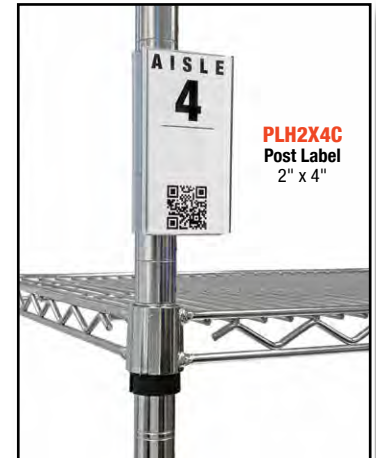

ASSEMBLING WIRE SHELVING UNITS IS AS EASY AS 1 - 2 - 3...



1 Snap plastic sleeve around post.



2 Slide shelf over sleeve for secure locking.

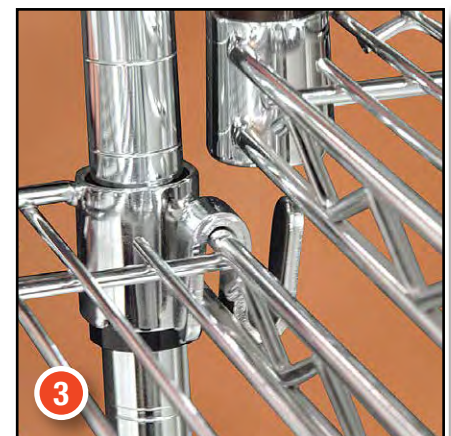

3 Two "S-Hooks" are used to connect add-on wire shelf to starter units.



STORAGE

WIRE SHELVING - 54" UNITS STARTER AND ADD-ON KITS

Starter Kits



Heavy-duty shelving units allow up to 800 lb. shelf capacity. Starter kits come complete with 4 posts and 4 or 5 shelves. Additional shelves may be purchased separately. See chart on **pg. 24**. Mobilize starter kit shelving unit using optional mobile kit, **WR-00H**, see **pg. 33**. **Finishes:** Chrome, Stainless Steel, Proform Green, Gray and Black Epoxy

Up to 600-800 lb.
LOAD CAPACITY PER SHELF

TO CHOOSE FINISH ADD FINISH SUFFIX TO MODEL NO.

Ex: **Chrome** WR54-1236C
Stainless WR54-1236S
Proform Green WR54-1236P
Gray WR54-1236GY
Black WR54-1236BK

Ex: **Chrome** WR54-1236C-5
Stainless WR54-1236S-5
Proform Green WR54-1236P-5
Gray WR54-1236GY-5
Black WR54-1236BK-5

Chrome
Stainless
Proform Green
GY Gray
BK Black



MOBILIZE YOUR WIRE SHELVING

DB - Donut Bumper
Non-marking donut bumper used to protect walls and help cushion impact.

WR-00H (Mobile Kit)*
Set of four swivel thermoplastic resin 5" x 1-1/4" casters, two with brakes. Can be used with all units shown. Up to 1,200 lb. load capacity. *Mobile kits recommended only for shelves 18" and deeper.



4 SHELF STARTER KIT
Stainless Steel Finish

54"H - WIRE SHELVING 4 SHELVES				54"H - WIRE SHELVING 5 SHELVES				AVAILABLE	
STARTER KIT		ADD-ON KIT		STARTER KIT		ADD-ON KIT		FINISHES	
SHELF W" x L"	MODEL NO.	SHIP WGT	MODEL NO.	SHIP WGT	MODEL NO.	SHIP WGT	MODEL NO.	SHIP WGT	C S P GY BK
12" x 36"	WR54-1236	40 lbs	AD54-1236	36 lbs	WR54-1236-5	47 lbs	AD54-1236-5	45 lbs	Y Y Y Y Y
12" x 42"	WR54-1242	44 lbs	AD54-1242	40 lbs	WR54-1242-5	52 lbs	AD54-1242-5	50 lbs	Y N Y Y Y
12" x 48"	WR54-1248	48 lbs	AD54-1248	44 lbs	WR54-1248-5	57 lbs	AD54-1248-5	55 lbs	Y Y Y Y Y
12" x 60"	WR54-1260	56 lbs	AD54-1260	52 lbs	WR54-1260-5	70 lbs	AD54-1260-5	68 lbs	Y Y Y Y Y
12" x 72"	WR54-1272	64 lbs	AD54-1272	60 lbs	WR54-1272-5	81 lbs	AD54-1272-5	79 lbs	Y Y Y Y Y
14" x 24"	WR54-1424	36 lbs	AD54-1424	32 lbs	WR54-1424-5	42 lbs	AD54-1424-5	40 lbs	Y N Y Y Y
14" x 30"	WR54-1430	40 lbs	AD54-1430	36 lbs	WR54-1430-5	47 lbs	AD54-1430-5	45 lbs	Y Y Y Y Y
14" x 36"	WR54-1436	44 lbs	AD54-1436	40 lbs	WR54-1436-5	52 lbs	AD54-1436-5	50 lbs	Y Y Y Y Y
14" x 42"	WR54-1442	52 lbs	AD54-1442	48 lbs	WR54-1442-5	62 lbs	AD54-1442-5	60 lbs	Y Y Y Y Y
14" x 48"	WR54-1448	56 lbs	AD54-1448	52 lbs	WR54-1448-5	67 lbs	AD54-1448-5	65 lbs	Y Y Y Y Y
14" x 54"	WR54-1454	60 lbs	AD54-1454	56 lbs	WR54-1454-5	72 lbs	AD54-1454-5	70 lbs	Y Y Y Y Y
14" x 60"	WR54-1460	68 lbs	AD54-1460	64 lbs	WR54-1460-5	82 lbs	AD54-1460-5	80 lbs	Y Y Y Y Y
14" x 72"	WR54-1472	80 lbs	AD54-1472	76 lbs	WR54-1472-5	97 lbs	AD54-1472-5	95 lbs	Y Y Y Y Y
18" x 24"	WR54-1824	40 lbs	AD54-1824	36 lbs	WR54-1824-5	47 lbs	AD54-1824-5	45 lbs	Y Y Y Y Y
18" x 30"	WR54-1830	44 lbs	AD54-1830	40 lbs	WR54-1830-5	52 lbs	AD54-1830-5	50 lbs	Y Y Y Y Y
18" x 36"	WR54-1836	52 lbs	AD54-1836	48 lbs	WR54-1836-5	62 lbs	AD54-1836-5	60 lbs	Y Y Y Y Y
18" x 42"	WR54-1842	56 lbs	AD54-1842	52 lbs	WR54-1842-5	67 lbs	AD54-1842-5	65 lbs	Y Y Y Y Y
18" x 48"	WR54-1848	60 lbs	AD54-1848	56 lbs	WR54-1848-5	74 lbs	AD54-1848-5	72 lbs	Y Y Y Y Y
18" x 54"	WR54-1854	72 lbs	AD54-1854	68 lbs	WR54-1854-5	87 lbs	AD54-1854-5	81 lbs	Y Y Y Y Y
18" x 60"	WR54-1860	80 lbs	AD54-1860	76 lbs	WR54-1860-5	97 lbs	AD54-1860-5	95 lbs	Y Y Y Y Y
18" x 72"	WR54-1872	92 lbs	AD54-1872	88 lbs	WR54-1872-5	112 lbs	AD54-1872-5	58 lbs	Y Y Y Y Y
21" x 24"	WR54-2124	44 lbs	AD54-2124	40 lbs	WR54-2124-5	52 lbs	AD54-2124-5	50 lbs	Y Y Y Y Y
21" x 30"	WR54-2130	48 lbs	AD54-2130	44 lbs	WR54-2130-5	57 lbs	AD54-2130-5	59 lbs	Y Y Y Y Y
21" x 36"	WR54-2136	56 lbs	AD54-2136	52 lbs	WR54-2136-5	67 lbs	AD54-2136-5	65 lbs	Y Y Y Y Y
21" x 42"	WR54-2142	60 lbs	AD54-2142	56 lbs	WR54-2142-5	72 lbs	AD54-2142-5	70 lbs	Y Y Y Y Y
21" x 48"	WR54-2148	68 lbs	AD54-2148	64 lbs	WR54-2148-5	82 lbs	AD54-2148-5	84 lbs	Y Y Y Y Y
21" x 54"	WR54-2154	76 lbs	AD54-2154	72 lbs	WR54-2154-5	92 lbs	AD54-2154-5	94 lbs	Y Y Y Y Y
21" x 60"	WR54-2160	84 lbs	AD54-2160	80 lbs	WR54-2160-5	102 lbs	AD54-2160-5	108 lbs	Y Y Y Y Y
21" x 72"	WR54-2172	108 lbs	AD54-2172	104 lbs	WR54-2172-5	132 lbs	AD54-2172-5	130 lbs	Y Y Y Y Y
24" x 24"	WR54-2424	48 lbs	AD54-2424	44 lbs	WR54-2424-5	57 lbs	AD54-2424-5	55 lbs	Y Y Y Y Y
24" x 30"	WR54-2430	56 lbs	AD54-2430	52 lbs	WR54-2430-5	67 lbs	AD54-2430-5	65 lbs	Y Y Y Y Y
24" x 36"	WR54-2436	64 lbs	AD54-2436	60 lbs	WR54-2436-5	77 lbs	AD54-2436-5	75 lbs	Y Y Y Y Y
24" x 42"	WR54-2442	72 lbs	AD54-2442	68 lbs	WR54-2442-5	87 lbs	AD54-2442-5	85 lbs	Y Y Y Y Y
24" x 48"	WR54-2448	76 lbs	AD54-2448	72 lbs	WR54-2448-5	92 lbs	AD54-2448-5	90 lbs	Y Y Y Y Y
24" x 54"	WR54-2454	84 lbs	AD54-2454	80 lbs	WR54-2454-5	102 lbs	AD54-2454-5	100 lbs	Y Y Y Y Y
24" x 60"	WR54-2460	96 lbs	AD54-2460	92 lbs	WR54-2460-5	117 lbs	AD54-2460-5	115 lbs	Y Y Y Y Y
24" x 72"	WR54-2472	116 lbs	AD54-2472	112 lbs	WR54-2472-5	142 lbs	AD54-2472-5	142 lbs	Y Y Y Y Y
30" x 36"	WR54-3036	72 lbs	AD54-3036	68 lbs	WR54-3036-5	87 lbs	AD54-3036-5	85 lbs	Y Y Y Y Y
30" x 42"	WR54-3042	84 lbs	AD54-3042	80 lbs	WR54-3042-5	102 lbs	AD54-3042-5	100 lbs	Y Y Y Y Y
30" x 48"	WR54-3048	96 lbs	AD54-3048	92 lbs	WR54-3048-5	117 lbs	AD54-3048-5	115 lbs	Y Y Y Y Y
30" x 60"	WR54-3060	120 lbs	AD54-3060	116 lbs	WR54-3060-5	147 lbs	AD54-3060-5	145 lbs	Y Y Y Y Y
30" x 72"	WR54-3072	136 lbs	AD54-3072	132 lbs	WR54-3072-5	167 lbs	AD54-3072-5	165 lbs	Y Y Y Y Y
36" x 36"	WR54-3636	84 lbs	AD54-3636	80 lbs	WR54-3636-5	102 lbs	AD54-3636-5	100 lbs	Y Y Y Y Y
36" x 48"	WR54-3648	104 lbs	AD54-3648	100 lbs	WR54-3648-5	127 lbs	AD54-3648-5	125 lbs	Y Y Y Y Y
36" x 60"	WR54-3660	128 lbs	AD54-3660	124 lbs	WR54-3660-5	157 lbs	AD54-3660-5	155 lbs	Y Y Y Y Y
36" x 72"	WR54-3672	136 lbs	AD54-3672	132 lbs	WR54-3672-5	171 lbs	AD54-3672-5	169 lbs	Y Y Y Y Y

Shelving units include 4 posts and 4 or 5 shelves. Add-on units include 2 posts, 4 or 5 shelves and 8 or 10 S-Hooks.

Y (Yes) N (No)





Add-On Kits



Additional Add-On kits allow you to expand your Starter kit by sharing a middle set of posts. Configuration options include side to side, back to back and right angles (L-Shape). Add-On kits come complete with 2 posts, 4 or 5 shelves and 8 or 10 S-Hooks. Additional shelves and posts may be purchased separately. See chart on pg. 24. Units with Add-On kits cannot be made mobile. **Finishes:** Chrome, Stainless Steel, Proform Green, Gray and Black Epoxy

Up to 600-800 lb.
LOAD CAPACITY PER SHELF

TO CHOOSE FINISH ADD FINISH SUFFIX TO MODEL NO.

Ex: **Chrome** WR63-1236C
Stainless WR63-1236S
Proform Green WR63-1236P
Gray WR63-1236GY
Black WR63-1236BK

Ex: **Chrome** WR63-1236C-5
Stainless WR63-1236S-5
Proform Green WR63-1236P-5
Gray WR63-1236GY-5
Black WR63-1236BK-5

Chrome
Stainless
Proform Green
GY Gray
BK Black

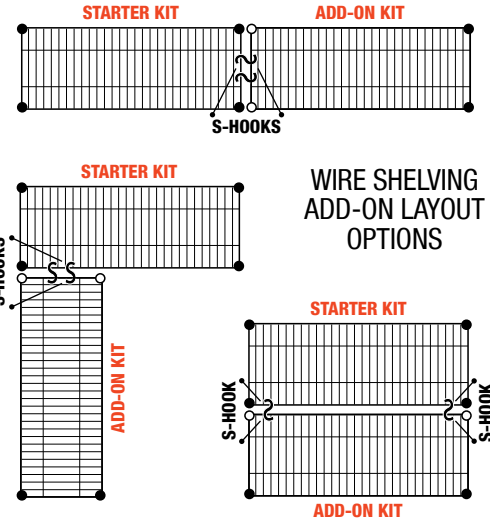

WIRE SHELVING ADD-ON LAYOUT OPTIONS

SHELF W" x L"	63"H - WIRE SHELVING 4 SHELVES		63"H - WIRE SHELVING 5 SHELVES		63"H - WIRE SHELVING 4 SHELVES		63"H - WIRE SHELVING 5 SHELVES		AVAILABLE FINISHES	
	MODEL NO.	SHIP WGT	MODEL NO.	SHIP WGT	MODEL NO.	SHIP WGT	MODEL NO.	SHIP WGT	C	S P GY BK
12" x 36"	WR63-1236	42 lbs	AD63-1236	37 lbs	WR63-1236-5	49 lbs	AD63-1236-5	46 lbs	Y	Y Y Y Y Y
12" x 42"	WR63-1242	46 lbs	AD63-1242	41 lbs	WR63-1242-5	54 lbs	AD63-1242-5	51 lbs	Y	N Y Y Y Y
12" x 48"	WR63-1248	52 lbs	AD63-1248	43 lbs	WR63-1248-5	74 lbs	AD63-1248-5	56 lbs	Y	Y Y Y Y Y
12" x 60"	WR63-1260	60 lbs	AD63-1260	51 lbs	WR63-1260-5	61 lbs	AD63-1260-5	69 lbs	Y	Y Y Y Y Y
12" x 72"	WR63-1272	68 lbs	AD63-1272	59 lbs	WR63-1272-5	85 lbs	AD63-1272-5	80 lbs	Y	Y Y Y Y Y
14" x 24"	WR63-1424	40 lbs	AD63-1424	31 lbs	WR63-1424-5	46 lbs	AD63-1424-5	41 lbs	Y	N Y Y Y Y
14" x 30"	WR63-1430	44 lbs	AD63-1430	35 lbs	WR63-1430-5	51 lbs	AD63-1430-5	46 lbs	Y	Y Y Y Y Y
14" x 36"	WR63-1436	48 lbs	AD63-1436	39 lbs	WR63-1436-5	56 lbs	AD63-1436-5	51 lbs	Y	Y Y Y Y Y
14" x 42"	WR63-1442	56 lbs	AD63-1442	47 lbs	WR63-1442-5	66 lbs	AD63-1442-5	61 lbs	Y	Y Y Y Y Y
14" x 48"	WR63-1448	60 lbs	AD63-1448	51 lbs	WR63-1448-5	71 lbs	AD63-1448-5	66 lbs	Y	Y Y Y Y Y
14" x 54"	WR63-1454	64 lbs	AD63-1454	55 lbs	WR63-1454-5	76 lbs	AD63-1454-5	71 lbs	Y	Y Y Y Y Y
14" x 60"	WR63-1460	72 lbs	AD63-1460	63 lbs	WR63-1460-5	86 lbs	AD63-1460-5	81 lbs	Y	Y Y Y Y Y
14" x 72"	WR63-1472	84 lbs	AD63-1472	75 lbs	WR63-1472-5	101 lbs	AD63-1472-5	96 lbs	Y	Y Y Y Y Y
18" x 24"	WR63-1824	44 lbs	AD63-1824	35 lbs	WR63-1824-5	51 lbs	AD63-1824-5	46 lbs	Y	Y Y Y Y Y
18" x 30"	WR63-1830	48 lbs	AD63-1830	39 lbs	WR63-1830-5	56 lbs	AD63-1830-5	51 lbs	Y	Y Y Y Y Y
18" x 36"	WR63-1836	54 lbs	AD63-1836	49 lbs	WR63-1836-5	64 lbs	AD63-1836-5	61 lbs	Y	Y Y Y Y Y
18" x 42"	WR63-1842	58 lbs	AD63-1842	53 lbs	WR63-1842-5	69 lbs	AD63-1842-5	66 lbs	Y	Y Y Y Y Y
18" x 48"	WR63-1848	62 lbs	AD63-1848	57 lbs	WR63-1848-5	76 lbs	AD63-1848-5	73 lbs	Y	Y Y Y Y Y
18" x 54"	WR63-1854	74 lbs	AD63-1854	69 lbs	WR63-1854-5	89 lbs	AD63-1854-5	86 lbs	Y	Y Y Y Y Y
18" x 60"	WR63-1860	82 lbs	AD63-1860	77 lbs	WR63-1860-5	99 lbs	AD63-1860-5	96 lbs	Y	Y Y Y Y Y
18" x 72"	WR63-1872	94 lbs	AD63-1872	89 lbs	WR63-1872-5	114 lbs	AD63-1872-5	111 lbs	Y	Y Y Y Y Y
21" x 24"	WR63-2124	46 lbs	AD63-2124	41 lbs	WR63-2124-5	54 lbs	AD63-2124-5	51 lbs	Y	Y Y Y Y Y
21" x 30"	WR63-2130	50 lbs	AD63-2130	45 lbs	WR63-2130-5	59 lbs	AD63-2130-5	56 lbs	Y	Y Y Y Y Y
21" x 36"	WR63-2136	58 lbs	AD63-2136	53 lbs	WR63-2136-5	69 lbs	AD63-2136-5	66 lbs	Y	Y Y Y Y Y
21" x 42"	WR63-2142	62 lbs	AD63-2142	57 lbs	WR63-2142-5	74 lbs	AD63-2142-5	71 lbs	Y	Y Y Y Y Y
21" x 48"	WR63-2148	70 lbs	AD63-2148	65 lbs	WR63-2148-5	84 lbs	AD63-2148-5	81 lbs	Y	Y Y Y Y Y
21" x 54"	WR63-2154	78 lbs	AD63-2154	73 lbs	WR63-2154-5	94 lbs	AD63-2154-5	91 lbs	Y	Y Y Y Y Y
21" x 60"	WR63-2160	86 lbs	AD63-2160	81 lbs	WR63-2160-5	104 lbs	AD63-2160-5	101 lbs	Y	Y Y Y Y Y
21" x 72"	WR63-2172	110 lbs	AD63-2172	105 lbs	WR63-2172-5	134 lbs	AD63-2172-5	131 lbs	Y	Y Y Y Y Y
24" x 24"	WR63-2424	50 lbs	AD63-2424	45 lbs	WR63-2424-5	59 lbs	AD63-2424-5	56 lbs	Y	Y Y Y Y Y
24" x 30"	WR63-2430	58 lbs	AD63-2430	53 lbs	WR63-2430-5	69 lbs	AD63-2430-5	66 lbs	Y	Y Y Y Y Y
24" x 36"	WR63-2436	66 lbs	AD63-2436	61 lbs	WR63-2436-5	79 lbs	AD63-2436-5	76 lbs	Y	Y Y Y Y Y
24" x 42"	WR63-2442	74 lbs	AD63-2442	69 lbs	WR63-2442-5	89 lbs	AD63-2442-5	86 lbs	Y	Y Y Y Y Y
24" x 48"	WR63-2448	78 lbs	AD63-2448	73 lbs	WR63-2448-5	94 lbs	AD63-2448-5	91 lbs	Y	Y Y Y Y Y
24" x 54"	WR63-2454	86 lbs	AD63-2454	81 lbs	WR63-2454-5	104 lbs	AD63-2454-5	101 lbs	Y	Y Y Y Y Y
24" x 60"	WR63-2460	98 lbs	AD63-2460	93 lbs	WR63-2460-5	119 lbs	AD63-2460-5	116 lbs	Y	Y Y Y Y Y
24" x 72"	WR63-2472	118 lbs	AD63-2472	113 lbs	WR63-2472-5	144 lbs	AD63-2472-5	141 lbs	Y	Y Y Y Y Y
30" x 36"	WR63-3036	74 lbs	AD63-3036	69 lbs	WR63-3036-5	89 lbs	AD63-3036-5	86 lbs	Y	Y Y Y Y Y
30" x 42"	WR63-3042	86 lbs	AD63-3042	81 lbs	WR63-3042-5	104 lbs	AD63-3042-5	101 lbs	Y	Y Y Y Y Y
30" x 48"	WR63-3048	98 lbs	AD63-3048	93 lbs	WR63-3048-5	119 lbs	AD63-3048-5	116 lbs	Y	Y Y Y Y Y
30" x 60"	WR63-3060	122 lbs	AD63-3060	117 lbs	WR63-3060-5	149 lbs	AD63-3060-5	146 lbs	Y	Y Y Y Y Y
30" x 72"	WR63-3072	138 lbs	AD63-3072	133 lbs	WR63-3072-5	169 lbs	AD63-3072-5	166 lbs	Y	Y Y Y Y Y
36" x 36"	WR63-3636	86 lbs	AD63-3636	81 lbs	WR63-3636-5	104 lbs	AD63-3636-5	101 lbs	Y	Y Y Y Y Y
36" x 48"	WR63-3648	106 lbs	AD63-3648	101 lbs	WR63-3648-5	129 lbs	AD63-3648-5	126 lbs	Y	Y Y Y Y Y
36" x 60"	WR63-3660	130 lbs	AD63-3660	125 lbs	WR63-3660-5	159 lbs	AD63-3660-5	156 lbs	Y	Y Y Y Y Y
36" x 72"	WR63-3672	138 lbs	AD63-3672	133 lbs	WR63-3672-5	173 lbs	AD63-3672-5	170 lbs	Y	Y Y Y Y Y

S-HOOK
For continuous runs of shelving. Two hooks should be placed per shelf where two posts are not utilized. For available finishes, see pg. 32

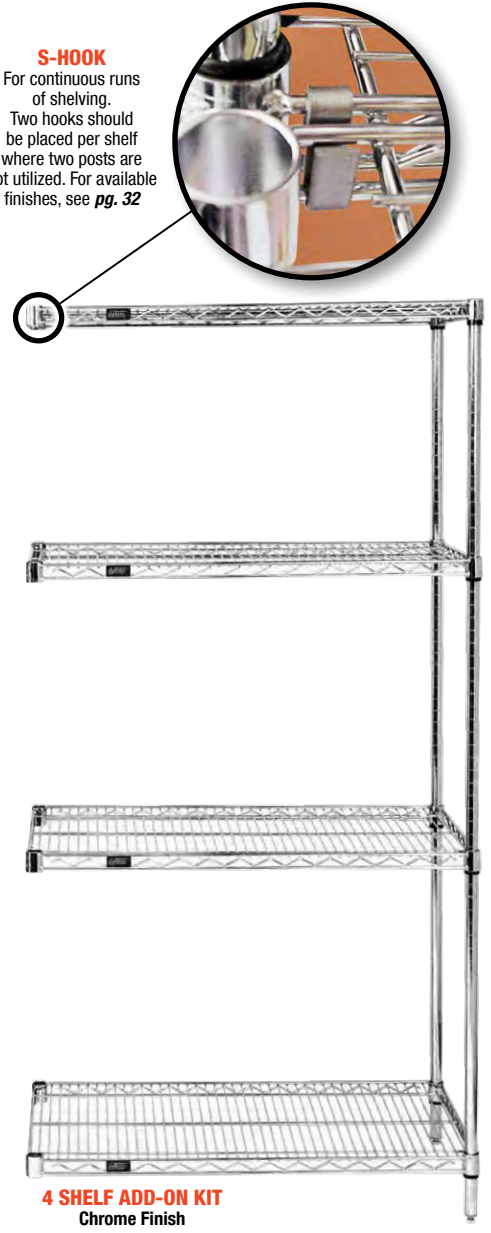

4 SHELF ADD-ON KIT
Chrome Finish

Shelving units include 4 posts and 4 or 5 shelves. Add-On units include 2 posts, 4 or 5 shelves and 8 or 10 S-Hooks. Y (Yes) N (No)
For easy installation, 63", 74" and 86" posts are available with pre-inserted leveler and bolt by adding an X to the Model No. WR63-1236X, WR63-1236-5X.



STORAGE

WIRE SHELVING - 74" UNITS STARTER AND ADD-ON KITS

Starter Kits



Heavy-duty shelving units allow up to 800 lb. shelf capacity. Starter kits come complete with 4 posts and 4 or 5 shelves. Additional shelves may be purchased separately. See chart on **pg. 24**. Mobilize starter kit shelving unit using optional mobile kit, **WR-00H**, see **pg. 33**. **Finishes:** Chrome, Stainless Steel, Proform Green, Gray and Black Epoxy

Up to 600-800 lb.
LOAD CAPACITY PER SHELF

TO CHOOSE FINISH ADD FINISH SUFFIX TO MODEL NO.

Ex: **Chrome** WR74-1236C
Stainless WR74-1236S
Proform Green WR74-1236P
Gray WR74-1236GY
Black WR74-1236BK

Ex: **Chrome** WR74-1236C-5
Stainless WR74-1236S-5
Proform Green WR74-1236P-5
Gray WR74-1236GY-5
Black WR74-1236BK-5

Chrome
Stainless
Proform Green
GY Gray
BK Black



MOBILIZE YOUR WIRE SHELVING

DB - Donut Bumper
Non-marking donut bumper used to protect walls and help cushion impact.

WR-00H (Mobile Kit)*
Set of four swivel thermoplastic resin 5" x 1-1/4" casters, two with brakes. Can be used with all units shown. 1,200 lb. load capacity. *Mobile kits recommended only for shelves 18" and deeper.



4 SHELF STARTER KIT
Proform Green Epoxy Finish



5 SHELF STARTER KIT
Black Epoxy Finish

SHELF W" x L"	74"H - WIRE SHELVING 4 SHELVES				74"H - WIRE SHELVING 5 SHELVES				AVAILABLE FINISHES				
	MODEL NO.	SHIP WGT	MODEL NO.	SHIP WGT	MODEL NO.	SHIP WGT	MODEL NO.	SHIP WGT	C	S	P	GY	BK
12" x 36"	WR74-1236	44 lbs	AD74-1236	38 lbs	WR74-1236-5	51 lbs	AD74-1236-5	47 lbs	Y	Y	Y	Y	Y
12" x 42"	WR74-1242	48 lbs	AD74-1242	42 lbs	WR74-1242-5	56 lbs	AD74-1242-5	52 lbs	Y	N	Y	Y	Y
12" x 48"	WR74-1248	52 lbs	AD74-1248	46 lbs	WR74-1248-5	61 lbs	AD74-1248-5	57 lbs	Y	Y	Y	Y	Y
12" x 60"	WR74-1260	60 lbs	AD74-1260	54 lbs	WR74-1260-5	74 lbs	AD74-1260-5	70 lbs	Y	Y	Y	Y	Y
12" x 72"	WR74-1272	68 lbs	AD74-1272	62 lbs	WR74-1272-5	85 lbs	AD74-1272-5	81 lbs	Y	Y	Y	Y	Y
14" x 24"	WR74-1424	40 lbs	AD74-1424	34 lbs	WR74-1424-5	46 lbs	AD74-1424-5	42 lbs	Y	N	Y	Y	Y
14" x 30"	WR74-1430	44 lbs	AD74-1430	38 lbs	WR74-1430-5	51 lbs	AD74-1430-5	47 lbs	Y	Y	Y	Y	Y
14" x 36"	WR74-1436	48 lbs	AD74-1436	42 lbs	WR74-1436-5	56 lbs	AD74-1436-5	52 lbs	Y	Y	Y	Y	Y
14" x 42"	WR74-1442	56 lbs	AD74-1442	50 lbs	WR74-1442-5	66 lbs	AD74-1442-5	62 lbs	Y	Y	Y	Y	Y
14" x 48"	WR74-1448	60 lbs	AD74-1448	54 lbs	WR74-1448-5	71 lbs	AD74-1448-5	67 lbs	Y	Y	Y	Y	Y
14" x 54"	WR74-1454	64 lbs	AD74-1454	58 lbs	WR74-1454-5	76 lbs	AD74-1454-5	72 lbs	Y	Y	Y	Y	Y
14" x 60"	WR74-1460	72 lbs	AD74-1460	66 lbs	WR74-1460-5	86 lbs	AD74-1460-5	82 lbs	Y	Y	Y	Y	Y
14" x 72"	WR74-1472	84 lbs	AD74-1472	78 lbs	WR74-1472-5	101 lbs	AD74-1472-5	97 lbs	Y	Y	Y	Y	Y
18" x 24"	WR74-1824	44 lbs	AD74-1824	38 lbs	WR74-1824-5	51 lbs	AD74-1824-5	47 lbs	Y	Y	Y	Y	Y
18" x 30"	WR74-1830	48 lbs	AD74-1830	42 lbs	WR74-1830-5	56 lbs	AD74-1830-5	52 lbs	Y	Y	Y	Y	Y
18" x 36"	WR74-1836	56 lbs	AD74-1836	50 lbs	WR74-1836-5	66 lbs	AD74-1836-5	62 lbs	Y	Y	Y	Y	Y
18" x 42"	WR74-1842	60 lbs	AD74-1842	54 lbs	WR74-1842-5	71 lbs	AD74-1842-5	67 lbs	Y	Y	Y	Y	Y
18" x 48"	WR74-1848	64 lbs	AD74-1848	58 lbs	WR74-1848-5	78 lbs	AD74-1848-5	74 lbs	Y	Y	Y	Y	Y
18" x 54"	WR74-1854	76 lbs	AD74-1854	70 lbs	WR74-1854-5	91 lbs	AD74-1854-5	87 lbs	Y	Y	Y	Y	Y
18" x 60"	WR74-1860	84 lbs	AD74-1860	78 lbs	WR74-1860-5	101 lbs	AD74-1860-5	97 lbs	Y	Y	Y	Y	Y
18" x 72"	WR74-1872	96 lbs	AD74-1872	90 lbs	WR74-1872-5	116 lbs	AD74-1872-5	112 lbs	Y	Y	Y	Y	Y
21" x 24"	WR74-2124	48 lbs	AD74-2124	42 lbs	WR74-2124-5	56 lbs	AD74-2124-5	52 lbs	Y	Y	Y	Y	Y
21" x 30"	WR74-2130	52 lbs	AD74-2130	46 lbs	WR74-2130-5	61 lbs	AD74-2130-5	57 lbs	Y	Y	Y	Y	Y
21" x 36"	WR74-2136	60 lbs	AD74-2136	54 lbs	WR74-2136-5	71 lbs	AD74-2136-5	67 lbs	Y	Y	Y	Y	Y
21" x 42"	WR74-2142	64 lbs	AD74-2142	58 lbs	WR74-2142-5	76 lbs	AD74-2142-5	72 lbs	Y	Y	Y	Y	Y
21" x 48"	WR74-2148	72 lbs	AD74-2148	66 lbs	WR74-2148-5	86 lbs	AD74-2148-5	82 lbs	Y	Y	Y	Y	Y
21" x 54"	WR74-2154	80 lbs	AD74-2154	74 lbs	WR74-2154-5	96 lbs	AD74-2154-5	92 lbs	Y	Y	Y	Y	Y
21" x 60"	WR74-2160	88 lbs	AD74-2160	82 lbs	WR74-2160-5	106 lbs	AD74-2160-5	102 lbs	Y	Y	Y	Y	Y
21" x 72"	WR74-2172	112 lbs	AD74-2172	106 lbs	WR74-2172-5	136 lbs	AD74-2172-5	132 lbs	Y	Y	Y	Y	Y
24" x 24"	WR74-2424	52 lbs	AD74-2424	46 lbs	WR74-2424-5	61 lbs	AD74-2424-5	57 lbs	Y	Y	Y	Y	Y
24" x 30"	WR74-2430	60 lbs	AD74-2430	54 lbs	WR74-2430-5	71 lbs	AD74-2430-5	67 lbs	Y	Y	Y	Y	Y
24" x 36"	WR74-2436	68 lbs	AD74-2436	62 lbs	WR74-2436-5	81 lbs	AD74-2436-5	77 lbs	Y	Y	Y	Y	Y
24" x 42"	WR74-2442	76 lbs	AD74-2442	70 lbs	WR74-2442-5	91 lbs	AD74-2442-5	87 lbs	Y	Y	Y	Y	Y
24" x 48"	WR74-2448	80 lbs	AD74-2448	74 lbs	WR74-2448-5	96 lbs	AD74-2448-5	92 lbs	Y	Y	Y	Y	Y
24" x 54"	WR74-2454	88 lbs	AD74-2454	82 lbs	WR74-2454-5	106 lbs	AD74-2454-5	102 lbs	Y	Y	Y	Y	Y
24" x 60"	WR74-2460	100 lbs	AD74-2460	94 lbs	WR74-2460-5	121 lbs	AD74-2460-5	117 lbs	Y	Y	Y	Y	Y
24" x 72"	WR74-2472	120 lbs	AD74-2472	114 lbs	WR74-2472-5	146 lbs	AD74-2472-5	142 lbs	Y	Y	Y	Y	Y
30" x 36"	WR74-3036	76 lbs	AD74-3036	70 lbs	WR74-3036-5	91 lbs	AD74-3036-5	87 lbs	Y	Y	Y	Y	Y
30" x 42"	WR74-3042	88 lbs	AD74-3042	82 lbs	WR74-3042-5	106 lbs	AD74-3042-5	102 lbs	Y	Y	Y	Y	Y
30" x 48"	WR74-3048	100 lbs	AD74-3048	94 lbs	WR74-3048-5	121 lbs	AD74-3048-5	117 lbs	Y	Y	Y	Y	Y
30" x 60"	WR74-3060	124 lbs	AD74-3060	118 lbs	WR74-3060-5	151 lbs	AD74-3060-5	147 lbs	Y	Y	Y	Y	Y
30" x 72"	WR74-3072	140 lbs	AD74-3072	134 lbs	WR74-3072-5	171 lbs	AD74-3072-5	167 lbs	Y	Y	Y	Y	Y
36" x 36"	WR74-3636	88 lbs	AD74-3636	82 lbs	WR74-3636-5	106 lbs	AD74-3636-5	102 lbs	Y	Y	Y	Y	Y
36" x 48"	WR74-3648	108 lbs	AD74-3648	102 lbs	WR74-3648-5	131 lbs	AD74-3648-5	127 lbs	Y	Y	Y	Y	Y
36" x 60"	WR74-3660	132 lbs	AD74-3660	126 lbs	WR74-3660-5	161 lbs	AD74-3660-5	157 lbs	Y	Y	Y	Y	Y
36" x 72"	WR74-3672	140 lbs	AD74-3672	134 lbs	WR74-3672-5	175 lbs	AD74-3672-5	171 lbs	Y	Y	Y	Y	Y

Shelving units include 4 posts and 4 or 5 shelves. Add-On units include 2 posts, 4 or 5 shelves and 8 or 10 S-Hooks. Y (Yes) N (No)
For easy installation, 63", 74" and 86" posts are available with pre-inserted leveler and bolt by adding an X to the Model No. WR74-1236X, WR74-1236-5X.



Add-On Kits



Additional Add-On kits allow you to expand your Starter kit by sharing a set of posts. Configuration options include side to side, back to back and right angles (L-Shape). Add-On kits come complete with 2 posts, 4 or 5 shelves and 8 or 10 S-Hooks. Additional shelves and posts may be purchased separately. See chart on pg. 24. Units with Add-On kit cannot be made mobile. **Finishes:** Chrome, Stainless Steel, Proform Green, Gray and Black Epoxy

Up to 600-800 lb.
LOAD CAPACITY PER SHELF

TO CHOOSE FINISH ADD FINISH SUFFIX TO MODEL NO.

Ex: **Chrome** WR86-1236C
Stainless WR86-1236S
Proform Green WR86-1236P
Gray WR86-1236GY
Black WR86-1236BK

Ex: **Chrome** WR86-1236C-5
Stainless WR86-1236S-5
Proform Green WR86-1236P-5
Gray WR86-1236GY-5
Black WR86-1236BK-5

Chrome
Stainless
Proform Green
GY Gray
BK Black

SHELF W" x L"	86"H - WIRE SHELVING 4 SHELVES				86"H - WIRE SHELVING 5 SHELVES				AVAILABLE	
	STARTER KIT	ADD-ON KIT	STARTER KIT	ADD-ON KIT	STARTER KIT	ADD-ON KIT	STARTER KIT	ADD-ON KIT	C	S P GY BK
12" x 36"	WR86-1236	48 lbs	AD86-1236	40 lbs	WR86-1236-5	55 lbs	AD86-1236-5	49 lbs	Y	Y Y Y Y Y
12" x 42"	WR86-1242	52 lbs	AD86-1242	44 lbs	WR86-1242-5	60 lbs	AD86-1242-5	54 lbs	Y	N Y Y Y Y
12" x 48"	WR86-1248	56 lbs	AD86-1248	48 lbs	WR86-1248-5	65 lbs	AD86-1248-5	59 lbs	Y	Y Y Y Y Y
12" x 60"	WR86-1260	64 lbs	AD86-1260	56 lbs	WR86-1260-5	78 lbs	AD86-1260-5	72 lbs	Y	Y Y Y Y Y
12" x 72"	WR86-1272	72 lbs	AD86-1272	64 lbs	WR86-1272-5	89 lbs	AD86-1272-5	83 lbs	Y	Y Y Y Y Y
14" x 24"	WR86-1424	44 lbs	AD86-1424	36 lbs	WR86-1424-5	50 lbs	AD86-1424-5	44 lbs	Y	N Y Y Y Y
14" x 30"	WR86-1430	48 lbs	AD86-1430	40 lbs	WR86-1430-5	55 lbs	AD86-1430-5	49 lbs	Y	Y Y Y Y Y
14" x 36"	WR86-1436	52 lbs	AD86-1436	44 lbs	WR86-1436-5	60 lbs	AD86-1436-5	54 lbs	Y	Y Y Y Y Y
14" x 42"	WR86-1442	60 lbs	AD86-1442	52 lbs	WR86-1442-5	70 lbs	AD86-1442-5	64 lbs	Y	Y Y Y Y Y
14" x 48"	WR86-1448	64 lbs	AD86-1448	56 lbs	WR86-1448-5	75 lbs	AD86-1448-5	69 lbs	Y	Y Y Y Y Y
14" x 54"	WR86-1454	68 lbs	AD86-1454	60 lbs	WR86-1454-5	80 lbs	AD86-1454-5	74 lbs	Y	Y Y Y Y Y
14" x 60"	WR86-1460	76 lbs	AD86-1460	68 lbs	WR86-1460-5	90 lbs	AD86-1460-5	84 lbs	Y	Y Y Y Y Y
14" x 72"	WR86-1472	88 lbs	AD86-1472	80 lbs	WR86-1472-5	105 lbs	AD86-1472-5	99 lbs	Y	Y Y Y Y Y
18" x 24"	WR86-1824	48 lbs	AD86-1824	40 lbs	WR86-1824-5	55 lbs	AD86-1824-5	49 lbs	Y	Y Y Y Y Y
18" x 30"	WR86-1830	52 lbs	AD86-1830	44 lbs	WR86-1830-5	60 lbs	AD86-1830-5	54 lbs	Y	Y Y Y Y Y
18" x 36"	WR86-1836	60 lbs	AD86-1836	52 lbs	WR86-1836-5	70 lbs	AD86-1836-5	64 lbs	Y	Y Y Y Y Y
18" x 42"	WR86-1842	64 lbs	AD86-1842	56 lbs	WR86-1842-5	65 lbs	AD86-1842-5	69 lbs	Y	Y Y Y Y Y
18" x 48"	WR86-1848	68 lbs	AD86-1848	60 lbs	WR86-1848-5	82 lbs	AD86-1848-5	76 lbs	Y	Y Y Y Y Y
18" x 54"	WR86-1854	80 lbs	AD86-1854	72 lbs	WR86-1854-5	95 lbs	AD86-1854-5	89 lbs	Y	Y Y Y Y Y
18" x 60"	WR86-1860	88 lbs	AD86-1860	80 lbs	WR86-1860-5	105 lbs	AD86-1860-5	99 lbs	Y	Y Y Y Y Y
18" x 72"	WR86-1872	100 lbs	AD86-1872	92 lbs	WR86-1872-5	120 lbs	AD86-1872-5	114 lbs	Y	Y Y Y Y Y
21" x 24"	WR86-2124	52 lbs	AD86-2124	44 lbs	WR86-2124-5	60 lbs	AD86-2124-5	54 lbs	Y	Y Y Y Y Y
21" x 30"	WR86-2130	56 lbs	AD86-2130	48 lbs	WR86-2130-5	65 lbs	AD86-2130-5	59 lbs	Y	Y Y Y Y Y
21" x 36"	WR86-2136	64 lbs	AD86-2136	56 lbs	WR86-2136-5	75 lbs	AD86-2136-5	69 lbs	Y	Y Y Y Y Y
21" x 42"	WR86-2142	68 lbs	AD86-2142	60 lbs	WR86-2142-5	80 lbs	AD86-2142-5	74 lbs	Y	Y Y Y Y Y
21" x 48"	WR86-2148	76 lbs	AD86-2148	68 lbs	WR86-2148-5	90 lbs	AD86-2148-5	84 lbs	Y	Y Y Y Y Y
21" x 54"	WR86-2154	84 lbs	AD86-2154	76 lbs	WR86-2154-5	100 lbs	AD86-2154-5	94 lbs	Y	Y Y Y Y Y
21" x 60"	WR86-2160	92 lbs	AD86-2160	84 lbs	WR86-2160-5	110 lbs	AD86-2160-5	104 lbs	Y	Y Y Y Y Y
21" x 72"	WR86-2172	116 lbs	AD86-2172	108 lbs	WR86-2172-5	140 lbs	AD86-2172-5	134 lbs	Y	Y Y Y Y Y
24" x 24"	WR86-2424	56 lbs	AD86-2424	48 lbs	WR86-2424-5	65 lbs	AD86-2424-5	59 lbs	Y	Y Y Y Y Y
24" x 30"	WR86-2430	64 lbs	AD86-2430	56 lbs	WR86-2430-5	75 lbs	AD86-2430-5	69 lbs	Y	Y Y Y Y Y
24" x 36"	WR86-2436	72 lbs	AD86-2436	64 lbs	WR86-2436-5	85 lbs	AD86-2436-5	79 lbs	Y	Y Y Y Y Y
24" x 42"	WR86-2442	80 lbs	AD86-2442	72 lbs	WR86-2442-5	95 lbs	AD86-2442-5	89 lbs	Y	Y Y Y Y Y
24" x 48"	WR86-2448	84 lbs	AD86-2448	76 lbs	WR86-2448-5	100 lbs	AD86-2448-5	94 lbs	Y	Y Y Y Y Y
24" x 54"	WR86-2454	92 lbs	AD86-2454	84 lbs	WR86-2454-5	110 lbs	AD86-2454-5	104 lbs	Y	Y Y Y Y Y
24" x 60"	WR86-2460	104 lbs	AD86-2460	96 lbs	WR86-2460-5	125 lbs	AD86-2460-5	119 lbs	Y	Y Y Y Y Y
24" x 72"	WR86-2472	124 lbs	AD86-2472	116 lbs	WR86-2472-5	150 lbs	AD86-2472-5	144 lbs	Y	Y Y Y Y Y
30" x 36"	WR86-3036	80 lbs	AD86-3036	72 lbs	WR86-3036-5	95 lbs	AD86-3036-5	89 lbs	Y	Y Y Y Y Y
30" x 42"	WR86-3042	92 lbs	AD86-3042	84 lbs	WR86-3042-5	110 lbs	AD86-3042-5	104 lbs	Y	Y Y Y Y Y
30" x 48"	WR86-3048	104 lbs	AD86-3048	96 lbs	WR86-3048-5	125 lbs	AD86-3048-5	119 lbs	Y	Y Y Y Y Y
30" x 60"	WR86-3060	128 lbs	AD86-3060	120 lbs	WR86-3060-5	155 lbs	AD86-3060-5	149 lbs	Y	Y Y Y Y Y
30" x 72"	WR86-3072	144 lbs	AD86-3072	136 lbs	WR86-3072-5	175 lbs	AD86-3072-5	169 lbs	Y	Y Y Y Y Y
36" x 36"	WR86-3636	92 lbs	AD86-3636	84 lbs	WR86-3636-5	110 lbs	AD86-3636-5	104 lbs	Y	Y Y Y Y Y
36" x 48"	WR86-3648	112 lbs	AD86-3648	104 lbs	WR86-3648-5	135 lbs	AD86-3648-5	129 lbs	Y	Y Y Y Y Y
36" x 60"	WR86-3660	136 lbs	AD86-3660	128 lbs	WR86-3660-5	165 lbs	AD86-3660-5	159 lbs	Y	Y Y Y Y Y
36" x 72"	WR86-3672	144 lbs	AD86-3672	136 lbs	WR86-3672-5	179 lbs	AD86-3672-5	173 lbs	Y	Y Y Y Y Y

Shelving units include 4 posts and 4 or 5 shelves. Add-on units include 2 posts, 4 or 5 shelves and 8 or 10 S-Hooks. Y (Yes) N (No)
For easy installation, 63", 74" and 86" posts are available with pre-inserted leveler and bolt by adding an X to the Model No. WR86-1236X, WR86-1236-5X.

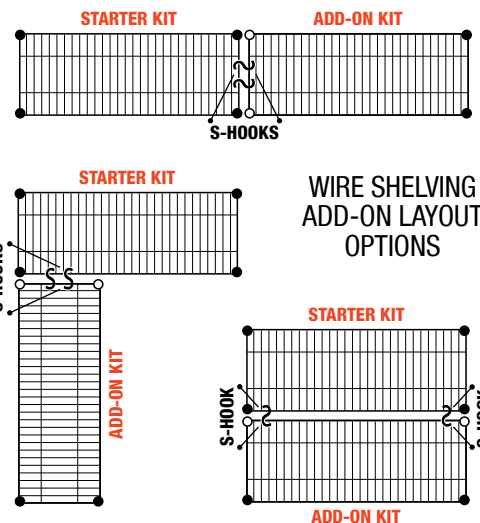

WIRE SHELVING ADD-ON LAYOUT OPTIONS

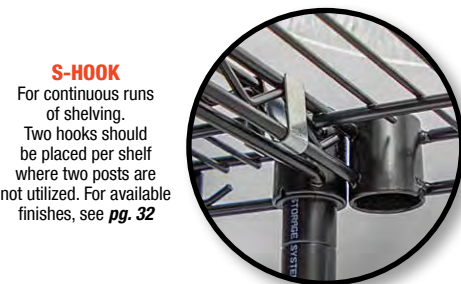

S-HOOK
For continuous runs of shelving. Two hooks should be placed per shelf where two posts are not utilized. For available finishes, see pg. 32





Modular Enclosure Panels

NEW FINISH

Are easily adaptable to standard shelving units to create a secured storage area.

- Panels are fabricated from 6 gauge wire on 3" x 3" squares
- Modular enclosure panels work with four shelf depths: 14", 18", 21" and 24" and three heights: 63", 74" and 86"
- One modular enclosure panel is needed for each side and two or three panels are needed for the back
- New **EP-CLIP** hardware package allows enclosure panels to be fastened tight to the shelves to help eliminate any rattling noise while in transit. One package needed per enclosure panel.

CHROME	STAINLESS STEEL	PROFORM GREEN EPOXY (NEW)	Add -CUT to Model No. for use with bottom solid shelf ▶ Ex. EP126-CUT
MODEL NO.	MODEL NO.	MODEL NO.	DESCRIPTION
EP126	EP126S	EP126P	One 12" x 62" Panel
EP166	EP166S	EP166P	One 16" x 62" Panel
EP196	EP196S	EP196P	One 19" x 62" Panel
EP226	EP226S	EP226P	One 22" x 62" Panel
EP127	EP127S	EP127P	One 12" x 73" Panel
EP167	EP167S	EP167P	One 16" x 73" Panel
EP197	EP197S	EP197P	One 19" x 73" Panel
EP227	EP227S	EP227P	One 22" x 73" Panel
EP128	EP128S	EP128P	One 12" x 84" Panel
EP168	EP168S	EP168P	One 16" x 84" Panel
EP198	EP198S	EP198P	One 19" x 84" Panel
EP228	EP228S	EP228P	One 22" x 84" Panel



MOBILE CART SHOWN WITH 4 ENCLOSURE PANELS. MOBILE ENCLOSURE CARTS AVAILABLE

See pg. 45

- Holds up to 25 lb. weight capacity evenly distributed



Hang Rails

CHROME	STAINLESS STEEL	DESCRIPTION	SHIP WGT
MODEL NO.	MODEL NO.		
HB14C	-	One 14" Hang Rail	2 lbs
HB18C	HB18S	One 18" Hang Rail	3 lbs
HB24C	HB24S	One 24" Hang Rail	4 lbs
HB36C	HB36S	One 36" Hang Rail	5 lbs
HB48C	HB48S	One 48" Hang Rail	6 lbs
HB60C	HB60S	One 60" Hang Rail	7 lbs

Hang Bars

- Holds up to 75 lbs. weight capacity evenly distributed

CHROME	STAINLESS STEEL	DESCRIPTION	SHIP WGT
MODEL NO.	MODEL NO.		
<i>Finishes: Chrome and Stainless Steel</i>			
Intermediate			
GR24	-	One 24" Chrome Hang Bar	2 lbs
Full Length			
GR36	GR36S	One 36" Hang Bar	3 lbs
GR48	GR48S	One 48" Hang Bar	4 lbs
GR60	GR60S	One 60" Hang Bar	5 lbs
-	GR72S	One 72" Stainless Steel Hang Bar	6 lbs



GR24



GR36, GR48, GR60

Single and Double Drawer Slides

Compliment any system with specialized areas for storage which allow bins and trays to be suspended between shelves. Single bin slide mounts 18", 21" and 24" shelves. Double bin slide adapts to 24" shelves only. (Bins sold separately) *Finish: Chrome*

MODEL NO.	DESCRIPTION	SHIP WGT
DS18-24	Single Bin Design	2 lbs
DDS-24	Double Bin Design	4 lbs



DS18-24

CHOOSE FROM ONE BIN/TRAY DESIGN OR TWO BIN/TRAY DESIGN

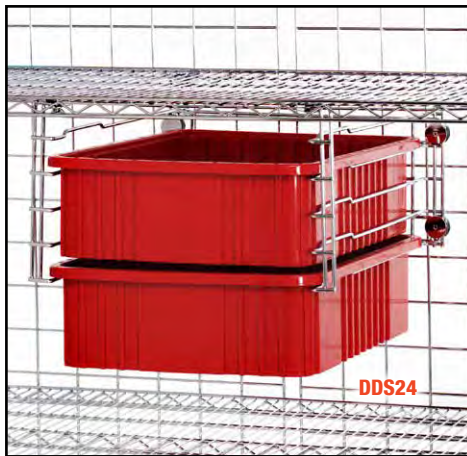

DDS24

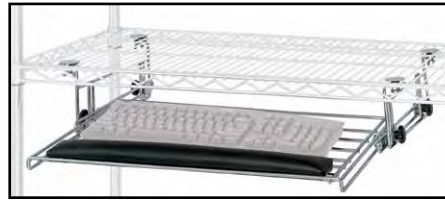

KEYBD

Keyboard Shelf

Mounts under any size wire shelf and accepts keyboards up to 21"W x 11"D. Has a 6" height adjustment. Measures 25-1/4"W x 15"D x 4-1/4"H

Finish: Chrome



Modular Dolly Frames

DB1836S-PT

Dolly Frames allow standard shelving units to be converted to heavy-duty transport trucks. Frames are fabricated from heavy gauge steel. Bumpers are attached to each corner to protect walls and help cushion impact. *Finishes: Chrome and Stainless Steel*

CHROME	STAINLESS STEEL	DIMENSIONS W" x L"	SHIP WGT
MODEL NO.	MODEL NO.		
Dolly Frame Only			
DB1836C	DB1836S	18" x 36"	10 lbs
DB1848C	DB1848S	18" x 48"	12 lbs
DB1860C	DB1860S	18" x 60"	14 lbs
DB2436C	DB2436S	24" x 36"	13 lbs
DB2448C	DB2448S	24" x 48"	15 lbs
DB2460C	DB2460S	24" x 60"	18 lbs
Dolly Kit - Includes 4 Swivel Plate Casters, 2 with Brake			
DB1836C-PT	DB1836S-PT	18" x 36"	22 lbs
DB1848C-PT	DB1848S-PT	18" x 48"	24 lbs
DB1860C-PT	DB1860S-PT	18" x 60"	26 lbs
DB2436C-PT	DB2436S-PT	24" x 36"	25 lbs
DB2448C-PT	DB2448S-PT	24" x 48"	27 lbs
DB2460C-PT	DB2460S-PT	24" x 60"	30 lbs



Side and Back Ledges

Ledges are 4"H and act as a perimeter to retain shelf items and prevent anything from falling off. To order a Proform Green, Gray or Black Epoxy finish, add **P**, **GY** or **BK** right after chrome model no. prefix (i.e. *SL12P*, *SL12GY* or *SL12BK*). **Finishes:** Chrome, Stainless Steel, Proform Green, Gray and Black Epoxy

CHROME	STAINLESS STEEL	AVAILABLE EPOXY			DESCRIPTION	SHIP WGT
MODEL NO.	MODEL NO.	P	GY	BK		
4"H - Side Ledges						
SL12	SL12S	Y	Y	Y	12" Side Ledge	1 lb
SL14	SL14S	Y	Y	Y	14" Side Ledge	1 lb
SL18	SL18S	Y	Y	Y	18" Side Ledge	1 lb
SL21	SL21S	Y	Y	Y	21" Side Ledge	2 lbs
SL24	SL24S	Y	Y	Y	24" Side Ledge	2 lbs
SL30	SL30S	Y	Y	Y	30" Side/Back Ledge	2 lbs
4"H - Back Ledges						
BL36	BL36S	Y	Y	Y	36" Back/Side Ledge	3 lbs
BL42	BL42S	Y	Y	Y	42" Back Ledge	3 lbs
BL48	BL48S	Y	Y	Y	48" Back Ledge	3 lbs
BL54	BL54S	Y	Y	Y	54" Back Ledge	4 lbs
BL60	BL60S	Y	Y	Y	60" Back Ledge	5 lbs
BL72	BL72S	Y	Y	Y	72" Back Ledge	6 lbs

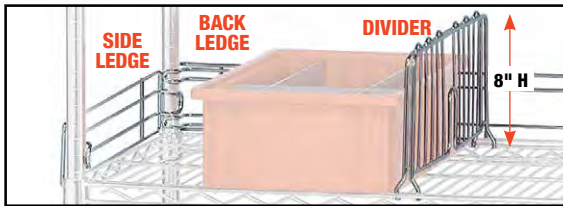

Dividers

NEW SIZES

Dividers are 8"H unless specified and are available in 7 depths to be used with all shelves. To order a Proform Green, Gray or Black Epoxy finish, add **P**, **GY** or **BK** right after chrome model no. prefix (i.e. *DIV12P*, *DIV12GY* or *DIV12BK*). **Finishes:** Chrome, Stainless Steel, Proform Green, Gray and Black Epoxy

CHROME	STAINLESS STEEL	AVAILABLE EPOXY			DESCRIPTION	SHIP WGT
MODEL NO.	MODEL NO.	P	GY	BK		
Dividers						
DIV12	DIV12S	Y	Y	Y	One 12" Divider	2 lbs
DIV14	DIV14S	Y	Y	Y	One 14" Divider	2 lbs
DIV18	DIV18S	Y	Y	Y	One 18" Divider	2 lbs
DIV21	DIV21S	Y	Y	Y	One 21" Divider	3 lbs
DIV24	DIV24S	Y	Y	Y	One 24" Divider	3 lbs
NEW DIV24X3SW**	-	N	N	N	One 24" x 3.61" Divider	1 lb
NEW DIV24X6	-	N	N	N	One 24" x 6" Divider	1 lb
NEW DIV24X21*	-	N	Y	N	One 24" x 21" Divider	5 lbs
DIV30	DIV30S	Y	Y	Y	One 30" Divider	4 lbs
DIV36	DIV36S	Y	Y	Y	One 36" Divider	4 lbs

*Only available in Gray Epoxy finish
**Single wire design

Wire Carton Dividers

Quantum's new wire carton dividers are the ideal storage tool to maintain and organize your boxes. Available for 18" and 24" shelf depths, the dividers fix in place and provide firm and convenient storage to your warehouse and workplace. Two convenient heights to choose from: 14" or 20-1/2". **Finish:** Chrome

MODEL NO.	DESCRIPTION	SHIP WGT
WCSD-1814	18" x 14" Divider	3 lbs
WCSD-1820	18" x 20-1/2" Divider	3 lbs
WCSD-2414	24" x 14" Divider	3 lbs
WCSD-2420	24" x 20-1/2" Divider	4 lbs

Push Handles

Comfortable grip design. Five widths available enabling easy movement of any mobile unit. To order a Proform Green, Gray or Black Epoxy finish, add **P**, **GY** or **BK** right after chrome model no. prefix (i.e. *PH18P*, *PH18GY* or *PH18BK*). **Finishes:** Chrome, Stainless Steel, Proform Green, Gray and Black Epoxy

CHROME	STAINLESS STEEL	AVAILABLE EPOXY			DESCRIPTION	SHIP WGT
MODEL NO.	MODEL NO.	P	GY	BK		
PH18	PH18S	Y	Y	Y	One 18" Push Handle	2 lbs
PH21	PH21S	Y	Y	N	One 21" Push Handle	3 lbs
PH24	PH24S	Y	Y	Y	One 24" Push Handle	3 lbs
PH30	-	N	N	N	One 30" Push Handle	3 lbs
PH36	PH36S	N	N	N	One 36" Push Handle	3 lbs



PH18

U-Handles

Build your own special size utility cart with three different width choices: 18", 21" or 24". Overall height 32", not including casters. To order a Proform Green, Gray or Black Epoxy finish, add **P**, **GY** or **BK** right after chrome model no. prefix (i.e. *UH18P*, *UH18GY* or *UH18BK*). **Finishes:** Chrome, Stainless Steel, Proform Green, Gray and Black Epoxy

CHROME	STAINLESS STEEL	AVAILABLE EPOXY			DESCRIPTION	SHIP WGT
MODEL NO.	MODEL NO.	P	GY	BK		
UH18	UH18S	Y	Y	Y	18" U-Handle	2 lbs
UH21	UH21S	Y	Y	N	21" U-Handle	3 lbs
UH24	UH24S	Y	Y	Y	24" U-Handle	3 lbs



UH18

Tie Bars

Required with rigid casters to ensure rigid alignment. Tie bar length should match up to shelf depth. Rigid casters sold separately. **Finish:** Chrome

MODEL NO.	DESCRIPTION	SHIP WGT
18TB	One 18" Tie Bar which Fits 2 Casters	2 lbs
21TB	One 21" Tie Bar which Fits 2 Casters	2 lbs
24TB	One 24" Tie Bar which Fits 2 Casters	2 lbs
30TB	One 30" Tie Bar which Fits 2 Casters	2 lbs
36TB	One 36" Tie Bar which Fits 2 Casters	3 lbs



18TB

Post Clamps

Joins multiple units of shelving. **Finish:** Chrome

MODEL NO.	DESCRIPTION	SHIP WGT
PCL1	1/2" Post Clamp	1 lb
PCL2	3-1/3" Post Clamp	1 lb



PCL2



WCSD-1820



S-HOOK
Chrome



S-HOOKSS
Stainless Steel



S-HOOKP
Proform Green
Epoxy



S-HOOKGY
Gray Epoxy



S-HOOKBK
Black Epoxy

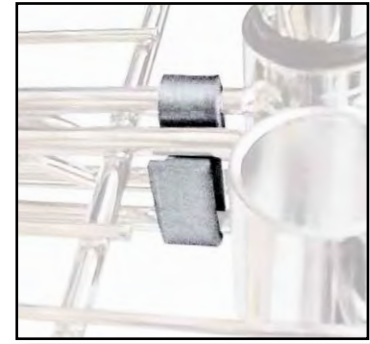

S-Hooks

For continuous runs of shelving. Two hooks should be used per shelf where two posts are not utilized. Sold as an 8 pack. **Finishes:** Chrome, Stainless Steel, Proform Green, Gray and Black Epoxy

Seismic Foot Plates

Quantum's seismic foot plates are used to anchor stationary shelving units to the floor.

MODEL NO.	DESCRIPTION	SHIP WGT
WR-SFP	Single Seismic Foot Plate	3 lbs
WR-DFP	Double Seismic Foot Plate	4 lbs



SCH1-5



SCH1

Collar Hooks

Used to secure baskets to posts or as a hook for longer items. Sold in packs of four.

MODEL NO.	DESCRIPTION	SHIP WGT
SCH1-5	1-1/2" Hook (4 Pack)	1 lb
SCH1	1/2" Hook (4 Pack)	1 lb

OSHPD
Certification



WR-SFP
Single Foot Plate

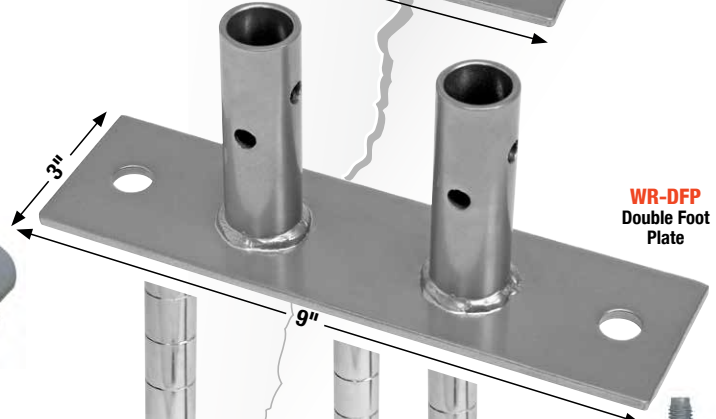

WR-DFP
Double Foot Plate



FP
Post Foot Plate
Triangular plate allows additional surface to disperse weight.
Finish: Chrome



FG
Non-Marring Floor Glides
Affixes to bottom of bolt. Serves as protection to prevent marring of floors.
Sold as a pack of 4 pieces.



WR-SP
Shelf Collar Plug
Sold as a pack of 4 pieces.
Finish: Chrome



WR-WMB, WR-WMBP
Post Wall Mount Bracket
Mounts post to wall securely.
2" clearance required.
Finish: Chrome and Green Epoxy



WR-SS
Split Sleeve
Sold as a pack of 4 pairs.
(Enough for one shelf)



WR-PMGP
Post Mount Grid Bracket
Sold as a pack of 4 pieces.

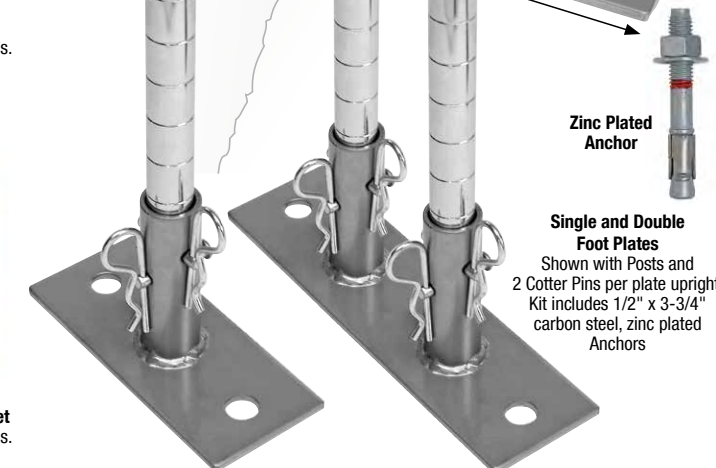

Zinc Plated Anchor

Single and Double Foot Plates
Shown with Posts and 2 Cotter Pins per plate upright.
Kit includes 1/2" x 3-3/4" carbon steel, zinc plated Anchors



**ADD YOUR CASTER KIT
TO YOUR UNIT FOR
MOBILITY**

**Up to 800-3,200 lb.
MOBILE LOAD CAPACITY**

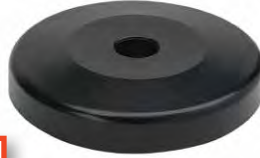

Donut Bumper

Non-marking, 3" diameter plastic bumper used to protect walls and help cushion impact.

MODEL NO.	DESCRIPTION	SHIP WGT
DB	One 3" Diameter Donut Bumper	1 lb

Casters

MODEL NO.	DESCRIPTION	LOAD CAPACITY PER CASTER	SHIP WGT
Stem Casters			
WR-00H	Four Swivel 5" x 1-1/4" Thermoplastic Resin Casters, 2 with brake	300 lbs	10 lbs
WR-00H-HD	Four Swivel 5-1/2" x 1-1/4" Heavy-Duty Polyurethane Casters, 2 with brake	600 lbs	12 lbs
WR-00HS	Four Swivel 5" x 1-1/4" Thermoplastic Resin Stainless Steel Casters with Zerk Grease Fittings, 2 with brake	300 lbs	12 lbs
WR-00CO	Four Swivel ESD/Conductive 5" x 1-1/4" Casters, 2 with brake	300 lbs	12 lbs
WR-SB2R2*	Two Swivel 5" x 1-1/4" Thermoplastic Resin Caster with brake, 2 Rigid	300 lbs	12 lbs
WR-3	Four Swivel 3" Polyurethane Casters, all with brake	200 lbs	8 lbs
WR-RG*	One Rigid 5" x 1-1/4" Thermoplastic Resin Caster	300 lbs	3 lbs
WR-PS	One Swivel 8" x 2-1/2" Pneumatic Caster	325 lbs	4 lbs
PSC-5S	5"x1-1/4" Polymer Swivel Casters, 2 with brake	200 lbs	9 lbs
Plate Casters			
PT-PS	One Swivel 5" x 1-1/4" Thermoplastic Resin Caster	300 lbs	3 lbs
PT-PR	One Rigid 5" x 1-1/4" Thermoplastic Resin Caster	300 lbs	3 lbs
PT-PSB	One Swivel 5" x 1-1/4" Thermoplastic Resin Caster with brake	300 lbs	3 lbs
PT-PS-S	One Swivel 5" x 1-1/4" Polyurethane Stainless Steel Caster with Zerk Grease Fittings	300 lbs	3 lbs
PT-PR-S	One Rigid 5" x 1-1/4" Polyurethane Stainless Steel Caster with Zerk Grease Fittings	300 lbs	3 lbs
PT-PSB-S	One Swivel 5" x 1-1/4" Polyurethane Stainless Steel Caster with brake with Zerk Grease Fittings	300 lbs	3 lbs
PT-PS6	One Swivel 6" x 2" Polyurethane Caster	800 lbs	5 lbs
PT-PR6	One Rigid 6" x 2" Polyurethane Caster	800 lbs	5 lbs
PT-PSB6	One Swivel 6" x 2" Polyurethane Caster with brake	800 lbs	5 lbs
PT-NS	One Swivel 8" x 2-1/2" Pneumatic Caster	325 lbs	4 lbs
PT-NR	One Rigid 8" x 2-1/2" Pneumatic Caster	325 lbs	4 lbs

*Requires Tie Bars for rigid alignment (See pg. 31)



WR-00H
Thermoplastic Resin Stem Casters
Shown with and without brake
Sold as a set of 4 casters, 2 with brake



WR-00H-HD
Heavy-Duty Polyurethane Stem Casters
Shown with and without brake
Sold as a set of 4 casters, 2 with brake



WR-00CO
Conductive Stem Casters
Shown with and without brake
Sold as a set of 4 casters, 2 with brake



WR-00HS
Stainless Steel Stem Casters
Shown with and without brake
Sold as a set of 4 casters, 2 with brake



PSC-5S
Polymer Stem Casters
Shown with and without brake
Sold as a set of 4 casters, 2 with brake



PT-PR
Rigid Thermoplastic Resin Plate Casters



PT-PS
Thermoplastic Resin Plate Casters
Shown with and without brake



WR-RG
Rigid Thermoplastic Resin Stem Casters
Requires Tie Bar
(See chart pg. 31)



WR-3
3" Polyurethane Stem Casters
Sold as a set of 4 casters, all with brake



PT-PR6
Rigid Polyurethane Plate Casters



PT-PS6
Polyurethane Plate Casters
Shown with and without brake



PT-PSB6



WR-PS
Pneumatic Stem Casters



PT-NR
Rigid Pneumatic Plate Casters



PT-NS
Pneumatic Plate Casters



UB10
Utility Basket

An additional storage or display area outside the perimeter of the shelf. Measures 18-7/8"W x 11-1/4"D x 7-5/8"H. Up to 25 lb. load capacity.
Finish: Chrome

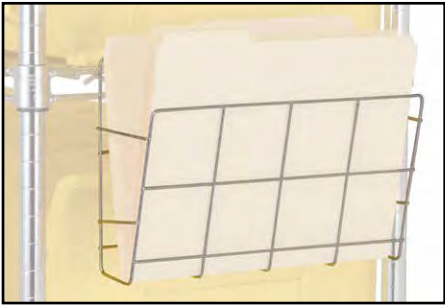

DH8
Document Holder

Provides an effective way to secure documents or folders. Measures 12-3/8"W x 2"D x 8-5/8"H. Up to 25 lb. load capacity.
Finish: Chrome

Shelf Inlay Mats

An economical solution to convert a wire shelf to a solid surface preventing items from falling through. White shelf inlay mat is easily removable for cleaning. Manufactured of polyethylene, .5 mm thickness.

MODEL NO.	DESCRIPTION	SHIP WGT
1836SM	One 18" x 36" Inlay Mat	1 lb
1848SM	One 18" x 48" Inlay Mat	2 lbs
1860SM	One 18" x 60" Inlay Mat	2 lbs
1872SM	One 18" x 72" Inlay Mat	2 lbs
2436SM	One 24" x 36" Inlay Mat	2 lbs
2448SM	One 24" x 48" Inlay Mat	2 lbs
2460SM	One 24" x 60" Inlay Mat	2 lbs
2472SM	One 24" x 72" Inlay Mat	3 lbs

CUSTOM SIZES AVAILABLE
call for details



EASY TO CLEAN
CREATES SPILL-SAFE SURFACE

Wire Shelf Covers



- Crystal clear and very sturdy
- Works with all brands of wire shelving
- Converts wire shelf to a solid shelf
- Solves any concern with burrs or rough edges or tearing on the wire
- Provides a spill-safe surface so that no liquid will fall through the wire
- Wire label holders can still be placed on the wire shelf and the cover's edge will fit over the front of the label holder
- Withstands temperatures from -20°F up to 170°F

MODEL NO.	DESCRIPTION	SHIP WGT
1836COV	One 18" x 36" Shelf Cover	2 lbs
1848COV	One 18" x 48" Shelf Cover	2 lbs
1860COV	One 18" x 60" Shelf Cover	2 lbs
1872COV	One 18" x 72" Shelf Cover	2 lbs
2436COV	One 24" x 36" Shelf Cover	2 lbs
2448COV	One 24" x 48" Shelf Cover	2 lbs
2460COV	One 24" x 60" Shelf Cover	2 lbs
2472COV	One 24" x 72" Shelf Cover	2 lbs



Polymer Shelf Label Holder



MODEL NO.	DESCRIPTION	SHIP WGT
Clear Label Holders		
ULH3C	3" Clear Label Holder	1 lb
ULH33C	33" Clear Label Holder Fits 36" Shelf	1 lb
ULH45C	45" Clear Label Holder Fits 48" Shelf	1 lb
ULH57C	57" Clear Label Holder Fits 60" Shelf	1 lb
ULH69C	69" Clear Label Holder Fits 72" Shelf	1 lb



Label Holders can also be used on Wire Shelves

Post Label Holders

New post label holders come in two sizes and allow for easy identification of aisles/rows as well as of wire cart contents. Attach to standard 1" diameter posts. Each package includes 12 clear holders and corresponding printer friendly sheet labels.

MODEL NO.	DIMENSIONS W" x L"	PKG QTY	SHIP WGT
PLH1X6C	1" x 6"	12 pcs	1 lb
PLH2X4C	2" x 4"	12 pcs	1 lb



EASY IDENTIFICATION OF AISLES/ROWS CONTENTS



Hanging Label Tags

7 COLORS AVAILABLE

New design Hanging Label tab has flat surface on one side to allow for self-adhesive label. Opposite side has a slot for label to be inserted and easily removed or changed as needed. Paper labels are not included. Label tags work with all wire shelves, mesh bins, hanging, stacking and post baskets. Available in 7 colors. Package of 25.

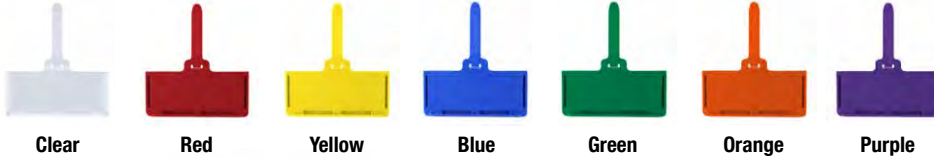

PS-LH3

Hanging Label Tag

Fits 1-3/8" x 3" Adhesive Label or Slide in Label

LHA3C



Shelf Label Holders

Are an excellent method for identifying product. Holders affix directly to snake frame front on any size shelf. (Label inserts sold separately)

EASILY IDENTIFY PRODUCT ON ANY SIZE SHELF



LH3C and LH3B Front Shelf View



LHA3C 3 Different Angles

MODEL NO.	DESCRIPTION	SHIP WGT
LH3B	3" Gray Label Holder	1 lb
LH3C	3" Clear Label Holder	1 lb
LH6C	6" Clear Label Holder	1 lb
LH12C	12" Clear Label Holder	1 lb
LH24C	24" Clear Label Holder	1 lb
Full Length Label Holders		
LH33C	33" Clear Label Holder Fits 36" Shelf	1 lb
LH39C	39" Clear Label Holder Fits 42" Shelf	1 lb
LH45C	45" Clear Label Holder Fits 48" Shelf	1 lb
LH51C	51" Clear Label Holder Fits 54" Shelf	2 lbs
LH57C	57" Clear Label Holder Fits 60" Shelf	2 lbs
LH69C	69" Clear Label Holder Fits 72" Shelf	2 lbs
Angled Label Holders - 30°, 60° and 90°		
LHA3C	3" Angled Clear Label Holder	1 lb
LHA5C	5" Angled Clear Label Holder	1 lb
LHA24C	24" Angled Clear Label Holder	1 lb

ANGLED LABEL HOLDER ADVANTAGE

**ANGLED LABEL HOLDERS
ALLOW YOU TO POSITION AND
PIVOT ANGLE TO BEST
SUIT YOUR NEEDS**

Laser and Inkjet Label Inserts

Laser and inkjet compatible inserts come in 8-1/2" x 11" perforated sheets. Available in 3" and 6" lengths. Multiple inserts can be used on longer label holders. Package of 48 labels.

MODEL NO.	DESCRIPTION	SHIP WGT
Laser and Inkjet Label Inserts - 48 Labels		
LHI-3	1-1/4" x 3" Inserts (3 Sheets)	1 lb
LHI-6	1-1/4" x 6" Inserts (6 Sheets)	1 lb



Inserts slide into label holders easily

NEED A LARGER SURFACE AREA FOR IDENTIFICATION?

New generation extended clear label holder clips onto the front snake frame of any wire shelf and offers a 3"H x 5"W label slot with paper insert. Labels can be changed or easily relocated. Laser and inkjet compatible inserts come in 8-1/2" x 11" perforated sheets. Package of 12.



LHE3X5C



Clear Label Holder

Stacking & Post Basket Clear Label Holders

A super easy method for identifying product. Affixes directly to the front on any stacking and post basket. Available in six lengths. (Label inserts sold separately)

MODEL NO.	DESCRIPTION	SHIP WGT
Clear Label Holders		
BLH3C	3" Clear Label Holder	1 lb
BLH14C	14" Clear Label Holder Fits 18" Wide Basket	1 lb
BLH20C	20" Clear Label Holder Fits 24" Wide Basket	1 lb
BLH32C	32" Clear Label Holder Fits 36" Wide Basket	1 lb
BLH44C	44" Clear Label Holder Fits 48" Wide Basket	1 lb
BLH56C	56" Clear Label Holder Fits 60" Wide Basket	1 lb

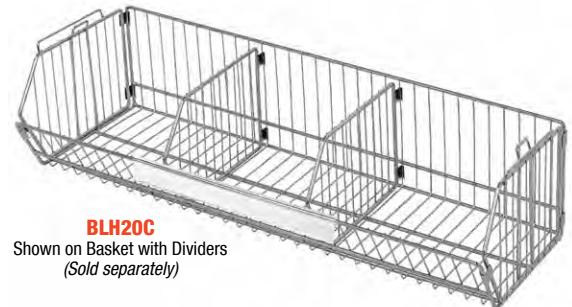

BLH20C

Shown on Basket with Dividers
(Sold separately)

Hanging Basket Clear Label Holders

A super easy method for identifying product. Affixes directly to the front on any hanging basket. Available in four lengths. (Label inserts sold separately)

MODEL NO.	DESCRIPTION	SHIP WGT
Clear Label Holders		
HBL3C	3" Clear Label Holder	1 lb
HBL165C	16-1/2" Clear Label Holder Fits 18" Wide Basket	1 lb
HBL345C	34-1/2" Clear Label Holder Fits 36" Wide Basket	1 lb
HBL465C	46-1/2" Clear Label Holder Fits 48" Wide Basket	1 lb

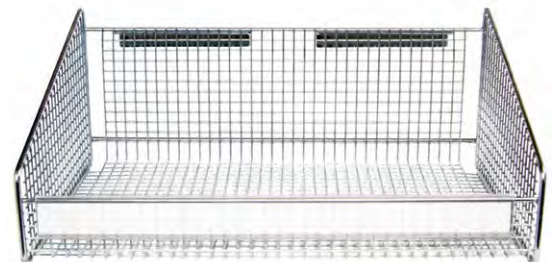

HBL165C

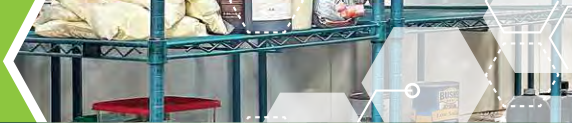

SOLID SHELVING

The solid steel design of these shelves is ideal for storage of small parts that might normally fall through wire shelves. Dual layer construction with double hemmed perimeter and marine edge ensures maximum strength while retaining spillage and excellent corrosion resistance.

All welded solid shelves are constructed of 18 gauge galvanized steel or 304 stainless steel.

By using various accessories, hundreds of shelving configurations become possible.



18 GAUGE
GALVANIZED



304
STAINLESS STEEL



Galvanized - is known as a hot-dipping process in which the steel is dipped in molten zinc. This extra layer adds corrosion resistance to the finalized product. Recommended to be used in any application in a dry storage environment. 1-year limited warranty.



Stainless Steel - 304 Stainless with an electro-polish finish represents the highest industry standard in the prevention of corrosion. This finish is highly effective for corrosive, high humidity or clean room environments. Lifetime warranty for 304 stainless steel electro-polish finish.

UNITS CAN BE LOADED/UNLOADED EASILY FROM ALL SIDES.



Solid Shelves



- Designed for storage of small parts that might normally fall through wire shelves
- Dual layer construction with double hemmed perimeter with marine edge ensures maximum strength while retaining spillage and excellent corrosion resistance

DIMENSIONS W" x L"	SHIP WGT	GALVANIZED STEEL	STAINLESS STEEL
		MODEL NO.	MODEL NO.
14" Deep - Solid Shelves			
14" x 30"	13 lbs	-	1430SS
14" x 36"	14 lbs	1436SG	1436SS
14" x 42"	15 lbs	1442SG	1442SS
14" x 48"	17 lbs	1448SG	1448SS
14" x 54"	20 lbs	1454SG	1454SS
14" x 60"	22 lbs	1460SG	1460SS
14" x 72"	26 lbs	1472SG	1472SS
18" Deep - Solid Shelves			
18" x 24"	11 lbs	1824SG	1824SS
18" x 30"	14 lbs	1830SG	1830SS
18" x 36"	16 lbs	1836SG	1836SS
18" x 42"	18 lbs	1842SG	1842SS
18" x 48"	20 lbs	1848SG	1848SS
18" x 54"	22 lbs	1854SG	1854SS
18" x 60"	24 lbs	1860SG	1860SS
18" x 72"	27 lbs	1872SG	1872SS
21" Deep - Solid Shelves			
21" x 24"	13 lbs	2124SG	2124SS
21" x 30"	15 lbs	2130SG	2130SS
21" x 36"	18 lbs	2136SG	2136SS
21" x 42"	21 lbs	2142SG	2142SS
21" x 48"	23 lbs	2148SG	2148SS
21" x 54"	25 lbs	2154SG	2154SS
21" x 60"	28 lbs	2160SG	2160SS
21" x 72"	30 lbs	2172SG	2172SS
24" Deep - Solid Shelves			
24" x 24"	15 lbs	2424SG	2424SS
24" x 30"	17 lbs	2430SG	2430SS
24" x 36"	19 lbs	2436SG	2436SS
24" x 42"	22 lbs	2442SG	2442SS
24" x 48"	24 lbs	2448SG	2448SS
24" x 54"	26 lbs	2454SG	2454SS
24" x 60"	31 lbs	2460SG	2460SS
24" x 72"	34 lbs	2472SG	2472SS



1836SG

18 GAUGE
GALVANIZED



1836SS

304
STAINLESS STEEL



Up to 400-600 lb.
LOAD CAPACITY PER SHELF

**EASY IDENTIFICATION OF
AISLES/ROWS CONTENTS**

Posts



All posts are fabricated from 16 gauge carbon steel with location grooves on one inch increments and ease for shelf installation. Numbers are printed between grooves for quick assembly. Posts are double grooved in consistent intervals for quick identification. Leveling legs are enclosed with all posts. Leveling legs cannot be used in conjunction with stem casters. Custom post heights are available, call for additional information.

DESCRIPTION	SHIP WGT	CHROME	STAINLESS STEEL
		MODEL NO.	MODEL NO.
6"H Post	1 lb	P6C	P6S
14"H Post	1 lb	P14C	P14S
34"H Post	2 lbs	P34C	P34S
36"H Post	2 lbs	P36C	-
39"H Post	2 lbs	P39C	-
42"H Post	2 lbs	-	P42S
54"H Post	3 lbs	P54C	P54S
63"H Post	4 lbs	P63C*	P63S
74"H Post	4 lbs	P74C*	P74S
86"H Post	5 lbs	P86C*	P86S
96"H Post	6 lbs	P96C	P96S

*For easy installation, 63", 74" and 86" posts are available with pre-inserted leveler and bolt by adding an X to the Model No. **P74CX**

W-PC
Replacement Post Cap
Additional pieces available
(Sold as 4-pack)

W-PC-STUD
Threaded Stud Connector can be utilized to connect two posts enabling any post height to be achieved. Must be used with **WR-WMB** to secure to wall

LASER PRINTED NUMBERS
For quick shelf positioning

W-PLI
Post Insert
Additional pieces available
(Sold as 4-pack)

W-PLB
Post Leveler adjusts up or down allowing height flexibility
(Sold as 4-pack)



PLH1X6C
Post Label
1" x 6"



PLH2X4C
Post Label
2" x 4"

Post Label Holders

New post label holders come in two sizes and allow for easy identification of aisles/rows as well as of wire cart contents. Attach to standard 1" diameter posts. Each package includes 12 clear holders and corresponding printer friendly sheet labels.

MODEL NO.	DIMENSIONS W" x L"	PKG QTY	SHIP WGT
PLH1X6C	1" x 6"	12 pcs	1 lb
PLH2X4C	2" x 4"	12 pcs	1 lb



STORAGE SOLID SHELVING - GALVANIZED STEEL UNITS

4 Shelf Starter Kits

Solid flat shelves allows for storage from small to large items, and the marine edge perimeter prevents spillage. The double hemmed 18 gauge galvanized steel provides the solid shelf excellent strength characteristics. All solid shelf units consist of 4 shelves and 4 posts. Mobilize starter kit shelving unit using optional mobile kit WR-00H, see **pg. 33**. **Finish:** Galvanized Steel



MOBILIZE YOUR SHELVING

DB - Donut Bumper
Non-marking donut bumper used to protect walls and help cushion impact.

WR-00H (Mobile Kit)*
Set of four swivel thermoplastic resin 5" x 1-1/4" casters, two with brakes. Can be used with all units shown. Up to 1,200 lb. load capacity. *Mobile kits recommended only for shelves 18" and deeper.



QSMC Shelf Clamp
Shelf Clamp eliminates 2 posts per shelving section. Two QSMC clamps are required per shelf. **Finish:** Aluminum (Sold individually)

4 SHELF STARTER KIT

4 Shelf Add-On Kits

Additional Add-On kits allow you to expand your Starter kit by sharing a set of posts. Configuration options include side to side, back to back and right angles (L-Shape). Add-on units consist of 4 shelves, 2 posts and 8 shelf clamps. Additional shelves and posts may be purchased separately, see chart on **pg. 37**. Units with Add-On kit cannot be made mobile. **Finish:** Galvanized Steel

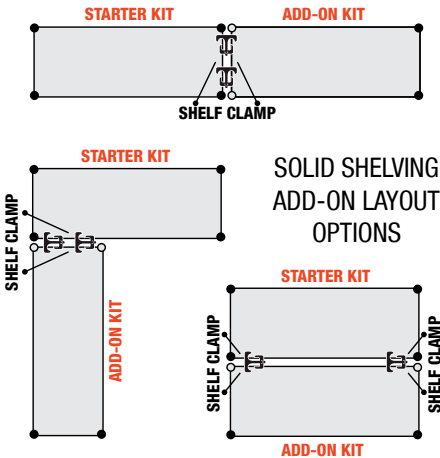

54" H - GALVANIZED SOLID SHELVING 4 SHELVES					63" H - GALVANIZED SOLID SHELVING 4 SHELVES				
STARTER KIT			ADD-ON KIT		STARTER KIT			ADD-ON KIT	
SHELF W" x L"	MODEL NO.	SHIP WGT	MODEL NO.	SHIP WGT	MODEL NO.	SHIP WGT	MODEL NO.	SHIP WGT	
14" x 36"	WR54-1436SG	68 lbs	AD54-1436SG	65 lbs	WR63-1436SG	72 lbs	AD63-1436SG	67 lbs	
14" x 42"	WR54-1442SG	72 lbs	AD54-1442SG	69 lbs	WR63-1442SG	76 lbs	AD63-1442SG	71 lbs	
14" x 48"	WR54-1448SG	80 lbs	AD54-1448SG	77 lbs	WR63-1448SG	84 lbs	AD63-1448SG	79 lbs	
14" x 54"	WR54-1454SG	92 lbs	AD54-1454SG	89 lbs	WR63-1454SG	96 lbs	AD63-1454SG	91 lbs	
14" x 60"	WR54-1460SG	100 lbs	AD54-1460SG	97 lbs	WR63-1460SG	104 lbs	AD63-1460SG	99 lbs	
14" x 72"	WR54-1472SG	116 lbs	AD54-1472SG	113 lbs	WR63-1472SG	120 lbs	AD63-1472SG	115 lbs	
18" x 24"	WR54-1824SG	56 lbs	AD54-1824SG	53 lbs	WR63-1824SG	60 lbs	AD63-1824SG	55 lbs	
18" x 30"	WR54-1830SG	68 lbs	AD54-1830SG	65 lbs	WR63-1830SG	72 lbs	AD63-1830SG	67 lbs	
18" x 36"	WR54-1836SG	76 lbs	AD54-1836SG	73 lbs	WR63-1836SG	80 lbs	AD63-1836SG	75 lbs	
18" x 42"	WR54-1842SG	84 lbs	AD54-1842SG	81 lbs	WR63-1842SG	88 lbs	AD63-1842SG	83 lbs	
18" x 48"	WR54-1848SG	92 lbs	AD54-1848SG	89 lbs	WR63-1848SG	96 lbs	AD63-1848SG	91 lbs	
18" x 54"	WR54-1854SG	100 lbs	AD54-1854SG	97 lbs	WR63-1854SG	104 lbs	AD63-1854SG	99 lbs	
18" x 60"	WR54-1860SG	108 lbs	AD54-1860SG	105 lbs	WR63-1860SG	112 lbs	AD63-1860SG	107 lbs	
18" x 72"	WR54-1872SG	120 lbs	AD54-1872SG	117 lbs	WR63-1872SG	124 lbs	AD63-1872SG	119 lbs	
21" x 24"	WR54-2124SG	64 lbs	AD54-2124SG	61 lbs	WR63-2124SG	68 lbs	AD63-2124SG	63 lbs	
21" x 30"	WR54-2130SG	72 lbs	AD54-2130SG	69 lbs	WR63-2130SG	76 lbs	AD63-2130SG	71 lbs	
21" x 36"	WR54-2136SG	84 lbs	AD54-2136SG	81 lbs	WR63-2136SG	88 lbs	AD63-2136SG	83 lbs	
21" x 42"	WR54-2142SG	96 lbs	AD54-2142SG	93 lbs	WR63-2142SG	100 lbs	AD63-2142SG	95 lbs	
21" x 48"	WR54-2148SG	104 lbs	AD54-2148SG	101 lbs	WR63-2148SG	108 lbs	AD63-2148SG	103 lbs	
21" x 54"	WR54-2154SG	112 lbs	AD54-2154SG	109 lbs	WR63-2154SG	116 lbs	AD63-2154SG	111 lbs	
21" x 60"	WR54-2160SG	124 lbs	AD54-2160SG	121 lbs	WR63-2160SG	128 lbs	AD63-2160SG	123 lbs	
21" x 72"	WR54-2172SG	132 lbs	AD54-2172SG	129 lbs	WR63-2172SG	136 lbs	AD63-2172SG	131 lbs	
24" x 24"	WR54-2424SG	72 lbs	AD54-2424SG	69 lbs	WR63-2424SG	76 lbs	AD63-2424SG	71 lbs	
24" x 30"	WR54-2430SG	80 lbs	AD54-2430SG	77 lbs	WR63-2430SG	84 lbs	AD63-2430SG	79 lbs	
24" x 36"	WR54-2436SG	88 lbs	AD54-2436SG	85 lbs	WR63-2436SG	92 lbs	AD63-2436SG	87 lbs	
24" x 42"	WR54-2442SG	100 lbs	AD54-2442SG	97 lbs	WR63-2442SG	104 lbs	AD63-2442SG	99 lbs	
24" x 48"	WR54-2448SG	108 lbs	AD54-2448SG	105 lbs	WR63-2448SG	112 lbs	AD63-2448SG	107 lbs	
24" x 54"	WR54-2454SG	124 lbs	AD54-2454SG	121 lbs	WR63-2454SG	128 lbs	AD63-2454SG	123 lbs	
24" x 60"	WR54-2460SG	136 lbs	AD54-2460SG	133 lbs	WR63-2460SG	140 lbs	AD63-2460SG	135 lbs	
24" x 72"	WR54-2472SG	148 lbs	AD54-2472SG	145 lbs	WR63-2472SG	152 lbs	AD63-2472SG	147 lbs	

Shelving units include 4 posts and 4 shelves. Add-On units include 2 posts, 4 shelves and 8 shelf clamps.

18 GAUGE GALVANIZED STEEL

Up to **400-600 lb.**
LOAD CAPACITY PER SHELF
EVENLY DISTRIBUTED

74" H - GALVANIZED SOLID SHELVING 4 SHELVES					86" H - GALVANIZED SOLID SHELVING 4 SHELVES				
STARTER KIT			ADD-ON KIT		STARTER KIT			ADD-ON KIT	
SHELF W" x L"	MODEL NO.	SHIP WGT	MODEL NO.	SHIP WGT	MODEL NO.	SHIP WGT	MODEL NO.	SHIP WGT	
14" x 36"	WR74-1436SG	72 lbs	AD74-1436SG	67 lbs	WR86-1436SG	76 lbs	AD86-1436SG	69 lbs	
14" x 42"	WR74-1442SG	76 lbs	AD74-1442SG	71 lbs	WR86-1442SG	80 lbs	AD86-1442SG	73 lbs	
14" x 48"	WR74-1448SG	84 lbs	AD74-1448SG	79 lbs	WR86-1448SG	88 lbs	AD86-1448SG	81 lbs	
14" x 54"	WR74-1454SG	96 lbs	AD74-1454SG	91 lbs	WR86-1454SG	100 lbs	AD86-1454SG	93 lbs	
14" x 60"	WR74-1460SG	104 lbs	AD74-1460SG	99 lbs	WR86-1460SG	108 lbs	AD86-1460SG	101 lbs	
14" x 72"	WR74-1472SG	120 lbs	AD74-1472SG	115 lbs	WR86-1472SG	124 lbs	AD86-1472SG	117 lbs	
18" x 24"	WR74-1824SG	60 lbs	AD74-1824SG	55 lbs	WR86-1824SG	64 lbs	AD86-1824SG	57 lbs	
18" x 30"	WR74-1830SG	72 lbs	AD74-1830SG	67 lbs	WR86-1830SG	76 lbs	AD86-1830SG	69 lbs	
18" x 36"	WR74-1836SG	80 lbs	AD74-1836SG	75 lbs	WR86-1836SG	84 lbs	AD86-1836SG	77 lbs	
18" x 42"	WR74-1842SG	88 lbs	AD74-1842SG	83 lbs	WR86-1842SG	92 lbs	AD86-1842SG	85 lbs	
18" x 48"	WR74-1848SG	96 lbs	AD74-1848SG	91 lbs	WR86-1848SG	100 lbs	AD86-1848SG	93 lbs	
18" x 54"	WR74-1854SG	104 lbs	AD74-1854SG	99 lbs	WR86-1854SG	108 lbs	AD86-1854SG	101 lbs	
18" x 60"	WR74-1860SG	112 lbs	AD74-1860SG	107 lbs	WR86-1860SG	116 lbs	AD86-1860SG	109 lbs	
18" x 72"	WR74-1872SG	124 lbs	AD74-1872SG	119 lbs	WR86-1872SG	128 lbs	AD86-1872SG	121 lbs	
21" x 24"	WR74-2124SG	68 lbs	AD74-2124SG	63 lbs	WR86-2124SG	72 lbs	AD86-2124SG	65 lbs	
21" x 30"	WR74-2130SG	76 lbs	AD74-2130SG	71 lbs	WR86-2130SG	80 lbs	AD86-2130SG	73 lbs	
21" x 36"	WR74-2136SG	88 lbs	AD74-2136SG	83 lbs	WR86-2136SG	92 lbs	AD86-2136SG	85 lbs	
21" x 42"	WR74-2142SG	100 lbs	AD74-2142SG	95 lbs	WR86-2142SG	104 lbs	AD86-2142SG	97 lbs	
21" x 48"	WR74-2148SG	108 lbs	AD74-2148SG	103 lbs	WR86-2148SG	112 lbs	AD86-2148SG	105 lbs	
21" x 54"	WR74-2154SG	116 lbs	AD74-2154SG	111 lbs	WR86-2154SG	120 lbs	AD86-2154SG	113 lbs	
21" x 60"	WR74-2160SG	128 lbs	AD74-2160SG	123 lbs	WR86-2160SG	132 lbs	AD86-2160SG	125 lbs	
21" x 72"	WR74-2172SG	136 lbs	AD74-2172SG	131 lbs	WR86-2172SG	140 lbs	AD86-2172SG	133 lbs	
24" x 24"	WR74-2424SG	76 lbs	AD74-2424SG	71 lbs	WR86-2424SG	80 lbs	AD86-2424SG	73 lbs	
24" x 30"	WR74-2430SG	84 lbs	AD74-2430SG	79 lbs	WR86-2430SG	88 lbs	AD86-2430SG	81 lbs	
24" x 36"	WR74-2436SG	92 lbs	AD74-2436SG	87 lbs	WR86-2436SG	96 lbs	AD86-2436SG	89 lbs	
24" x 42"	WR74-2442SG	104 lbs	AD74-2442SG	99 lbs	WR86-2442SG	108 lbs	AD86-2442SG	101 lbs	
24" x 48"	WR74-2448SG	112 lbs	AD74-2448SG	107 lbs	WR86-2448SG	116 lbs	AD86-2448SG	109 lbs	
24" x 54"	WR74-2454SG	128 lbs	AD74-2454SG	123 lbs	WR86-2454SG	132 lbs	AD86-2454SG	125 lbs	
24" x 60"	WR74-2460SG	140 lbs	AD74-2460SG	135 lbs	WR86-2460SG	144 lbs	AD86-2460SG	137 lbs	
24" x 72"	WR74-2472SG	152 lbs	AD74-2472SG	147 lbs	WR86-2472SG	156 lbs	AD86-2472SG	149 lbs	

Shelving units include 4 posts and 4 shelves. Add-On units include 2 posts, 4 shelves and 8 shelf clamps.



SHELF W" x L"	54"H - GALVANIZED SOLID SHELVING 5 SHELVES				63"H - GALVANIZED SOLID SHELVING 5 SHELVES			
	STARTER KIT		ADD-ON KIT		STARTER KIT		ADD-ON KIT	
	MODEL NO.	SHIP WGT	MODEL NO.	SHIP WGT	MODEL NO.	SHIP WGT	MODEL NO.	SHIP WGT
14" x 36"	WR54-1436SG-5	82 lbs	AD54-1436SG-5	79 lbs	WR63-1436SG-5	86 lbs	AD63-1436SG-5	81 lbs
14" x 42"	WR54-1442SG-5	87 lbs	AD54-1442SG-5	84 lbs	WR63-1442SG-5	91 lbs	AD63-1442SG-5	86 lbs
14" x 48"	WR54-1448SG-5	97 lbs	AD54-1448SG-5	94 lbs	WR63-1448SG-5	101 lbs	AD63-1448SG-5	96 lbs
14" x 54"	WR54-1454SG-5	112 lbs	AD54-1454SG-5	109 lbs	WR63-1454SG-5	116 lbs	AD63-1454SG-5	111 lbs
14" x 60"	WR54-1460SG-5	122 lbs	AD54-1460SG-5	119 lbs	WR63-1460SG-5	126 lbs	AD63-1460SG-5	121 lbs
14" x 72"	WR54-1472SG-5	142 lbs	AD54-1472SG-5	139 lbs	WR63-1472SG-5	146 lbs	AD63-1472SG-5	141 lbs
18" x 24"	WR54-1824SG-5	67 lbs	AD54-1824SG-5	64 lbs	WR63-1824SG-5	71 lbs	AD63-1824SG-5	66 lbs
18" x 30"	WR54-1830SG-5	82 lbs	AD54-1830SG-5	79 lbs	WR63-1830SG-5	86 lbs	AD63-1830SG-5	81 lbs
18" x 36"	WR54-1836SG-5	92 lbs	AD54-1836SG-5	89 lbs	WR63-1836SG-5	96 lbs	AD63-1836SG-5	91 lbs
18" x 42"	WR54-1842SG-5	102 lbs	AD54-1842SG-5	99 lbs	WR63-1842SG-5	106 lbs	AD63-1842SG-5	101 lbs
18" x 48"	WR54-1848SG-5	112 lbs	AD54-1848SG-5	109 lbs	WR63-1848SG-5	116 lbs	AD63-1848SG-5	111 lbs
18" x 54"	WR54-1854SG-5	122 lbs	AD54-1854SG-5	119 lbs	WR63-1854SG-5	126 lbs	AD63-1854SG-5	121 lbs
18" x 60"	WR54-1860SG-5	132 lbs	AD54-1860SG-5	129 lbs	WR63-1860SG-5	136 lbs	AD63-1860SG-5	131 lbs
18" x 72"	WR54-1872SG-5	147 lbs	AD54-1872SG-5	144 lbs	WR63-1872SG-5	151 lbs	AD63-1872SG-5	146 lbs
21" x 24"	WR54-2124SG-5	77 lbs	AD54-2124SG-5	74 lbs	WR63-2124SG-5	81 lbs	AD63-2124SG-5	76 lbs
21" x 30"	WR54-2130SG-5	87 lbs	AD54-2130SG-5	84 lbs	WR63-2130SG-5	91 lbs	AD63-2130SG-5	86 lbs
21" x 36"	WR54-2136SG-5	102 lbs	AD54-2136SG-5	99 lbs	WR63-2136SG-5	106 lbs	AD63-2136SG-5	101 lbs
21" x 42"	WR54-2142SG-5	112 lbs	AD54-2142SG-5	114 lbs	WR63-2142SG-5	121 lbs	AD63-2142SG-5	116 lbs
21" x 48"	WR54-2148SG-5	127 lbs	AD54-2148SG-5	124 lbs	WR63-2148SG-5	131 lbs	AD63-2148SG-5	126 lbs
21" x 54"	WR54-2154SG-5	137 lbs	AD54-2154SG-5	134 lbs	WR63-2154SG-5	141 lbs	AD63-2154SG-5	136 lbs
21" x 60"	WR54-2160SG-5	152 lbs	AD54-2160SG-5	149 lbs	WR63-2160SG-5	156 lbs	AD63-2160SG-5	151 lbs
21" x 72"	WR54-2172SG-5	162 lbs	AD54-2172SG-5	159 lbs	WR63-2172SG-5	166 lbs	AD63-2172SG-5	161 lbs
24" x 24"	WR54-2424SG-5	87 lbs	AD54-2424SG-5	84 lbs	WR63-2424SG-5	91 lbs	AD63-2424SG-5	86 lbs
24" x 30"	WR54-2430SG-5	97 lbs	AD54-2430SG-5	94 lbs	WR63-2430SG-5	101 lbs	AD63-2430SG-5	96 lbs
24" x 36"	WR54-2436SG-5	107 lbs	AD54-2436SG-5	104 lbs	WR63-2436SG-5	111 lbs	AD63-2436SG-5	106 lbs
24" x 42"	WR54-2442SG-5	122 lbs	AD54-2442SG-5	119 lbs	WR63-2442SG-5	126 lbs	AD63-2442SG-5	121 lbs
24" x 48"	WR54-2448SG-5	132 lbs	AD54-2448SG-5	129 lbs	WR63-2448SG-5	136 lbs	AD63-2448SG-5	131 lbs
24" x 54"	WR54-2454SG-5	152 lbs	AD54-2454SG-5	149 lbs	WR63-2454SG-5	156 lbs	AD63-2454SG-5	151 lbs
24" x 60"	WR54-2460SG-5	167 lbs	AD54-2460SG-5	164 lbs	WR63-2460SG-5	171 lbs	AD63-2460SG-5	166 lbs
24" x 72"	WR54-2472SG-5	182 lbs	AD54-2472SG-5	179 lbs	WR63-2472SG-5	186 lbs	AD63-2472SG-5	181 lbs

Shelving units include 4 posts and 5 shelves. Add-On units include 2 posts, 5 shelves and 10 shelf clamps.

18 GAUGE
GALVANIZED STEEL

Up to **400-600 lb.**
LOAD CAPACITY PER SHELF
EVENLY DISTRIBUTED

SHELF W" x L"	74"H - GALVANIZED SOLID SHELVING 5 SHELVES				86"H - GALVANIZED SOLID SHELVING 5 SHELVES			
	STARTER KIT		ADD-ON KIT		STARTER KIT		ADD-ON KIT	
	MODEL NO.	SHIP WGT	MODEL NO.	SHIP WGT	MODEL NO.	SHIP WGT	MODEL NO.	SHIP WGT
14" x 36"	WR74-1436SG-5	86 lbs	AD74-1436SG-5	81 lbs	WR86-1436SG-5	90 lbs	AD86-1436SG-5	83 lbs
14" x 42"	WR74-1442SG-5	91 lbs	AD74-1442SG-5	86 lbs	WR86-1442SG-5	95 lbs	AD86-1442SG-5	88 lbs
14" x 48"	WR74-1448SG-5	101 lbs	AD74-1448SG-5	91 lbs	WR86-1448SG-5	105 lbs	AD86-1448SG-5	98 lbs
14" x 54"	WR74-1454SG-5	116 lbs	AD74-1454SG-5	111 lbs	WR86-1454SG-5	120 lbs	AD86-1454SG-5	113 lbs
14" x 60"	WR74-1460SG-5	126 lbs	AD74-1460SG-5	121 lbs	WR86-1460SG-5	130 lbs	AD86-1460SG-5	123 lbs
14" x 72"	WR74-1472SG-5	146 lbs	AD74-1472SG-5	141 lbs	WR86-1472SG-5	150 lbs	AD86-1472SG-5	143 lbs
18" x 24"	WR74-1824SG-5	71 lbs	AD74-1824SG-5	66 lbs	WR86-1824SG-5	75 lbs	AD86-1824SG-5	68 lbs
18" x 30"	WR74-1830SG-5	86 lbs	AD74-1830SG-5	81 lbs	WR86-1830SG-5	90 lbs	AD86-1830SG-5	83 lbs
18" x 36"	WR74-1836SG-5	96 lbs	AD74-1836SG-5	91 lbs	WR86-1836SG-5	100 lbs	AD86-1836SG-5	93 lbs
18" x 42"	WR74-1842SG-5	106 lbs	AD74-1842SG-5	101 lbs	WR86-1842SG-5	110 lbs	AD86-1842SG-5	103 lbs
18" x 48"	WR74-1848SG-5	116 lbs	AD74-1848SG-5	111 lbs	WR86-1848SG-5	120 lbs	AD86-1848SG-5	113 lbs
18" x 54"	WR74-1854SG-5	126 lbs	AD74-1854SG-5	121 lbs	WR86-1854SG-5	130 lbs	AD86-1854SG-5	123 lbs
18" x 60"	WR74-1860SG-5	136 lbs	AD74-1860SG-5	131 lbs	WR86-1860SG-5	140 lbs	AD86-1860SG-5	133 lbs
18" x 72"	WR74-1872SG-5	151 lbs	AD74-1872SG-5	151 lbs	WR86-1872SG-5	155 lbs	AD86-1872SG-5	153 lbs
21" x 24"	WR74-2124SG-5	81 lbs	AD74-2124SG-5	76 lbs	WR86-2124SG-5	85 lbs	AD86-2124SG-5	78 lbs
21" x 30"	WR74-2130SG-5	91 lbs	AD74-2130SG-5	86 lbs	WR86-2130SG-5	95 lbs	AD86-2130SG-5	88 lbs
21" x 36"	WR74-2136SG-5	106 lbs	AD74-2136SG-5	101 lbs	WR86-2136SG-5	110 lbs	AD86-2136SG-5	103 lbs
21" x 42"	WR74-2142SG-5	121 lbs	AD74-2142SG-5	116 lbs	WR86-2142SG-5	125 lbs	AD86-2142SG-5	118 lbs
21" x 48"	WR74-2148SG-5	131 lbs	AD74-2148SG-5	121 lbs	WR86-2148SG-5	135 lbs	AD86-2148SG-5	123 lbs
21" x 54"	WR74-2154SG-5	141 lbs	AD74-2154SG-5	136 lbs	WR86-2154SG-5	145 lbs	AD86-2154SG-5	138 lbs
21" x 60"	WR74-2160SG-5	156 lbs	AD74-2160SG-5	151 lbs	WR86-2160SG-5	160 lbs	AD86-2160SG-5	153 lbs
21" x 72"	WR74-2172SG-5	166 lbs	AD74-2172SG-5	166 lbs	WR86-2172SG-5	170 lbs	AD86-2172SG-5	168 lbs
24" x 24"	WR74-2424SG-5	91 lbs	AD74-2424SG-5	86 lbs	WR86-2424SG-5	95 lbs	AD86-2424SG-5	88 lbs
24" x 30"	WR74-2430SG-5	101 lbs	AD74-2430SG-5	96 lbs	WR86-2430SG-5	105 lbs	AD86-2430SG-5	98 lbs
24" x 36"	WR74-2436SG-5	111 lbs	AD74-2436SG-5	106 lbs	WR86-2436SG-5	115 lbs	AD86-2436SG-5	108 lbs
24" x 42"	WR74-2442SG-5	126 lbs	AD74-2442SG-5	121 lbs	WR86-2442SG-5	130 lbs	AD86-2442SG-5	123 lbs
24" x 48"	WR74-2448SG-5	136 lbs	AD74-2448SG-5	131 lbs	WR86-2448SG-5	140 lbs	AD86-2448SG-5	133 lbs
24" x 54"	WR74-2454SG-5	156 lbs	AD74-2454SG-5	151 lbs	WR86-2454SG-5	160 lbs	AD86-2454SG-5	153 lbs
24" x 60"	WR74-2460SG-5	171 lbs	AD74-2460SG-5	166 lbs	WR86-2460SG-5	175 lbs	AD86-2460SG-5	168 lbs
24" x 72"	WR74-2472SG-5	186 lbs	AD74-2472SG-5	181 lbs	WR86-2472SG-5	205 lbs	AD86-2472SG-5	198 lbs

Shelving units include 4 posts and 5 shelves. Add-On units include 2 posts, 5 shelves and 10 shelf clamps.

5 Shelf Starter Kits

Solid flat shelves allows for storage from small to large items, and the marine edge perimeter prevents spillage. The double hemmed 18 gauge galvanized steel gives the solid shelf excellent strength characteristics. All solid shelf units consist of 5 shelves and 4 posts. Mobilize starter kit shelving unit using optional mobile kit WR-00H, see pg. 33. *Finish:* Galvanized Steel



MOBILIZE YOUR SHELVING

DB - Donut Bumper
Non-marking donut bumper used to protect walls and help cushion impact.

WR-00H (Mobile Kit)*
Set of four swivel thermoplastic resin 5" x 1-1/4" casters, two with brakes. Can be used with all units shown. Up to 1,200 lb. load capacity. *Mobile kits recommended only for shelves 18" and deeper.



QSMC Shelf Clamp
Shelf Clamp eliminates 2 posts per shelving section. Two QSMC clamps are required per shelf. *Finish:* Aluminum (Sold individually)



5 SHELF ADD-ON KIT

5 Shelf Add-On Kits

Additional Add-On kit allows you to expand your Starter kit by sharing a set of posts. Configuration options include side to side, back to back and right angles (L-Shape). Add-on units consist of 5 shelves, 2 posts and 10 shelf clamps. Additional shelves and posts may be purchased separately, see chart on pg. 37. Units with Add-On kit cannot be made mobile. *Finish:* Galvanized Steel

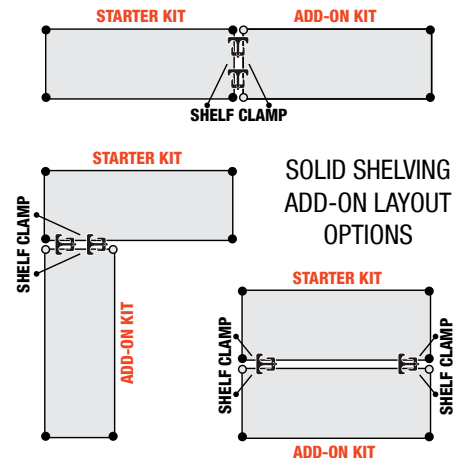



4 Shelf Starter Kits

Solid flat shelves allows for storage from small to large items, and the marine edge perimeter prevents spillage. The double hemmed 18 gauge 304 stainless steel gives the solid shelf excellent strength characteristics. All solid shelf units consist of 4 shelves and 4 posts. Mobilize starter kit shelving unit using optional mobile kit **WR-00HS**, see *pg. 33*. *Finish: Stainless Steel*



MOBILIZE YOUR SHELVING

DB - Donut Bumper

Non-marking donut bumper used to protect walls and help cushion impact.

WR-00HS (Mobile Kit)*

Set of four swivel 5" x 1-1/4" thermo-plastic resin stainless steel casters with zerk grease fittings, 2 with brake. Can be used with all units shown. 1,200 lb. load capacity. *Mobile kits recommended only for shelves 18" and deeper.



4 SHELF STARTER KIT



QSMC Shelf Clamp
Shelf Clamp eliminates 2 post per shelving section. Two QSMC clamps are required per shelf. *Finish: Aluminum (Sold individually)*

4 Shelf Add-On Kits

Additional Add-On kits allow you to expand your Starter kit by sharing a set of posts. Configuration options include side to side, back to back and right angles (*L-Shape*). Add-on units consist of 4 shelves, 2 posts and 8 shelf clamps. Additional shelves and posts may be purchased separately, see chart on *pg. 37*. Units with Add-On kit cannot be made mobile. *Finish: Stainless Steel*

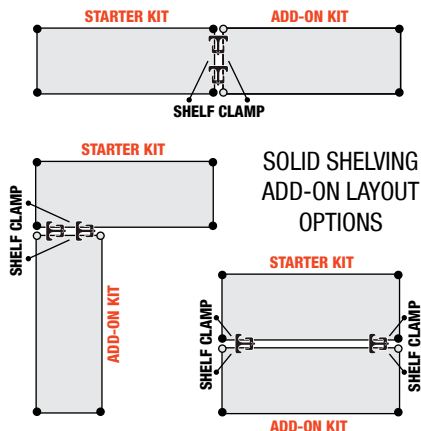

SHELF W" x L"	54"H - STAINLESS SOLID SHELVING 4 SHELVES				63"H - STAINLESS SOLID SHELVING 4 SHELVES			
	STARTER KIT		ADD-ON KIT		STARTER KIT		ADD-ON KIT	
	MODEL NO.	SHIP WGT	MODEL NO.	SHIP WGT	MODEL NO.	SHIP WGT	MODEL NO.	SHIP WGT
14" x 36"	WRS4-54-1436SS	68 lbs	WRSAD4-54-1436SS	65 lbs	WRS4-63-1436SS	72 lbs	WRSAD4-63-1436SS	67 lbs
14" x 42"	WRS4-54-1442SS	72 lbs	WRSAD4-54-1442SS	69 lbs	WRS4-63-1442SS	76 lbs	WRSAD4-63-1442SS	71 lbs
14" x 48"	WRS4-54-1448SS	80 lbs	WRSAD4-54-1448SS	77 lbs	WRS4-63-1448SS	84 lbs	WRSAD4-63-1448SS	79 lbs
14" x 54"	WRS4-54-1454SS	92 lbs	WRSAD4-54-1454SS	89 lbs	WRS4-63-1454SS	96 lbs	WRSAD4-63-1454SS	91 lbs
14" x 60"	WRS4-54-1460SS	100 lbs	WRSAD4-54-1460SS	97 lbs	WRS4-63-1460SS	104 lbs	WRSAD4-63-1460SS	99 lbs
14" x 72"	WRS4-54-1472SS	116 lbs	WRSAD4-54-1472SS	113 lbs	WRS4-63-1472SS	120 lbs	WRSAD4-63-1472SS	115 lbs
18" x 24"	WRS4-54-1824SS	56 lbs	WRSAD4-54-1824SS	53 lbs	WRS4-63-1824SS	60 lbs	WRSAD4-63-1824SS	55 lbs
18" x 30"	WRS4-54-1830SS	68 lbs	WRSAD4-54-1830SS	65 lbs	WRS4-63-1830SS	72 lbs	WRSAD4-63-1830SS	67 lbs
18" x 36"	WRS4-54-1836SS	76 lbs	WRSAD4-54-1836SS	73 lbs	WRS4-63-1836SS	80 lbs	WRSAD4-63-1836SS	75 lbs
18" x 42"	WRS4-54-1842SS	84 lbs	WRSAD4-54-1842SS	81 lbs	WRS4-63-1842SS	88 lbs	WRSAD4-63-1842SS	83 lbs
18" x 48"	WRS4-54-1848SS	92 lbs	WRSAD4-54-1848SS	89 lbs	WRS4-63-1848SS	96 lbs	WRSAD4-63-1848SS	91 lbs
18" x 54"	WRS4-54-1854SS	100 lbs	WRSAD4-54-1854SS	97 lbs	WRS4-63-1854SS	104 lbs	WRSAD4-63-1854SS	99 lbs
18" x 60"	WRS4-54-1860SS	108 lbs	WRSAD4-54-1860SS	105 lbs	WRS4-63-1860SS	112 lbs	WRSAD4-63-1860SS	107 lbs
18" x 72"	WRS4-54-1872SS	120 lbs	WRSAD4-54-1872SS	117 lbs	WRS4-63-1872SS	124 lbs	WRSAD4-63-1872SS	119 lbs
21" x 24"	WRS4-54-2124SS	64 lbs	WRSAD4-54-2124SS	61 lbs	WRS4-63-2124SS	68 lbs	WRSAD4-63-2124SS	63 lbs
21" x 30"	WRS4-54-2130SS	72 lbs	WRSAD4-54-2130SS	69 lbs	WRS4-63-2130SS	76 lbs	WRSAD4-63-2130SS	71 lbs
21" x 36"	WRS4-54-2136SS	84 lbs	WRSAD4-54-2136SS	81 lbs	WRS4-63-2136SS	88 lbs	WRSAD4-63-2136SS	83 lbs
21" x 42"	WRS4-54-2142SS	96 lbs	WRSAD4-54-2142SS	93 lbs	WRS4-63-2142SS	100 lbs	WRSAD4-63-2142SS	95 lbs
21" x 48"	WRS4-54-2148SS	104 lbs	WRSAD4-54-2148SS	101 lbs	WRS4-63-2148SS	108 lbs	WRSAD4-63-2148SS	103 lbs
21" x 54"	WRS4-54-2154SS	112 lbs	WRSAD4-54-2154SS	109 lbs	WRS4-63-2154SS	116 lbs	WRSAD4-63-2154SS	111 lbs
21" x 60"	WRS4-54-2160SS	124 lbs	WRSAD4-54-2160SS	121 lbs	WRS4-63-2160SS	128 lbs	WRSAD4-63-2160SS	123 lbs
21" x 72"	WRS4-54-2172SS	132 lbs	WRSAD4-54-2172SS	129 lbs	WRS4-63-2172SS	136 lbs	WRSAD4-63-2172SS	131 lbs
24" x 24"	WRS4-54-2424SS	72 lbs	WRSAD4-54-2424SS	69 lbs	WRS4-63-2424SS	76 lbs	WRSAD4-63-2424SS	71 lbs
24" x 30"	WRS4-54-2430SS	80 lbs	WRSAD4-54-2430SS	77 lbs	WRS4-63-2430SS	84 lbs	WRSAD4-63-2430SS	79 lbs
24" x 36"	WRS4-54-2436SS	88 lbs	WRSAD4-54-2436SS	85 lbs	WRS4-63-2436SS	92 lbs	WRSAD4-63-2436SS	87 lbs
24" x 42"	WRS4-54-2442SS	100 lbs	WRSAD4-54-2442SS	97 lbs	WRS4-63-2442SS	104 lbs	WRSAD4-63-2442SS	99 lbs
24" x 48"	WRS4-54-2448SS	108 lbs	WRSAD4-54-2448SS	105 lbs	WRS4-63-2448SS	112 lbs	WRSAD4-63-2448SS	107 lbs
24" x 54"	WRS4-54-2454SS	124 lbs	WRSAD4-54-2454SS	121 lbs	WRS4-63-2454SS	128 lbs	WRSAD4-63-2454SS	123 lbs
24" x 60"	WRS4-54-2460SS	136 lbs	WRSAD4-54-2460SS	133 lbs	WRS4-63-2460SS	140 lbs	WRSAD4-63-2460SS	135 lbs
24" x 72"	WRS4-54-2472SS	148 lbs	WRSAD4-54-2472SS	145 lbs	WRS4-63-2472SS	152 lbs	WRSAD4-63-2472SS	147 lbs

Shelving units include 4 posts and 4 shelves. Add-On units include 2 posts, 4 shelves and 8 shelf clamps.

304
STAINLESS STEEL

Up to 400-600 lb.
LOAD CAPACITY PER SHELF

SHELF W" x L"	74"H - STAINLESS SOLID SHELVING 4 SHELVES				86"H - STAINLESS SOLID SHELVING 4 SHELVES			
	STARTER KIT		ADD-ON KIT		STARTER KIT		ADD-ON KIT	
	MODEL NO.	SHIP WGT	MODEL NO.	SHIP WGT	MODEL NO.	SHIP WGT	MODEL NO.	SHIP WGT
14" x 36"	WRS4-74-1436SS	72 lbs	WRSAD4-74-1436SS	67 lbs	WRS4-86-1436SS	76 lbs	WRSAD4-86-1436SS	69 lbs
14" x 42"	WRS4-74-1442SS	76 lbs	WRSAD4-74-1442SS	71 lbs	WRS4-86-1442SS	80 lbs	WRSAD4-86-1442SS	73 lbs
14" x 48"	WRS4-74-1448SS	84 lbs	WRSAD4-74-1448SS	79 lbs	WRS4-86-1448SS	88 lbs	WRSAD4-86-1448SS	81 lbs
14" x 54"	WRS4-74-1454SS	96 lbs	WRSAD4-74-1454SS	91 lbs	WRS4-86-1454SS	100 lbs	WRSAD4-86-1454SS	93 lbs
14" x 60"	WRS4-74-1460SS	104 lbs	WRSAD4-74-1460SS	99 lbs	WRS4-86-1460SS	108 lbs	WRSAD4-86-1460SS	101 lbs
14" x 72"	WRS4-74-1472SS	120 lbs	WRSAD4-74-1472SS	115 lbs	WRS4-86-1472SS	124 lbs	WRSAD4-86-1472SS	117 lbs
18" x 24"	WRS4-74-1824SS	60 lbs	WRSAD4-74-1824SS	55 lbs	WRS4-86-1824SS	64 lbs	WRSAD4-86-1824SS	57 lbs
18" x 30"	WRS4-74-1830SS	72 lbs	WRSAD4-74-1830SS	67 lbs	WRS4-86-1830SS	76 lbs	WRSAD4-86-1830SS	69 lbs
18" x 36"	WRS4-74-1836SS	80 lbs	WRSAD4-74-1836SS	75 lbs	WRS4-86-1836SS	84 lbs	WRSAD4-86-1836SS	77 lbs
18" x 42"	WRS4-74-1842SS	88 lbs	WRSAD4-74-1842SS	83 lbs	WRS4-86-1842SS	92 lbs	WRSAD4-86-1842SS	85 lbs
18" x 48"	WRS4-74-1848SS	96 lbs	WRSAD4-74-1848SS	91 lbs	WRS4-86-1848SS	100 lbs	WRSAD4-86-1848SS	93 lbs
18" x 54"	WRS4-74-1854SS	104 lbs	WRSAD4-74-1854SS	99 lbs	WRS4-86-1854SS	108 lbs	WRSAD4-86-1854SS	101 lbs
18" x 60"	WRS4-74-1860SS	112 lbs	WRSAD4-74-1860SS	107 lbs	WRS4-86-1860SS	116 lbs	WRSAD4-86-1860SS	109 lbs
18" x 72"	WRS4-74-1872SS	124 lbs	WRSAD4-74-1872SS	119 lbs	WRS4-86-1872SS	128 lbs	WRSAD4-86-1872SS	121 lbs
21" x 24"	WRS4-74-2124SS	68 lbs	WRSAD4-74-2124SS	63 lbs	WRS4-86-2124SS	72 lbs	WRSAD4-86-2124SS	65 lbs
21" x 30"	WRS4-74-2130SS	76 lbs	WRSAD4-74-2130SS	71 lbs	WRS4-86-2130SS	80 lbs	WRSAD4-86-2130SS	73 lbs
21" x 36"	WRS4-74-2136SS	88 lbs	WRSAD4-74-2136SS	83 lbs	WRS4-86-2136SS	92 lbs	WRSAD4-86-2136SS	85 lbs
21" x 42"	WRS4-74-2142SS	100 lbs	WRSAD4-74-2142SS	95 lbs	WRS4-86-2142SS	104 lbs	WRSAD4-86-2142SS	97 lbs
21" x 48"	WRS4-74-2148SS	108 lbs	WRSAD4-74-2148SS	103 lbs	WRS4-86-2148SS	112 lbs	WRSAD4-86-2148SS	105 lbs
21" x 54"	WRS4-74-2154SS	116 lbs	WRSAD4-74-2154SS	111 lbs	WRS4-86-2154SS	120 lbs	WRSAD4-86-2154SS	113 lbs
21" x 60"	WRS4-74-2160SS	128 lbs	WRSAD4-74-2160SS	123 lbs	WRS4-86-2160SS	132 lbs	WRSAD4-86-2160SS	125 lbs
21" x 72"	WRS4-74-2172SS	136 lbs	WRSAD4-74-2172SS	131 lbs	WRS4-86-2172SS	140 lbs	WRSAD4-86-2172SS	133 lbs
24" x 24"	WRS4-74-2424SS	76 lbs	WRSAD4-74-2424SS	71 lbs	WRS4-86-2424SS	80 lbs	WRSAD4-86-2424SS	73 lbs
24" x 30"	WRS4-74-2430SS	84 lbs	WRSAD4-74-2430SS	79 lbs	WRS4-86-2430SS	88 lbs	WRSAD4-86-2430SS	81 lbs
24" x 36"	WRS4-74-2436SS	92 lbs	WRSAD4-74-2436SS	87 lbs	WRS4-86-2436SS	96 lbs	WRSAD4-86-2436SS	89 lbs
24" x 42"	WRS4-74-2442SS	104 lbs	WRSAD4-74-2442SS	99 lbs	WRS4-86-2442SS	108 lbs	WRSAD4-86-2442SS	101 lbs
24" x 48"	WRS4-74-2448SS	112 lbs	WRSAD4-74-2448SS	107 lbs	WRS4-86-2448SS	116 lbs	WRSAD4-86-2448SS	109 lbs
24" x 54"	WRS4-74-2454SS	128 lbs	WRSAD4-74-2454SS	123 lbs	WRS4-86-2454SS	132 lbs	WRSAD4-86-2454SS	125 lbs
24" x 60"	WRS4-74-2460SS	140 lbs	WRSAD4-74-2460SS	135 lbs	WRS4-86-2460SS	144 lbs	WRSAD4-86-2460SS	137 lbs
24" x 72"	WRS4-74-2472SS	152 lbs	WRSAD4-74-2472SS	147 lbs	WRS4-86-2472SS	156 lbs	WRSAD4-86-2472SS	149 lbs

Shelving units include 4 posts and 4 shelves. Add-On units include 2 posts, 4 shelves and 8 shelf clamps.



5 Shelf Starter Kits

Solid flat shelves allows for storage from small to large items, and the marine edge perimeter prevents spillage. The double hemmed 18 gauge 304 stainless steel gives the solid shelf excellent strength characteristics. All solid shelf units consist of 5 shelves and 4 posts. Mobilize starter kit shelving unit using optional mobile kit WR-00HS, see pg. 33. *Finish:* Stainless Steel

SHELF W" x L"	54"H - STAINLESS SOLID SHELVING 5 SHELVES				63"H - STAINLESS SOLID SHELVING 5 SHELVES			
	STARTER KIT		ADD-ON KIT		STARTER KIT		ADD-ON KIT	
MODEL NO.	SHIP WGT	MODEL NO.	SHIP WGT	MODEL NO.	SHIP WGT	MODEL NO.	SHIP WGT	
14" x 36"	WRS5-54-1436SS	82 lbs	WRSAD5-54-1436SS	79 lbs	WRS5-63-1436SS	86 lbs	WRSAD5-63-1436SS	81 lbs
14" x 42"	WRS5-54-1442SS	87 lbs	WRSAD5-54-1442SS	84 lbs	WRS5-63-1442SS	91 lbs	WRSAD5-63-1442SS	86 lbs
14" x 48"	WRS5-54-1448SS	97 lbs	WRSAD5-54-1448SS	94 lbs	WRS5-63-1448SS	101 lbs	WRSAD5-63-1448SS	96 lbs
14" x 54"	WRS5-54-1454SS	112 lbs	WRSAD5-54-1454SS	109 lbs	WRS5-63-1454SS	116 lbs	WRSAD5-63-1454SS	111 lbs
14" x 60"	WRS5-54-1460SS	122 lbs	WRSAD5-54-1460SS	119 lbs	WRS5-63-1460SS	126 lbs	WRSAD5-63-1460SS	121 lbs
14" x 72"	WRS5-54-1472SS	142 lbs	WRSAD5-54-1472SS	139 lbs	WRS5-63-1472SS	146 lbs	WRSAD5-63-1472SS	141 lbs
18" x 24"	WRS5-54-1824SS	67 lbs	WRSAD5-54-1824SS	64 lbs	WRS5-63-1824SS	71 lbs	WRSAD5-63-1824SS	66 lbs
18" x 30"	WRS5-54-1830SS	82 lbs	WRSAD5-54-1830SS	79 lbs	WRS5-63-1830SS	86 lbs	WRSAD5-63-1830SS	81 lbs
18" x 36"	WRS5-54-1836SS	92 lbs	WRSAD5-54-1836SS	89 lbs	WRS5-63-1836SS	96 lbs	WRSAD5-63-1836SS	91 lbs
18" x 42"	WRS5-54-1842SS	102 lbs	WRSAD5-54-1842SS	99 lbs	WRS5-63-1842SS	106 lbs	WRSAD5-63-1842SS	101 lbs
18" x 48"	WRS5-54-1848SS	112 lbs	WRSAD5-54-1848SS	109 lbs	WRS5-63-1848SS	116 lbs	WRSAD5-63-1848SS	111 lbs
18" x 54"	WRS5-54-1854SS	122 lbs	WRSAD5-54-1854SS	119 lbs	WRS5-63-1854SS	126 lbs	WRSAD5-63-1854SS	121 lbs
18" x 60"	WRS5-54-1860SS	132 lbs	WRSAD5-54-1860SS	129 lbs	WRS5-63-1860SS	136 lbs	WRSAD5-63-1860SS	131 lbs
18" x 72"	WRS5-54-1872SS	147 lbs	WRSAD5-54-1872SS	144 lbs	WRS5-63-1872SS	151 lbs	WRSAD5-63-1872SS	146 lbs
21" x 24"	WRS5-54-2124SS	77 lbs	WRSAD5-54-2124SS	74 lbs	WRS5-63-2124SS	81 lbs	WRSAD5-63-2124SS	76 lbs
21" x 30"	WRS5-54-2130SS	87 lbs	WRSAD5-54-2130SS	84 lbs	WRS5-63-2130SS	91 lbs	WRSAD5-63-2130SS	86 lbs
21" x 36"	WRS5-54-2136SS	102 lbs	WRSAD5-54-2136SS	99 lbs	WRS5-63-2136SS	106 lbs	WRSAD5-63-2136SS	101 lbs
21" x 42"	WRS5-54-2142SS	117 lbs	WRSAD5-54-2142SS	114 lbs	WRS5-63-2142SS	121 lbs	WRSAD5-63-2142SS	116 lbs
21" x 48"	WRS5-54-2148SS	127 lbs	WRSAD5-54-2148SS	124 lbs	WRS5-63-2148SS	131 lbs	WRSAD5-63-2148SS	126 lbs
21" x 54"	WRS5-54-2154SS	137 lbs	WRSAD5-54-2154SS	134 lbs	WRS5-63-2154SS	141 lbs	WRSAD5-63-2154SS	136 lbs
21" x 60"	WRS5-54-2160SS	152 lbs	WRSAD5-54-2160SS	149 lbs	WRS5-63-2160SS	156 lbs	WRSAD5-63-2160SS	151 lbs
21" x 72"	WRS5-54-2172SS	162 lbs	WRSAD5-54-2172SS	159 lbs	WRS5-63-2172SS	166 lbs	WRSAD5-63-2172SS	161 lbs
24" x 24"	WRS5-54-2424SS	87 lbs	WRSAD5-54-2424SS	84 lbs	WRS5-63-2424SS	91 lbs	WRSAD5-63-2424SS	86 lbs
24" x 30"	WRS5-54-2430SS	97 lbs	WRSAD5-54-2430SS	94 lbs	WRS5-63-2430SS	101 lbs	WRSAD5-63-2430SS	96 lbs
24" x 36"	WRS5-54-2436SS	107 lbs	WRSAD5-54-2436SS	104 lbs	WRS5-63-2436SS	111 lbs	WRSAD5-63-2436SS	106 lbs
24" x 42"	WRS5-54-2442SS	122 lbs	WRSAD5-54-2442SS	119 lbs	WRS5-63-2442SS	126 lbs	WRSAD5-63-2442SS	121 lbs
24" x 48"	WRS5-54-2448SS	132 lbs	WRSAD5-54-2448SS	129 lbs	WRS5-63-2448SS	136 lbs	WRSAD5-63-2448SS	131 lbs
24" x 54"	WRS5-54-2454SS	152 lbs	WRSAD5-54-2454SS	149 lbs	WRS5-63-2454SS	156 lbs	WRSAD5-63-2454SS	151 lbs
24" x 60"	WRS5-54-2460SS	167 lbs	WRSAD5-54-2460SS	164 lbs	WRS5-63-2460SS	171 lbs	WRSAD5-63-2460SS	166 lbs
24" x 72"	WRS5-54-2472SS	182 lbs	WRSAD5-54-2472SS	179 lbs	WRS5-63-2472SS	186 lbs	WRSAD5-63-2472SS	181 lbs

Shelving units include 4 posts and 5 shelves. Add-On units include 2 posts, 5 shelves and 10 shelf clamps.

304 STAINLESS STEEL

Up to 400-600 lb. LOAD CAPACITY PER SHELF

SHELF W" x L"	74"H - STAINLESS SOLID SHELVING 5 SHELVES				86"H - STAINLESS SOLID SHELVING 5 SHELVES			
	STARTER KIT		ADD-ON KIT		STARTER KIT		ADD-ON KIT	
MODEL NO.	SHIP WGT	MODEL NO.	SHIP WGT	MODEL NO.	SHIP WGT	MODEL NO.	SHIP WGT	
14" x 36"	WRS5-74-1436SS	86 lbs	WRSAD5-74-1436SS	81 lbs	WRS5-86-1436SS	90 lbs	WRSAD5-86-1436SS	83 lbs
14" x 42"	WRS5-74-1442SS	91 lbs	WRSAD5-74-1442SS	86 lbs	WRS5-86-1442SS	95 lbs	WRSAD5-86-1442SS	88 lbs
14" x 48"	WRS5-74-1448SS	101 lbs	WRSAD5-74-1448SS	91 lbs	WRS5-86-1448SS	105 lbs	WRSAD5-86-1448SS	98 lbs
14" x 54"	WRS5-74-1454SS	116 lbs	WRSAD5-74-1454SS	111 lbs	WRS5-86-1454SS	120 lbs	WRSAD5-86-1454SS	113 lbs
14" x 60"	WRS5-74-1460SS	126 lbs	WRSAD5-74-1460SS	121 lbs	WRS5-86-1460SS	130 lbs	WRSAD5-86-1460SS	123 lbs
14" x 72"	WRS5-74-1472SS	146 lbs	WRSAD5-74-1472SS	141 lbs	WRS5-86-1472SS	150 lbs	WRSAD5-86-1472SS	143 lbs
18" x 24"	WRS5-74-1824SS	71 lbs	WRSAD5-74-1824SS	66 lbs	WRS5-86-1824SS	75 lbs	WRSAD5-86-1824SS	68 lbs
18" x 30"	WRS5-74-1830SS	86 lbs	WRSAD5-74-1830SS	81 lbs	WRS5-86-1830SS	90 lbs	WRSAD5-86-1830SS	83 lbs
18" x 36"	WRS5-74-1836SS	96 lbs	WRSAD5-74-1836SS	91 lbs	WRS5-86-1836SS	100 lbs	WRSAD5-86-1836SS	93 lbs
18" x 42"	WRS5-74-1842SS	106 lbs	WRSAD5-74-1842SS	101 lbs	WRS5-86-1842SS	110 lbs	WRSAD5-86-1842SS	103 lbs
18" x 48"	WRS5-74-1848SS	116 lbs	WRSAD5-74-1848SS	111 lbs	WRS5-86-1848SS	120 lbs	WRSAD5-86-1848SS	113 lbs
18" x 54"	WRS5-74-1854SS	126 lbs	WRSAD5-74-1854SS	121 lbs	WRS5-86-1854SS	130 lbs	WRSAD5-86-1854SS	123 lbs
18" x 60"	WRS5-74-1860SS	136 lbs	WRSAD5-74-1860SS	131 lbs	WRS5-86-1860SS	140 lbs	WRSAD5-86-1860SS	133 lbs
18" x 72"	WRS5-74-1872SS	151 lbs	WRSAD5-74-1872SS	151 lbs	WRS5-86-1872SS	155 lbs	WRSAD5-86-1872SS	153 lbs
21" x 24"	WRS5-74-2124SS	81 lbs	WRSAD5-74-2124SS	76 lbs	WRS5-86-2124SS	85 lbs	WRSAD5-86-2124SS	78 lbs
21" x 30"	WRS5-74-2130SS	91 lbs	WRSAD5-74-2130SS	86 lbs	WRS5-86-2130SS	95 lbs	WRSAD5-86-2130SS	88 lbs
21" x 36"	WRS5-74-2136SS	106 lbs	WRSAD5-74-2136SS	101 lbs	WRS5-86-2136SS	110 lbs	WRSAD5-86-2136SS	103 lbs
21" x 42"	WRS5-74-2142SS	121 lbs	WRSAD5-74-2142SS	116 lbs	WRS5-86-2142SS	125 lbs	WRSAD5-86-2142SS	118 lbs
21" x 48"	WRS5-74-2148SS	131 lbs	WRSAD5-74-2148SS	121 lbs	WRS5-86-2148SS	135 lbs	WRSAD5-86-2148SS	123 lbs
21" x 54"	WRS5-74-2154SS	141 lbs	WRSAD5-74-2154SS	136 lbs	WRS5-86-2154SS	145 lbs	WRSAD5-86-2154SS	138 lbs
21" x 60"	WRS5-74-2160SS	156 lbs	WRSAD5-74-2160SS	151 lbs	WRS5-86-2160SS	160 lbs	WRSAD5-86-2160SS	153 lbs
21" x 72"	WRS5-74-2172SS	166 lbs	WRSAD5-74-2172SS	186 lbs	WRS5-86-2172SS	170 lbs	WRSAD5-86-2172SS	188 lbs
24" x 24"	WRS5-74-2424SS	91 lbs	WRSAD5-74-2424SS	86 lbs	WRS5-86-2424SS	95 lbs	WRSAD5-86-2424SS	88 lbs
24" x 30"	WRS5-74-2430SS	101 lbs	WRSAD5-74-2430SS	96 lbs	WRS5-86-2430SS	105 lbs	WRSAD5-86-2430SS	98 lbs
24" x 36"	WRS5-74-2436SS	111 lbs	WRSAD5-74-2436SS	106 lbs	WRS5-86-2436SS	115 lbs	WRSAD5-86-2436SS	108 lbs
24" x 42"	WRS5-74-2442SS	126 lbs	WRSAD5-74-2442SS	121 lbs	WRS5-86-2442SS	130 lbs	WRSAD5-86-2442SS	123 lbs
24" x 48"	WRS5-74-2448SS	136 lbs	WRSAD5-74-2448SS	131 lbs	WRS5-86-2448SS	140 lbs	WRSAD5-86-2448SS	133 lbs
24" x 54"	WRS5-74-2454SS	156 lbs	WRSAD5-74-2454SS	151 lbs	WRS5-86-2454SS	160 lbs	WRSAD5-86-2454SS	153 lbs
24" x 60"	WRS5-74-2460SS	171 lbs	WRSAD5-74-2460SS	166 lbs	WRS5-86-2460SS	175 lbs	WRSAD5-86-2460SS	168 lbs
24" x 72"	WRS5-74-2472SS	186 lbs	WRSAD5-74-2472SS	181 lbs	WRS5-86-2472SS	205 lbs	WRSAD5-86-2472SS	198 lbs

Shelving units include 4 posts and 5 shelves. Add-On units include 2 posts, 5 shelves and 10 shelf clamps.



MOBILIZE YOUR SHELVING

DB - Donut Bumper
Non-marking donut bumper used to protect walls and help cushion impact.

WR-00HS (Mobile Kit)*
Set of four swivel 5" x 1-1/4" thermoplastic resin stainless steel casters with zerk grease fittings, 2 with brake. Can be used with all units shown. Up to 1,200 lb. load capacity. *Mobile kits recommended only for shelves 18" and deeper.



QSMC Shelf Clamp
Shelf Clamp eliminates 2 posts per shelving section. Two QSMC clamps are required per shelf. *Finish:* Aluminum (Sold individually)



5 Shelf Add-On Kits

Additional Add-On kits allow you to expand your Starter kit by sharing a set of posts. Configuration options include side to side, back to back and right angles (L-Shape). Add-on units consist of 5 shelves, 2 posts and 10 shelf clamps. Additional shelves and posts may be purchased separately, see chart on pg. 37. Units with Add-On kit cannot be made mobile. *Finish:* Stainless Steel

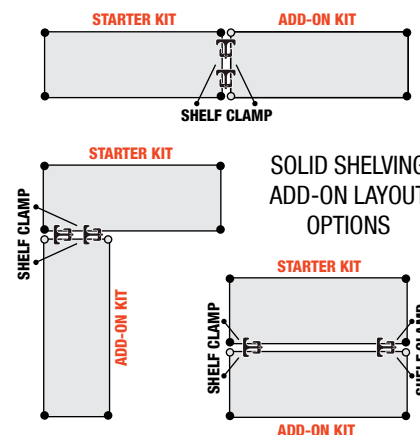

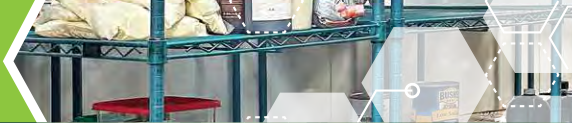

M1836C46



M1836CG46-5



M1836SG46

NEW
CHROME & EPOXY
WIRE SHELVES

DIMENSIONS W" x L" x H"	4 SHELF CARTS		5 SHELF CARTS	
	MODEL NO.	SHIP WGT	MODEL NO.	SHIP WGT
63"H - Post, 5" Stem Caster Carts				
18" x 36" x 69"	M1836C46	68 lbs	M1836C46-5	72 lbs
18" x 48" x 69"	M1848C46	76 lbs	M1848C46-5	84 lbs
18" x 60" x 69"	M1860C46	97 lbs	M1860C46-5	107 lbs
24" x 36" x 69"	M2436C46	80 lbs	M2436C46-5	87 lbs
24" x 48" x 69"	M2448C46	94 lbs	M2448C46-5	102 lbs
24" x 60" x 69"	M2460C46	116 lbs	M2460C46-5	127 lbs
74"H - Post, 5" Stem Caster Carts				
18" x 36" x 80"	M1836C47	70 lbs	M1836C47-5	74 lbs
18" x 48" x 80"	M1848C47	78 lbs	M1848C47-5	86 lbs
18" x 60" x 80"	M1860C47	99 lbs	M1860C47-5	109 lbs
24" x 36" x 80"	M2436C47	82 lbs	M2436C47-5	89 lbs
24" x 48" x 80"	M2448C47	96 lbs	M2448C47-5	104 lbs
24" x 60" x 80"	M2460C47	118 lbs	M2460C47-5	129 lbs

- GREEN EPOXY **P**
- GRAY EPOXY **GY**
- BLACK EPOXY **BK**

REPLACE "C" in Model No. to order Epoxy Finish ▶ Ex. **M1836P46**
M1836GY46
M1836BK46

CHROME WIRE AND
18 GAUGE SOLID
GALVANIZED STEEL SHELVES

DIMENSIONS W" x L" x H"	4 SHELF CARTS		5 SHELF CARTS	
	MODEL NO.	SHIP WGT	MODEL NO.	SHIP WGT
63"H - Post, 5" Stem Caster Carts				
18" x 36" x 69"	M1836CG46	68 lbs	M1836CG46-5	78 lbs
18" x 48" x 69"	M1848CG46	76 lbs	M1848CG46-5	90 lbs
18" x 60" x 69"	M1860CG46	97 lbs	M1860CG46-5	114 lbs
24" x 36" x 69"	M2436CG46	80 lbs	M2436CG46-5	93 lbs
24" x 48" x 69"	M2448CG46	94 lbs	M2448CG46-5	110 lbs
24" x 60" x 69"	M2460CG46	116 lbs	M2460CG46-5	137 lbs
74"H - Post, 5" Stem Caster Carts				
18" x 36" x 80"	M1836CG47	70 lbs	M1836CG47-5	80 lbs
18" x 48" x 80"	M1848CG47	78 lbs	M1848CG47-5	92 lbs
18" x 60" x 80"	M1860CG47	99 lbs	M1860CG47-5	116 lbs
24" x 36" x 80"	M2436CG47	82 lbs	M2436CG47-5	95 lbs
24" x 48" x 80"	M2448CG47	96 lbs	M2448CG47-5	112 lbs
24" x 60" x 80"	M2460CG47	118 lbs	M2460CG47-5	139 lbs

NEW
GALVANIZED & STAINLESS
SOLID SHELVES

DIMENSIONS W" x L" x H"	4 SHELF CARTS		5 SHELF CARTS	
	MODEL NO.	SHIP WGT	MODEL NO.	SHIP WGT
63"H - Post, 5" Stem Caster Carts				
18" x 36" x 69"	M1836SG46	86 lbs	M1836SG46-5	102 lbs
18" x 48" x 69"	M1848SG46	102 lbs	M1848SG46-5	122 lbs
18" x 60" x 69"	M1860SG46	118 lbs	M1860SG46-5	142 lbs
24" x 36" x 69"	M2436SG46	98 lbs	M2436SG46-5	117 lbs
24" x 48" x 69"	M2448SG46	102 lbs	M2448SG46-5	126 lbs
24" x 60" x 69"	M2460SG46	146 lbs	M2460SG46-5	177 lbs
74"H - Post, 5" Stem Caster Carts				
18" x 36" x 80"	M1836SG47	88 lbs	M1836SG47-5	104 lbs
18" x 48" x 80"	M1848SG47	104 lbs	M1848SG47-5	124 lbs
18" x 60" x 80"	M1860SG47	120 lbs	M1860SG47-5	144 lbs
24" x 36" x 80"	M2436SG47	100 lbs	M2436SG47-5	119 lbs
24" x 48" x 80"	M2448SG47	104 lbs	M2448SG47-5	128 lbs
24" x 60" x 80"	M2460SG47	148 lbs	M2460SG47-5	179 lbs

- STAINLESS **SS**

REPLACE "SG" in Model No. to order Stainless Steel Finish ▶ Ex. **M1836SS46**

Stem Caster Carts



4 or 5 Wire Shelf
Mobile Carts

Mobile wire stem caster carts add versatility and flexibility to any operation, creating a transport system. **Finishes:** Chrome, Green, Gray and Black Epoxy

- Supply and distribution
- Stock rotation
- Laundry
- Staging

Each unit consists of:

- 4 - posts
- 4 or 5 - wire shelves
- 4 - donut bumpers
- 4 - 5" thermoplastic resin casters, 2 with brakes

3 or 4 Wire/1 Solid Shelf
Mobile Carts

Stem caster cart with solid bottom shelf. The unique combination of wire and solid shelves allows for air circulation and high visibility. The solid shelf in the bottom position prevents dust and dirt to rise and contains spillage.

Each unit consists of:

- 4 - posts
- 3 or 4 - wire shelves
- 1 - solid shelf
- 4 - donut bumpers
- 4 - 5" thermoplastic resin casters, 2 with brakes

Up to 1,200 lb.
MOBILE LOAD
CAPACITY

4 or 5 Solid Shelf
Mobile Carts

Stem caster solid shelf cart is an easy way to transport tools and inventories. **Finishes:** Galvanized Steel and Stainless Steel

Each unit consists of:

- 4 - posts
- 4 or 5 - solid shelves
- 4 - donut bumpers
- 4 - 5" thermoplastic resin casters, 2 with brakes



Enclosure Carts



Enclosure carts are an effective way to keep contents from moving or falling off during transportation.

Enclosure carts using rods and tabs are adaptable to any shelf position.

Enclosure dolly base truck using rods and tabs allows for heavier load transport. The rods and tabs act as a perimeter to retain product.

For additional shelves, see **pg. 24**.

Each units consist of:

- 4 - posts
- 4 or 5 - wire shelves
- 4, 5 or 6 - rods and tabs kits

Mobile unit also includes:

- 4 - 5" swivel thermoplastic resin casters, 2 with brakes
- 4 - donut bumpers

Dolly Base unit also includes:

- 1 - dolly base
- 4 - plate thermoplastic resin casters (2 rigid and 2 swivel with brake)

**COMPLETE
CARTS INCLUDE
CASTER KIT
FOR MOBILITY**

**Up to 1,200 lb.
MOBILE LOAD
CAPACITY**



M1836C46RE



MD1836C46RE-5

3 SIDED, 4 OR 5 WIRE SHELF CART WITH RODS AND TABS

DIMENSIONS W" x L" x H"	4 SHELF CARTS		5 SHELF CARTS	
	MODEL NO.	SHIP WGT	MODEL NO.	SHIP WGT
63"H - Post, Cart with Rods and Tabs				
18" x 36" x 69"	M1836C46RE	74 lbs	M1836C46RE-5	84 lbs
18" x 48" x 69"	M1848C46RE	84 lbs	M1848C46RE-5	98 lbs
18" x 60" x 69"	M1860C46RE	100 lbs	M1860C46RE-5	117 lbs
24" x 36" x 69"	M2436C46RE	88 lbs	M2436C46RE-5	101 lbs
24" x 48" x 69"	M2448C46RE	104 lbs	M2448C46RE-5	120 lbs
24" x 60" x 69"	M2460C46RE	124 lbs	M2460C46RE-5	145 lbs
74"H - Post, Cart with Rods and Tabs				
18" x 36" x 80"	M1836C47RE	80 lbs	M1836C47RE-5	90 lbs
18" x 48" x 80"	M1848C47RE	92 lbs	M1848C47RE-5	106 lbs
18" x 60" x 80"	M1860C47RE	104 lbs	M1860C47RE-5	121 lbs
24" x 36" x 80"	M2436C47RE	94 lbs	M2436C47RE-5	107 lbs
24" x 48" x 80"	M2448C47RE	112 lbs	M2448C47RE-5	128 lbs
24" x 60" x 80"	M2460C47RE	132 lbs	M2460C47RE-5	153 lbs

**CHROME WIRE
SHELVES**

DOLLY BASE 3 SIDED, 4 OR 5 WIRE SHELF CART WITH RODS AND TABS

DIMENSIONS W" x L" x H"	4 SHELF CARTS		5 SHELF CARTS	
	MODEL NO.	SHIP WGT	MODEL NO.	SHIP WGT
63"H - Post, Dolly Base Carts with Rods and Tabs				
18" x 36" x 70"	MD1836C46RE	86 lbs	MD1836C46RE-5	96 lbs
18" x 48" x 70"	MD1848C46RE	96 lbs	MD1848C46RE-5	110 lbs
18" x 60" x 70"	MD1860C46RE	124 lbs	MD1860C46RE-5	141 lbs
24" x 36" x 70"	MD2436C46RE	113 lbs	MD2436C46RE-5	126 lbs
24" x 48" x 70"	MD2448C46RE	121 lbs	MD2448C46RE-5	137 lbs
24" x 60" x 70"	MD2460C46RE	144 lbs	MD2460C46RE-5	165 lbs
74"H - Post, Dolly Base Carts with Rods and Tabs				
18" x 36" x 81"	MD1836C47RE	92 lbs	MD1836C47RE-5	102 lbs
18" x 48" x 81"	MD1848C47RE	106 lbs	MD1848C47RE-5	120 lbs
18" x 60" x 81"	MD1860C47RE	120 lbs	MD1860C47RE-5	137 lbs
24" x 36" x 81"	MD2436C47RE	108 lbs	MD2436C47RE-5	121 lbs
24" x 48" x 81"	MD2448C47RE	129 lbs	MD2448C47RE-5	145 lbs
24" x 60" x 81"	MD2460C47RE	152 lbs	MD2460C47RE-5	173 lbs

Rods & Tabs

Rods and tabs represent an economical, alternate solution for enclosure on backs and sides of mobile and stationary units.

Each kit includes:

- 3 - rods
- 9 - front/back tabs
- 9 - side/solid shelf tabs.

MODEL NO.	DESCRIPTION	SHIP WGT
Rods & Tabs		
52RT	3 - 52" Rods with Tabs	1 lb
61RT	3 - 61" Rods with Tabs	1 lb
72RT	3 - 72" Rods with Tabs	2 lbs
84RT	3 - 84" Rods with Tabs	2 lbs



QSRT
Side or Solid
Shelf Tab



QAT
Front or Back
Tab

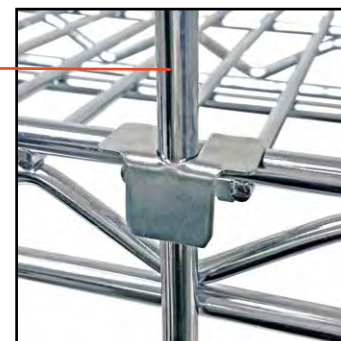

ROD



3 SIDED STEM CASTER WIRE SHELF CART WITH 3 OR 4 WIRE SHELVES AND 1 SOLID SHELF WITH RODS AND TABS

DIMENSIONS W" x L" x H"	4 SHELF CARTS		5 SHELF CARTS	
	MODEL NO.	SHIP WGT	MODEL NO.	SHIP WGT
63"H - Post, Cart with Rods and Tabs				
18" x 36" x 69"	M1836CG46RE	83 lbs	M1836CG46RE-5	93 lbs
18" x 48" x 69"	M1848CG46RE	94 lbs	M1848CG46RE-5	108 lbs
18" x 60" x 69"	M1860CG46RE	114 lbs	M1860CG46RE-5	131 lbs
24" x 36" x 69"	M2436CG46RE	96 lbs	M2436CG46RE-5	109 lbs
24" x 48" x 69"	M2448CG46RE	112 lbs	M2448CG46RE-5	128 lbs
24" x 60" x 69"	M2460CG46RE	136 lbs	M2460CG46RE-5	157 lbs
74"H - Post, Cart with Rods and Tabs				
18" x 36" x 80"	M1836CG47RE	89 lbs	M1836CG47RE-5	99 lbs
18" x 48" x 80"	M1848CG47RE	101 lbs	M1848CG47RE-5	115 lbs
18" x 60" x 80"	M1860CG47RE	123 lbs	M1860CG47RE-5	140 lbs
24" x 36" x 80"	M2436CG47RE	102 lbs	M2436CG47RE-5	115 lbs
24" x 48" x 80"	M2448CG47RE	119 lbs	M2448CG47RE-5	135 lbs
24" x 60" x 80"	M2460CG47RE	144 lbs	M2460CG47RE-5	166 lbs

CHROME WIRE AND 18 GAUGE SOLID GALVANIZED STEEL SHELVES

DOLLY BASE 3 SIDED WIRE SHELF CART WITH 3 OR 4 WIRE SHELVES AND 1 SOLID SHELF WITH RODS AND TABS

DIMENSIONS W" x L" x H"	4 SHELF CARTS		5 SHELF CARTS	
	MODEL NO.	SHIP WGT	MODEL NO.	SHIP WGT
63"H - Post, Dolly Base Carts with Rods and Tabs				
18" x 36" x 70"	MD1836CG46RE	93 lbs	MD1836CG46RE-5	102 lbs
18" x 48" x 70"	MD1848CG46RE	106 lbs	MD1848CG46RE-5	116 lbs
18" x 60" x 70"	MD1860CG46RE	128 lbs	MD1860CG46RE-5	147 lbs
24" x 36" x 70"	MD2436CG46RE	109 lbs	MD2436CG46RE-5	132 lbs
24" x 48" x 70"	MD2448CG46RE	127 lbs	MD2448CG46RE-5	145 lbs
24" x 60" x 70"	MD2460CG46RE	154 lbs	MD2460CG46RE-5	175 lbs
74"H - Post, Dolly Base Carts with Rods and Tabs				
18" x 36" x 81"	MD1836CG47RE	99 lbs	MD1836CG47RE-5	108 lbs
18" x 48" x 81"	MD1848CG47RE	113 lbs	MD1848CG47RE-5	126 lbs
18" x 60" x 81"	MD1860CG47RE	137 lbs	MD1860CG47RE-5	143 lbs
24" x 36" x 81"	MD2436CG47RE	115 lbs	MD2436CG47RE-5	127 lbs
24" x 48" x 81"	MD2448CG47RE	134 lbs	MD2448CG47RE-5	153 lbs
24" x 60" x 81"	MD2460CG47RE	163 lbs	MD2460CG47RE-5	183 lbs



M1836CG46RE



MD1836CG46RE-5

Enclosure Carts **NSF**

Enclosure carts are an effective way to keep contents from moving or falling off during transportation.

Enclosure carts using rods and tabs are adaptable to any shelf position.

Enclosure dolly base truck using rods and tabs allows for heavier load transport. The rods and tabs act as a perimeter to retain product.

For additional shelves, see *pg. 24*.

- Each units consist of:*
- 4 - posts
 - 3 or 4 - wire shelves
 - 1 - solid shelf
 - 4, 5 or 6 - rods and tabs kits

- Mobile unit also includes:*
- 4 - 5" swivel thermoplastic resin casters, 2 with brakes
 - 4 - donut bumpers

- Dolly Base unit also includes:*
- 1 - dolly base
 - 4 - plate thermoplastic resin casters (2 rigid and 2 swivel with brake)

COMPLETE CARTS INCLUDE CASTER KIT FOR MOBILITY

Up to 1,200 lb. MOBILE LOAD CAPACITY

NYLON FABRIC OR CLEAR VINYL CART COVERS AVAILABLE

See *pg. 46*



WHITE NYLON

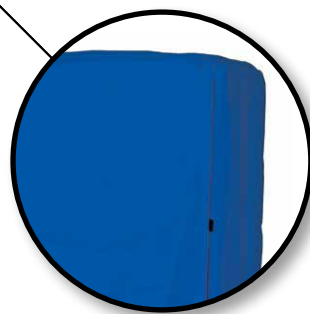

BLUE NYLON



CLEAR VINYL

CART COVERS
Protect against pilferage, airborne dust, moisture, and other contaminants



Enclosure Carts



Finishes: Chrome and Green Epoxy

Each unit consists of:

- 4 - posts
- 4 or 5 - wire shelves
- 4 - enclosure panels
- 4 - 5" swivel thermoplastic resin casters, 2 with brakes
- 4 - donut bumpers

NYLON FABRIC OR CLEAR VINYL CART COVERS AVAILABLE

See pg. 46



BLUE NYLON CART COVER

Protect against pilferage, airborne dust, moisture and other contaminants

Each units consist of:

- 4 - posts
- 3 or 4 - wire shelves
- 1 - solid shelf
- 4 or 5 - enclosure panels

Mobile unit also includes:

- 4 - 5" swivel thermoplastic resin casters, 2 with brakes
- 4 - donut bumpers

Dolly Base unit also includes:

- 1 - dolly base
- 4 - plate thermoplastic resin casters (2 rigid and 2 swivel with brake)

Add SUFFIX shown below to any Model No. to add Clear Label Holder package

- ▶ Ex. **M2436C46E-LH33C**
- Ex. **M2436C46E-5LH33C**

- 36" L ENCLOSURE CARTS -LH33C
- 48" L ENCLOSURE CARTS -LH45C
- 60" L ENCLOSURE CARTS -LH57C

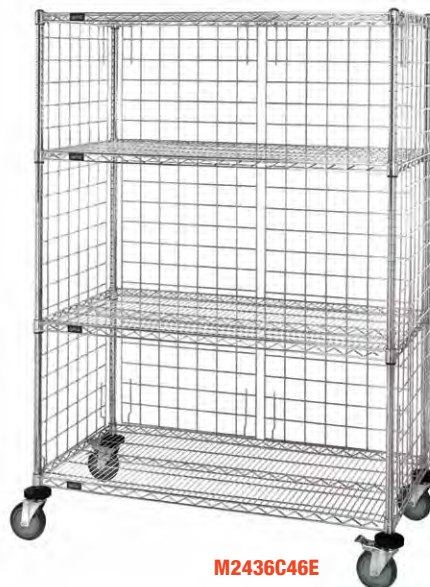

M2436C46E



WRCS4-63-2460EP-5



WRDBS4-63-2460EP

NEW

CHROME & EPOXY WIRE SHELVES

3 SIDED, 4 OR 5 WIRE SHELF CART WITH ENCLOSURE PANELS

DIMENSIONS W" x L" x H"	4 SHELF CARTS		5 SHELF CARTS	
	MODEL NO.	SHIP WGT	MODEL NO.	SHIP WGT
63"H - Post, Cart with Enclosure Panels				
24" x 36" x 69"	M2436C46E	145 lbs	M2436C46E-5	158 lbs
24" x 48" x 69"	M2448C46E	179 lbs	M2448C46E-5	195 lbs
24" x 60" x 69"	M2460C46E	197 lbs	M2460C46E-5	218 lbs

• **GREEN EPOXY P**

REPLACE "C" in Model No. to order Epoxy Finish ▶ Ex. **M2436P46E**

COMPLETE CARTS INCLUDE CASTER KIT FOR MOBILITY

Up to 1,200 lb. MOBILE LOAD CAPACITY

3 SIDED STEM CASTER ENCLOSURE CART WITH 3 OR 4 WIRE SHELVES AND 1 SOLID SHELF WITH ENCLOSURE PANELS

DIMENSIONS W" x L" x H"	4 SHELF CARTS		5 SHELF CARTS	
	MODEL NO.	SHIP WGT	MODEL NO.	SHIP WGT
63"H - Post, Cart with Solid Bottom Shelf and Enclosure Panels				
24" x 36" x 69"	WRCS4-63-2436EP	113 lbs	WRCS4-63-2436EP-5	126 lbs
24" x 48" x 69"	WRCS4-63-2448EP	131 lbs	WRCS4-63-2448EP-5	147 lbs
24" x 60" x 69"	WRCS4-63-2460EP	158 lbs	WRCS4-63-2460EP-5	179 lbs
74"H - Post, Cart with Solid Bottom Shelf and Enclosure Panels				
24" x 36" x 80"	WRCS4-74-2436EP	113 lbs	WRCS4-74-2436EP-5	126 lbs
24" x 48" x 80"	WRCS4-74-2448EP	131 lbs	WRCS4-74-2448EP-5	147 lbs
24" x 60" x 80"	WRCS4-74-2460EP	158 lbs	WRCS4-74-2460EP-5	179 lbs

CHROME WIRE AND 18 GAUGE SOLID GALVANIZED STEEL SHELVES

3 SIDED DOLLY BASE ENCLOSURE CART WITH 3 OR 4 WIRE SHELVES AND 1 SOLID SHELF WITH ENCLOSURE PANELS

DIMENSIONS W" x L" x H"	4 SHELF CARTS		5 SHELF CARTS	
	MODEL NO.	SHIP WGT	MODEL NO.	SHIP WGT
63"H - Post, Dolly Base Cart with Solid Bottom Shelf and Enclosure Panels				
24" x 36" x 70"	WRDBS4-63-2436EP	124 lbs	WRDBS4-63-2436EP-5	137 lbs
24" x 48" x 70"	WRDBS4-63-2448EP	142 lbs	WRDBS4-63-2448EP-5	158 lbs
24" x 60" x 70"	WRDBS4-63-2460EP	169 lbs	WRDBS4-63-2460EP-5	190 lbs
74"H - Post, Dolly Base Cart with Solid Bottom Shelf and Enclosure Panels				
24" x 36" x 81"	WRDBS4-74-2436EP	124 lbs	WRDBS4-74-2436EP-5	137 lbs
24" x 48" x 81"	WRDBS4-74-2448EP	142 lbs	WRDBS4-74-2448EP-5	158 lbs
24" x 60" x 81"	WRDBS4-74-2460EP	169 lbs	WRDBS4-74-2460EP-5	190 lbs



Cart Covers

Protect against pilferage, airborne dust, water, and other contaminants. Velcro and zipper flap are available in clear-vinyl and blue and white denier nylon fabric. Clear vinyl is 10 gauge. Blue and white nylon fabric is 400 Denier. Specify zipper or velcro for closure.

CART COVERS OPTIONS AVAILABLE

- Custom sizes
- Hand openings
- Handle holes/slots
- Bottom tie tapes (*attach to posts*)
- Extra velcro strips
- Double flap
- Clear front flap
- Metal grommets
- 9" x 12" pocket/document holder
- Custom logos

TO ORDER:

1. Choose size
2. Select color:
Clear Vinyl add suffix CV
Blue Nylon add suffix BN
White Nylon add suffix WN
3. Choose Zipper or Velcro

COVERS PROTECT AGAINST PILFERAGE, AIRBORNE DUST, MOISTURE AND OTHER CONTAMINANTS

CUSTOM SIZES AND ADDITIONAL COLORS ALONG WITH ESD/CONDUCTIVE MATERIAL AVAILABLE

call for details



CLEAR VINYL



BLUE NYLON



WHITE NYLON

63"H - CART COVER				74"H - CART COVER			
DIMENSIONS W" x L" x H"	SHIP WGT	400 DENIER MODEL NO.	CLEAR VINYL MODEL NO.	DIMENSIONS W" x L" x H"	SHIP WGT	400 DENIER MODEL NO.	CLEAR VINYL MODEL NO.
18" x 36" x 63"	3 lbs	CC183663	CC183663CV	18" x 36" x 74"	4 lbs	CC183674	CC183674CV
18" x 48" x 63"	4 lbs	CC184863	CC184863CV	18" x 48" x 74"	5 lbs	CC184874	CC184874CV
18" x 60" x 63"	5 lbs	CC186063	CC186063CV	18" x 60" x 74"	6 lbs	CC186074	CC186074CV
18" x 72" x 63"	6 lbs	CC187263	CC187263CV	18" x 72" x 74"	7 lbs	CC187274	CC187274CV
24" x 36" x 63"	3 lbs	CC243663	CC243663CV	24" x 36" x 74"	4 lbs	CC243674	CC243674CV
24" x 48" x 63"	4 lbs	CC244863	CC244863CV	24" x 48" x 74"	5 lbs	CC244874	CC244874CV
24" x 60" x 63"	5 lbs	CC246063	CC246063CV	24" x 60" x 74"	6 lbs	CC246074	CC246074CV
24" x 72" x 63"	6 lbs	CC247263	CC247263CV	24" x 72" x 74"	7 lbs	CC247274	CC247274CV



NOW 3 FINISHES AVAILABLE ▶

EXPANDED 1 BOX WIRE SHELVING OFFERING
NOW also available in **BLACK** and **GREEN Epoxy**



CONVENIENT 1 BOX WIRE SHELVING UNIT
Chrome Finish



CONVENIENT 1 BOX WIRE SHELVING UNIT
Black Epoxy Finish



CONVENIENT 1 BOX WIRE SHELVING UNIT
Green Epoxy Finish

Convenient 1 Box Wire Shelving Units

Super competitive cost. All packed in 1 box for super easy inventory control, shipping, and receiving. Four shelf configuration.

FINISHES: ◊ CHROME ◊ GREEN EPOXY P ◊ BLACK EPOXY BK

Add SUFFIX to Model No. to order Epoxy Finish ▶ Ex. **RWR72-1830LDP**
RWR72-1830LDBK

MODEL NO.	DIMENSIONS W" x L" x H"	SHIP WGT
Chrome One Box Shelving		
RWR72-1830LD	18" x 30" x 72"	35 lbs
RWR72-1836LD	18" x 36" x 72"	38 lbs
RWR72-1842LD	18" x 42" x 72"	42 lbs
RWR72-1848LD	18" x 48" x 72"	46 lbs
RWR72-2430LD	24" x 30" x 72"	40 lbs
RWR72-2436LD	24" x 36" x 72"	46 lbs
RWR72-2442LD	24" x 42" x 72"	51 lbs
RWR72-2448LD	24" x 48" x 72"	56 lbs



Up to 300 lb.
LOAD CAPACITY PER SHELF

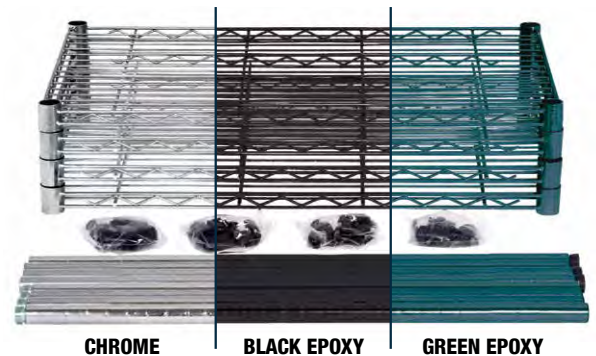

CHROME | BLACK EPOXY | GREEN EPOXY

PERFORMANCE FEATURES:

- Up to 300 lb. load capacity per shelf (evenly distributed)
- Assembles in minutes
- Wire design allows for air circulation and minimal dust buildup
- Shelves easily adjust on 1" centers to your exact needs
- Ideal storage solution for any commercial, office, warehouse or home application
- Includes posts, shelves, and all needed hardware - all in one box
- No tools required



SUPER LOW PRICE!

▶ **SINGLE BOX SHIPMENT**

▶ **SUPER LOW TRANSIT COST**



MOBILIZE YOUR SHELVING

W-PLI - Post Insert
Each unit will require one 4-pack.

WR-3 (Mobile Kit)
Set of four 3" polyurethane casters, all with brakes. Can be used with all units shown. Up to 800 lb. load capacity.





STORAGE

RETAIL UNITS - CONVENIENT 1 BOX MILLENIA SHELVING

1 Box Millenia Vented Shelf Units



Vented shelves allows for storage from small to large items. Open grid surface allows for air circulation and minimal dust buildup. All vented complete shelf units consist of 4 shelves and 4 posts. Mobilize starter kit shelving unit using optional mobile kit. **Color:** Gray

MODEL NO.	DIMENSIONS W" x L" x H"	SHIP WGT
Millenia One Box Shelving		
QP182474VS-4	18" x 24" x 74"	35 lbs
QP183074VS-4	18" x 30" x 74"	39 lbs
QP183674VS-4	18" x 36" x 74"	43 lbs
QP184274VS-4	18" x 42" x 74"	46 lbs
QP184874VS-4	18" x 48" x 74"	50 lbs
QP212474VS-4	21" x 24" x 74"	36 lbs
QP213074VS-4	21" x 30" x 74"	41 lbs
QP213674VS-4	21" x 36" x 74"	45 lbs
QP214274VS-4	21" x 42" x 74"	49 lbs
QP214874VS-4	21" x 48" x 74"	54 lbs
QP242474VS-4	24" x 24" x 74"	43 lbs
QP243074VS-4	24" x 30" x 74"	48 lbs
QP243674VS-4	24" x 36" x 74"	54 lbs
QP244274VS-4	24" x 42" x 74"	59 lbs
QP244874VS-4	24" x 48" x 74"	65 lbs



OPTIONAL MOBILE KIT

QPPSC-5S

Includes four 5"x1-1/4" Polymer swivel casters, 2 with brake and four donut bumpers. Up to 800 lb. mobile load capacity (evenly distributed)



4 SHELF UNIT

PERFORMANCE FEATURES:

NSF

- Lifetime limited warranty against rust and corrosion
- Up to 1,000 lb. load capacity per shelf
- Extremely versatile and suitable for wet, humid and dry environments
- Polymer composition makes it resistant to abrasive chemicals and salt water with built-in antimicrobial protection
- Shelves can be adjusted on 1" increments with no special tool required
- NSF Approved



SUPER LOW PRICE

SUPER LOW TRANSIT COST

SINGLE BOX SHIPMENT

INSIDE EACH SINGLE BOX UNIT

- 4 - vented shelves
- 4 - posts (6 pieces each)
- 4 - floor adapters
- 4 - post caps
- 1 - pack (16 sets of split sleeves)
- 1 - pack (16 gussets)



POST



CAP



SPLIT SLEEVES



FLOOR ADAPTER



GUSSET



VENTED SHELF

Up to **1,000 lb.** LOAD CAPACITY PER SHELF

1 Box Polymer Wire Shelving Units

4 shelf configuration. Super competitive cost. All packed in 1 box for super easy inventory control, shipping, and receiving. **Finish:** Proform Green Epoxy

MODEL NO.	DIMENSIONS W" x L" x H"	SHIP WGT
Proform Green Epoxy One Box Shelving		
WR74-1830WPM	18" x 30" x 74"	48 lbs
WR74-1836WPM	18" x 36" x 74"	56 lbs
WR74-1842WPM	18" x 42" x 74"	64 lbs
WR74-1848WPM	18" x 48" x 74"	68 lbs
WR74-2130WPM	21" x 30" x 74"	56 lbs
WR74-2136WPM	21" x 36" x 74"	64 lbs
WR74-2142WPM	21" x 42" x 74"	68 lbs
WR74-2148WPM	21" x 48" x 74"	76 lbs
WR74-2430WPM	24" x 30" x 74"	64 lbs
WR74-2436WPM	24" x 36" x 74"	68 lbs
WR74-2442WPM	24" x 42" x 74"	72 lbs
WR74-2448WPM	24" x 48" x 74"	80 lbs



MOBILIZE YOUR WIRE SHELVING

DB - Donut Bumper
Non-marking donut bumper used to protect walls and help cushion impact.

WR-00H (Mobile Kit)
Set of four swivel thermoplastic resin 5" x 1-1/4" casters, two with brakes. Can be used with all units shown. 1,200 lb. load capacity.

For additional Caster options See **pg. 33**



4 SHELF UNIT
Proform Green Epoxy Finish

PERFORMANCE FEATURES:



- 15 year limited warranty on Epoxy, Lifetime limited warranty on plastic
- Up to 600-800 lb. load capacity per shelf
- Smooth, vented, open grid surface allows for air circulation and minimal dust buildup
- Shelf plates are easily removable and dishwasher safe
- NSF Approved
- Antimicrobial
- Resistant against corrosion



SUPER LOW PRICE

SUPER LOW TRANSIT COST

SINGLE BOX SHIPMENT

- INSIDE EACH SINGLE BOX UNIT**
- 4 - posts (2 or 3 pieces each)
 - 4 - wire frames
 - 4 - plastic wire mats (2 or 3 pieces each)
 - 4 - packs of split sleeves

Up to 600-800 lb.
LOAD CAPACITY PER SHELF





Security Units

Stationary and Mobile Units prevent pilferage while allowing high visibility of contents at all times. All side and back panels are heavy gauge wire construction and are manufactured of all-welded heavy-duty 1/4" diameter wire on 2" x 2" centers. Assembly is quick and easy. **Finishes:** Chrome and Proform Green Epoxy

WANT TO SECURE YOUR EXISTING SHELVING UNITS?



Thick wire gauge ensures strong and dependable security yet easy visibility



2436-63SECP-2

NYLON FABRIC OR CLEAR VINYL UNIT COVERS AVAILABLE FOR ALL SECURITY UNITS See pg. 46

Stationary Security Units

Each unit consists of:

- 4 - posts
- 2 - wire shelves (for top and bottom)
- 1 - security panel set (includes back and sides)
- 1 - pair security panel doors

MODEL NO.	DIMENSIONS W" x L" x H"	SHIP WGT
Stationary Security Units		
1836-63SEC	18" x 36" x 63"	145 lbs
1848-63SEC	18" x 48" x 63"	172 lbs
1860-63SEC	18" x 60" x 63"	204 lbs
2136-63SEC	21" x 36" x 63"	155 lbs
2148-63SEC	21" x 48" x 63"	162 lbs
2160-63SEC	21" x 60" x 63"	214 lbs
2436-63SEC	24" x 36" x 63"	165 lbs
2448-63SEC	24" x 48" x 63"	192 lbs
2460-63SEC	24" x 60" x 63"	224 lbs

ADD SUFFIX "P" TO MODEL NO. TO ORDER GREEN EPOXY FINISH

Ex. 2436-63SECP

Intermediate shelves can be purchased separately for all security units see pg. 24. To order unit with 2 intermediate shelves included, add -2 to the end of each model no.

Ex. 2436-63SEC-2
2436-63SECP-2

Security Panel Doors

Each door set has left and right panel with 4 hinge bars. Assembly is quick and easy and adapts to the appropriate shelf size, with standard post of 63" high.

CHROME MODEL NO.	GREEN EPOXY MODEL NO.	DIMENSIONS W" x L" x H"	SHIP WGT
NEW SIZES			
Security Panel Door Set with Hinges			
SD36-18C	SD36-18P	18" x 36" x 60"	64 lbs
SD48-18C	SD48-18P	18" x 48" x 60"	76 lbs
SD60-18C	SD60-18P	18" x 60" x 60"	88 lbs
SD36-21C	SD36-21P	21" x 36" x 60"	66 lbs
SD48-21C	SD48-21P	21" x 48" x 60"	78 lbs
SD60-21C	SD60-21P	21" x 60" x 60"	90 lbs
SD36-24C	SD36-24P	24" x 36" x 60"	67 lbs
SD48-24C	SD48-24P	24" x 48" x 60"	79 lbs
SD60-24C	SD60-24P	24" x 60" x 60"	91 lbs



DOOR TOP SECURITY

DOOR MIDDLE SECURITY

DOOR BOTTOM SECURITY



M2436-69SEC

Stem Caster Security Carts

Mobility adds flexibility to a unit and is beneficial in all types of operations.

Each unit consists of:

- 4 - posts
- 2 - wire shelves (for top and bottom)
- 1 - security panel set (includes back and sides)
- 1 - pair security panel doors
- 4 - 5" thermoplastic resin casters, 2 with brake
- 4 - donut bumpers

MODEL NO.	DIMENSIONS W" x L" x H"	SHIP WGT
Stem Caster Security Carts		
M1836-69SEC	18" x 36" x 69"	153 lbs
M1848-69SEC	18" x 48" x 69"	180 lbs
M1860-69SEC	18" x 60" x 69"	212 lbs
M2136-69SEC	21" x 36" x 69"	163 lbs
M2148-69SEC	21" x 48" x 69"	190 lbs
M2160-69SEC	21" x 60" x 69"	222 lbs
M2436-69SEC	24" x 36" x 69"	173 lbs
M2448-69SEC	24" x 48" x 69"	200 lbs
M2460-69SEC	24" x 60" x 69"	232 lbs

Security Panel Sets

Panels allow maximum security for standard shelving units. Panels are fabricated from all-welded wire and include joined back portion and two side portions.

CHROME MODEL NO.	GREEN EPOXY MODEL NO.	DIMENSIONS W" x L" x H"	SHIP WGT
NEW SIZES			
Security Enclosure Panel Set			
183660EPC	183660EPP	18" x 36" x 60"	60 lbs
184860EPC	184860EPP	18" x 48" x 60"	67 lbs
186060EPC	186060EPP	18" x 60" x 60"	77 lbs
213660EPC	213660EPP	21" x 36" x 60"	64 lbs
214860EPC	214860EPP	21" x 48" x 60"	71 lbs
216060EPC	216060EPP	21" x 60" x 60"	81 lbs
243660EPC	243660EPP	24" x 36" x 60"	70 lbs
244860EPC	244860EPP	24" x 48" x 60"	80 lbs
246060EPC	246060EPP	24" x 60" x 60"	90 lbs

Up to 1,200 lb. MOBILE LOAD CAPACITY



MD2436-70SEC

Dolly Base Security Carts

Dollies can add stability and support in heavy-duty load applications.

Each unit consists of:

- 4 - posts
- 2 - wire shelves (for top and bottom)
- 1 - security panel set (includes back and sides)
- 1 - pair security panel doors
- 1 - dolly base
- 4 - plate thermoplastic resin casters (2 rigid and 2 swivel with brake)

MODEL NO.	DIMENSIONS W" x L" x H"	SHIP WGT
Dolly Base Security Carts		
MD1836-70SEC	18" x 36" x 70"	165 lbs
MD1848-70SEC	18" x 48" x 70"	194 lbs
MD1860-70SEC	18" x 60" x 70"	228 lbs
MD2436-70SEC	24" x 36" x 70"	186 lbs
MD2448-70SEC	24" x 48" x 70"	215 lbs
MD2460-70SEC	24" x 60" x 70"	250 lbs



Corner Wire Shelving



When in need of more storage space, Quantum Corner Wire Shelving is the answer. It's great for any corner area. It is versatile and durable, it is easy to assemble. Each shelf holds up to 700 lbs., evenly distributed. This versatile storage option will help your rooms stay neat, organized and maximized.

Finishes: Chrome and Proform Green Epoxy

REPLACE SUFFIX "C" AT THE END OF MODEL NO. WITH "P" TO ORDER GREEN EPOXY FINISH

Ex. 1836CRNP
WR74-1836CRNP
WR74-1836CRNP-5

MODEL NO.	SHELF DIMENSIONS A" x B" x C" x D" x E"	SHIP WGT
Corner Wire Shelves		
1836CRNC	37-7/8" x 50-1/4" x 36" x 18" x 27"	16 lbs
2442CRNC	46" x 58-1/2" x 41-3/4" x 24" x 26-1/2"	21 lbs
74"H - Corner Wire Shelving 4 Shelf System		
WR74-1836CRNC	37-7/8" x 50-1/4" x 36" x 18" x 27"	80 lbs
WR74-2442CRNC	46" x 58-1/2" x 41-3/4" x 24" x 26-1/2"	100 lbs
74"H - Corner Wire Shelving 5 Shelf System		
WR74-1836CRNC-5	37-7/8" x 50-1/4" x 36" x 18" x 27"	96 lbs
WR74-2442CRNC-5	46" x 58-1/2" x 41-3/4" x 24" x 26-1/2"	121 lbs

MOBILIZE YOUR SHELVING

DB - Donut Bumper
Non-marking donut bumper used to protect walls and help cushion impact.



WR-00H-5 (Mobile Kit)

Set of five swivel thermoplastic resin 5" x 1-1/4" casters, two with brakes. Can be used with all units shown. 1,500 lb. load capacity.



1836CRNP
Corner Wire Shelf Proform Green Epoxy Finish
(Use with 18" deep wire shelving)

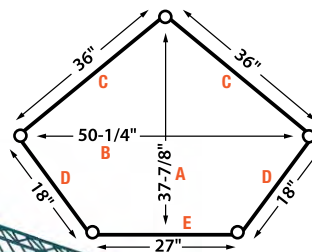

Up to 700 lb.
LOAD CAPACITY
PER SHELF



2442CRNP
Corner Wire Shelf Proform Green Epoxy Finish
(Use with 24" deep wire shelving)

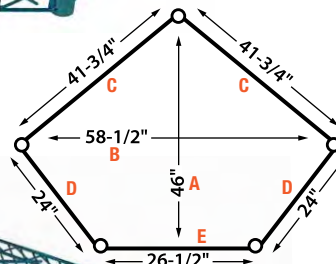

PERFORMANCE FEATURES:

- Up to 700 lb. load capacity per shelf
- Easy assembly with no tools needed
- Compatible with 18" and 24" deep wire shelving add-on units
- Shelves easily adjust on 1" centers to your exact needs
- Ideal storage solution for any commercial, office, warehouse or home application
- Bright chrome or green epoxy finish

CORNER WIRE SHELVING & ADD-ON LAYOUT OPTIONS

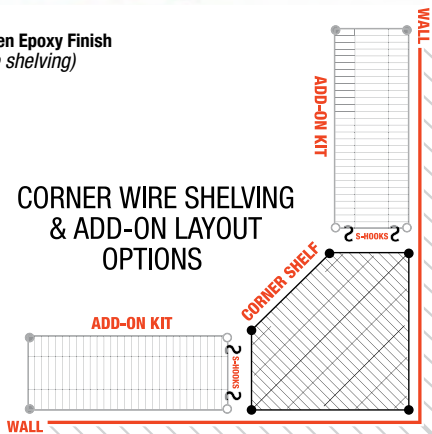

4 SHELF UNIT
Proform Green Epoxy Finish

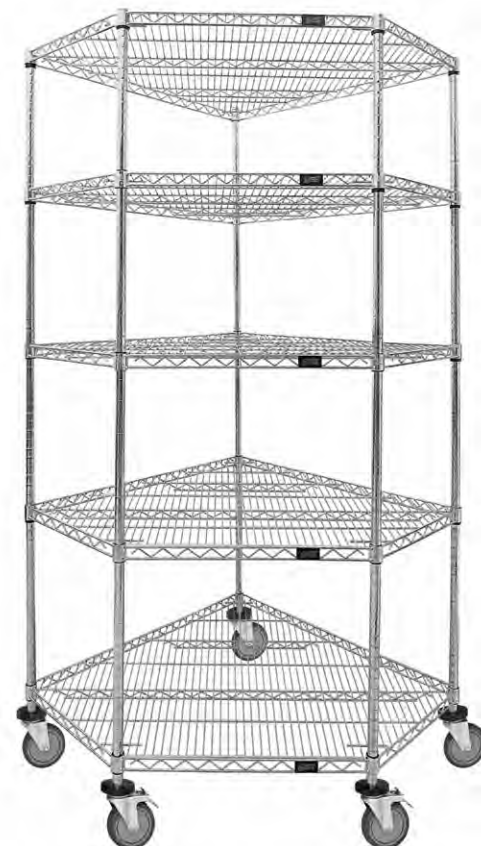

5 SHELF MOBILE UNIT

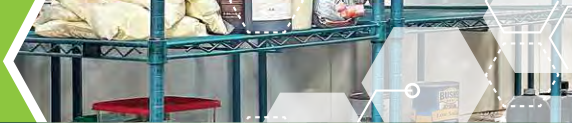

3 FINISHES AVAILABLE

Cantilever Single Shelf



Cantilever shelves have a drop mat design that provides a ledge around the shelf. Space-efficient and easy to install. Up to 150 lbs load capacity. Unit will require taller rear posts to accommodate these shelves. **Finishes:** Proform Green, Gray and Black Epoxy



MODEL NO.	DIMENSIONS W" x L"	SHIP WGT
Proform Green Epoxy Cantilever Shelves		
1224RCSP	12" x 24"	5 lbs
1230RCSP	12" x 30"	6 lbs
1236RCSP	12" x 36"	7 lbs
1242RCSP	12" x 42"	8 lbs
1248RCSP	12" x 48"	9 lbs
1260RCSP	12" x 60"	11 lbs
Gray Epoxy Cantilever Shelves		
1224RCSGY	12" x 24"	5 lbs
1230RCSGY	12" x 30"	6 lbs
1236RCSGY	12" x 36"	7 lbs
1242RCSGY	12" x 42"	8 lbs
1248RCSGY	12" x 48"	9 lbs
1260RCSGY	12" x 60"	11 lbs
Black Epoxy Cantilever Shelves		
1224RCSBK	12" x 24"	5 lbs
1230RCSBK	12" x 30"	6 lbs
1236RCSBK	12" x 36"	7 lbs
1242RCSBK	12" x 42"	8 lbs
1248RCSBK	12" x 48"	9 lbs
1260RCSBK	12" x 60"	11 lbs



Up to 150 lb.
LOAD CAPACITY PER SHELF

ATTACHES TO UNIT'S BACK POSTS

NEED EXTRA SPACE?

Dunnage Shelves



Dunnage shelves are constructed of 1" square tubular steel with removable wire decking. Utilized in extreme load applications. 1,300-1,600 lb. load capacity depending of shelf length. **Finishes:** Blue Endurance or Gray Epoxy - Excellent for high humidity or corrosive applications and is fortified with an antimicrobial agent.

BLUE ENDURANCE MODEL NO.	GRAY MODEL NO.	DIMENSIONS W" x L"	SHIP WGT
-	1824DSGY	18" x 24"	14 lbs
-	1830DSGY	18" x 30"	18 lbs
1836DS	1836DSGY	18" x 36"	21 lbs
-	1842DSGY	18" x 42"	25 lbs
1848DS	1848DSGY	18" x 48"	28 lbs
1860DS	1860DSGY	18" x 60"	34 lbs
-	2424DSGY	24" x 24"	16 lbs
-	2430DSGY	24" x 30"	20 lbs
2436DS	2436DSGY	24" x 36"	24 lbs
-	2442DSGY	24" x 42"	28 lbs
-	2448DSGY	24" x 48"	30 lbs
2460DS	2460DSGY	24" x 60"	37 lbs

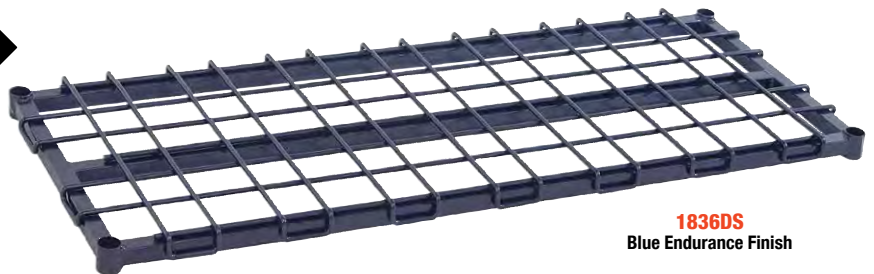

1836DS
Blue Endurance Finish

HEAVY-DUTY

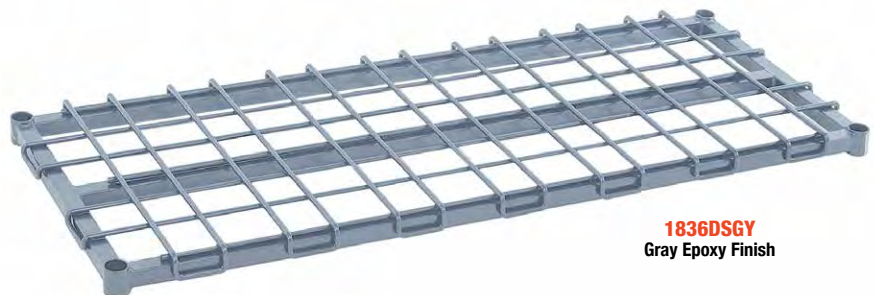

1836DSGY
Gray Epoxy Finish

Up to 1,300-1,600 lb.
LOAD CAPACITY PER SHELF

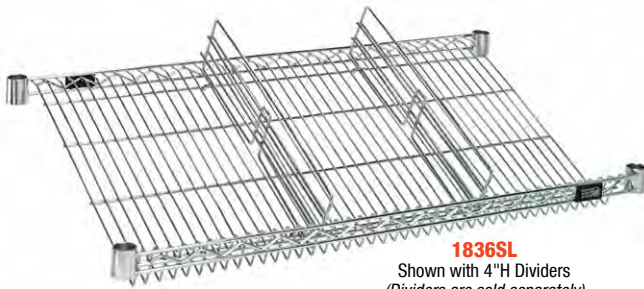

1836SL
Shown with 4" H Dividers
(Dividers are sold separately)

Slanted Shelves



Designed with a 25° slant to add structure to various applications and retain products. Perfect angle for gravity flow as well as bin storage. **Finish:** Chrome

CHROME MODEL NO.	DIMENSIONS W" x L"	SHIP WGT	DIVIDER MODEL NO.
1836SL	18" x 36"	7 lbs	DIV18SL
1848SL	18" x 48"	8 lbs	DIV18SL
2436SL	24" x 36"	8 lbs	DIV24SL
2448SL	24" x 48"	9 lbs	DIV24SL

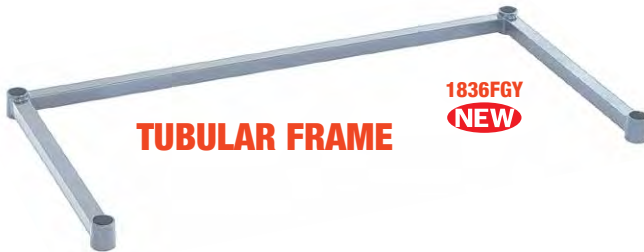

TUBULAR FRAME

1836FGY
NEW

Tubular 3 Sided Frames



Constructed of 1" square tubing, frame is designed for added structure to the perimeter of a dunnage or shelving unit. **Finish:** Gray Epoxy



GRAY MODEL NO.	DIMENSIONS W" x L"	SHIP WGT
1824FGY NEW	18" x 24"	4 lbs
1830FGY NEW	18" x 30"	4 lbs
1836FGY	18" x 36"	5 lbs
1842FGY NEW	18" x 42"	5 lbs
1848FGY	18" x 48"	6 lbs
1860FGY	18" x 60"	7 lbs
2424FGY NEW	24" x 24"	5 lbs
2430FGY NEW	24" x 30"	6 lbs
2436FGY	24" x 36"	6 lbs
2442FGY NEW	24" x 42"	7 lbs
2448FGY	24" x 48"	7 lbs
2460FGY	24" x 60"	10 lbs

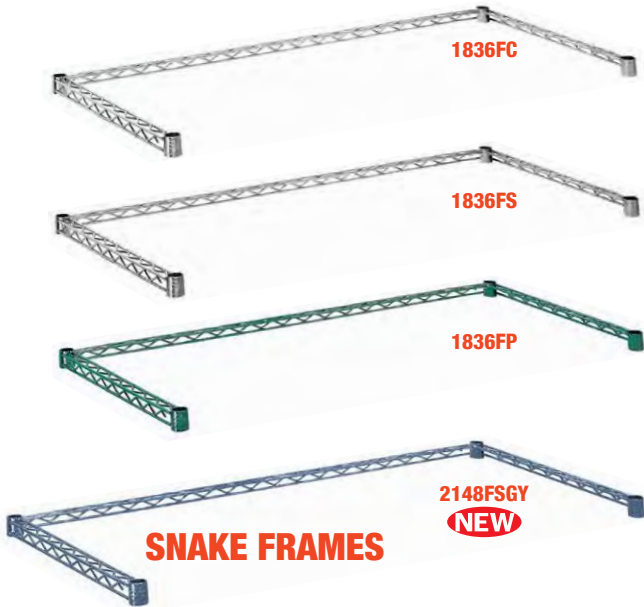

SNAKE FRAMES

1836FC

1836FS

1836FP

2148FSGY
NEW

Wire 3 Sided Snake Frames



Designed to add structure to various applications and retain products. **Finishes:** Chrome, 304 Stainless Steel, Proform Green Epoxy and Gray Epoxy



CHROME MODEL NO.	STAINLESS MODEL NO.	PROFORM MODEL NO.	GRAY MODEL NO.	DIMENSIONS W" x L"	SHIP WGT
1836FC	1836FS	1836FP	-	18" x 36"	6 lbs
1848FC	1848FS	1848FP	-	18" x 48"	7 lbs
1860FC	1860FS	1860FP	-	18" x 60"	8 lbs
-	-	-	2148FSGY NEW	21" x 48"	8 lbs
-	-	-	2160FSGY NEW	21" x 60"	9 lbs
2436FC	2436FS	2436FP	-	24" x 36"	8 lbs
2448FC	2448FS	2448FP	-	24" x 48"	9 lbs
2460FC	2460FS	2460FP	-	24" x 60"	10 lbs

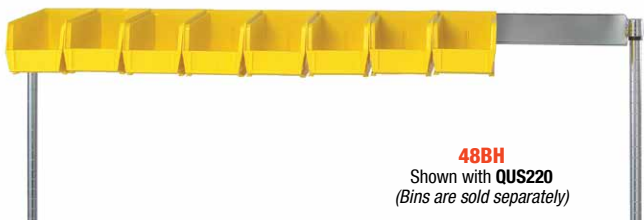

48BH
Shown with QUS220
(Bins are sold separately)

Bin Rail Holders



Creates a more functional work area with the bin rail which allows you to adapt bins to your shelving unit. Bin rail holder adjusts on 1" increments.

Finish: Chrome

MODEL NO.	DESCRIPTION	SHIP WGT
24BH NEW	One 24" Bin Holder	3 lbs
30BH NEW	One 30" Bin Holder	4 lbs
36BH	One 36" Bin Holder	5 lbs
48BH	One 48" Bin Holder	7 lbs
60BH	One 60" Bin Holder	9 lbs

MODEL NO.	QUS 210	QUS 220	QUS 221	QUS 224	QUS 230
Quantity of Ultra Bins to Fit Bin Rail Holders					
24BH	5	5	5	3	3
30BH	6	6	6	4	4
36BH	8	8	5	8	6
48BH	11	11	7	11	8
60BH	14	14	9	14	10

See pg. 93 for bin dimensions



STORAGE

HIGH DENSITY STORAGE - OVERHEAD TRACK SYSTEM

UNITS SLIDE BACK AND FORTH WITH EASE



TK-CBW
Track Roller
Included with Mobile kit
(4 per kit)

Sliding Overhead Track System



Up to **1,200 lb.**
LOAD CAPACITY PER UNIT

PERFORMANCE FEATURES AND BENEFITS:

- NSF approved
- Uses industrial bearings
- Corrosion free construction
- Easy to roll construction
- Fast installation
- Utilizes the structure of existing shelving
- Up to 1,200 lb. load capacity per unit
- Can increase storage areas up to 150%

Quantum's Overhead Track wire shelving system provides maximum storage using a minimum of space. All kits include all necessary sections of track for assembling lengths that range from 8' to 24' (**note: shelves and posts sold separately**). Assembly is quick and easy and the whole system requires only single-aisle access. Casters are 5" x 1-1/4" rigid thermoplastic resin. Overhead Track design provides a clear walkway and clear aisles underneath eliminating any tripping hazard. Overhead Track extrusion manufactured of heavy-duty aluminum ensuring years of heavy-duty and reliable service.

MODEL NO.	DESCRIPTION	SHIP WGT
Overhead Track		
TK-2	One Track - 2 Feet	7 lbs
TK-26	One Track - 2-1/2 Feet	9 lbs
TK-5	One Track - 5 Feet	17 lbs
TK-6	One Track - 6 Feet	21 lbs
TK-7	One Track - 7 Feet	24 lbs
TK-EP	Track End Plates with Hardware (Set of 4)	1 lb
TK-CA	Track Connector with Hardware (Set of 4)	6 lbs
End Unit Single Sided Track Bracket Pair		
TK-STB18	18" Single Overhead Track Bracket Pair	4 lbs
TK-STB21	21" Single Overhead Track Bracket Pair	5 lbs
TK-STB24	24" Single Overhead Track Bracket Pair	6 lbs
Intermediate Unit Double Sided Track Bracket Pair		
TK-DTB18	18" Double Overhead Track Bracket Pair	4 lbs
TK-DTB21	21" Double Overhead Track Bracket Pair	5 lbs
TK-DTB24	24" Double Overhead Track Bracket Pair	6 lbs
Mobile Unit Track Rollers		
TK-CBW	Set of 4 Track Rollers	2 lbs



TK-EP
Track End Plate
(4 per kit)



TRACK WITHOUT END PLATE



TRACK WITH END PLATE

INCREASE STORAGE AREAS UP TO 150%





STATIONARY END KIT
(Shelves sold separately)



INTERMEDIATE KIT
(Shelves sold separately)



MOBILE KIT
(Shelves sold separately)

STEP BY STEP ORDERING INSTRUCTIONS:

- Step 1.** Select desired length of track.
- Step 2.** Select corresponding stationary end kit and intermediate kits from charts. Size should match the depth of shelving unit being utilized.
- Step 3.** Using the chart on the bottom of this page, determine how many Mobile Kits will fit on your track.
- Step 4.** Wire shelves are available on pg. 24.

ADD SUFFIX TO END OF EACH CHROME MODEL NO. WHEN SELECTING EPOXY FINISH

◆ GREEN P ◆ GRAY GY ◆ BLACK BK

Ex. TTK-M18BK

Stationary End Kits

- Unit consists of:
 8 - 86" Posts*
 8 - Foot plates
 4 - Single sided overhead track support brackets

SINGLE SUPPORT BRACKET



MODEL NO.	DESCRIPTION	SHIP WGT
TTK-E18	18" Stationary End Kits	64 lbs
TTK-E21	21" Stationary End Kits	72 lbs
TTK-E24	24" Stationary End Kits	80 lbs

*86" posts are available with pre-inserted leveler and bolt by adding an X to the Model No. TTK-E18X

Intermediate Kits

- Unit consists of:
 4 - 86" Posts*
 4 - Foot plates
 2 - Double sided overhead track support brackets

DOUBLE SUPPORT BRACKET



MODEL NO.	DESCRIPTION	SHIP WGT
TTK-C18	18" Intermediate Kits	32 lbs
TTK-C21	21" Intermediate Kits	36 lbs
TTK-C24	24" Intermediate Kits	40 lbs

*86" posts are available with pre-inserted leveler and bolt by adding an X to the Model No. TTK-C18X

Mobile Kits

- Unit consists of:
 4 - 74" Posts
 4 - Track rollers
 2 - Tie bars

- 4 - Rigid casters
- 4 - Donut bumpers

MOBILE KITS



MODEL NO.	DESCRIPTION	SHIP WGT
TTK-M18	18" Mobile Kit	34 lbs
TTK-M21	21" Mobile Kit	36 lbs
TTK-M24	24" Mobile Kit	38 lbs

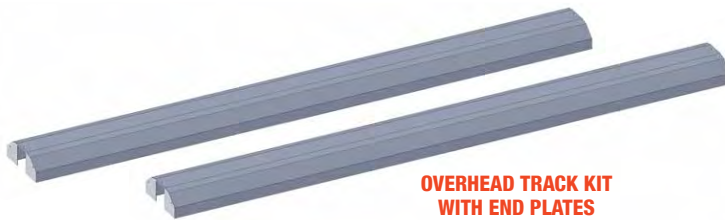

OVERHEAD TRACK KIT WITH END PLATES

Overhead Track Kits

Each kit includes two track of the same length and end plates. Available in heavy-duty aluminum.

MODEL NO.	TRACK LENGTH' (FT)	TRACK LENGTH" (IN)	SHIP WGT
Overhead Track Kit			
TTK-8	8'	96"	53 lbs
TTK-9	9'	108"	60 lbs
TTK-10	10'	120"	67 lbs
TTK-11	11'	132"	73 lbs
TTK-12	12'	144"	80 lbs
TTK-13	13'	156"	87 lbs
TTK-14	14'	168"	93 lbs
TTK-15	15'	180"	100 lbs
TTK-16	16'	192"	107 lbs
TTK-17	17'	204"	113 lbs
TTK-18	18'	216"	120 lbs
TTK-19	19'	228"	127 lbs
TTK-20	20'	240"	133 lbs
TTK-21	21'	252"	140 lbs

QUANTITY OF SHELVING UNITS BY WIDTH TO FIT ON LENGTH OF TRACK*

	8'	9'	10'	11'	12'	13'	14'	15'	16'	17'	18'	19'	20'	21'
18"	3	3	4	4	5	6	6	7	7	8	9	9	10	10
21"	2	3	3	4	4	5	5	6	6	7	7	8	8	9
24"	2	2	3	3	4	4	5	5	6	6	7	7	8	8

*Using a minimum 36" aisle space



STORAGE

HIGH DENSITY STORAGE - FLOOR TRACK SYSTEM

High Density Sliding Floor Track System



High Density Sliding Track System offers a unique way to maximize and efficiently move wire shelving systems. The patented design allows for quick and easy installation. Bearings in the skate are located under each post for a load capacity of up to 1,500 lb. per shelving unit. The v-groove floor track allows the shelving unit to slide back and forth with ease. Layout assistance is available.

PERFORMANCE FEATURES AND BENEFITS:

- Low shipping cost
- NSF approved
- Uses industrial bearings
- Corrosion free construction
- Easy to roll construction
- Fast installation
- Utilizes the structure of existing shelving
- Complies with ADA regulations
- Up to 1,500 lb. load capacity per unit
- Can increase storage areas up to 150%



SYSTEMS SLIDE BACK AND FORTH WITH EASE

QUESTP End Stop Kit

Includes 2 ends and 1 drill bit. Serves the dual purpose of stopping a skate and is the anchor for the track. Manufactured from shock absorbing polymer. One kit is required per track.

QVTRK V-Groove Track

Aluminum design with 304 stainless steel inserts with a gradual taper, non-tripping hazard, 7/16" max height. (Sold by the inch)

HD18 - HD36 One Skate

Aluminum with engineered plastic wheel housing and industrial 2,000 lb. capacity bearings on each end.

DR Drift Resistor

Reduces speed and impact.

WK Wing Kit

Includes four 1/4" thick aluminum plates and hardware and allows for the joining of 2 units side by side, sharing one track.



SK Shim Kit

48" L thick aluminum strips which can be placed underneath track to help create a level surface. (6 per kit)

MODEL NO.	DESCRIPTION	SHIP WGT
Sliding Track Skates		
Also Available with Drift Resistor Add Suffix "DR"		
HD18	One 18" Skate	4 lbs
HD21	One 21" Skate	5 lbs
HD24	One 24" Skate	6 lbs
HD30	One 30" Skate	7 lbs
HD36	One 36" Skate	8 lbs
Additional Components		
QUESTP	End Stop Kit	1 lb
QBRK	Foot Activated Brake Kit	1 lb
QVTRK	V-Track (Sold per inch)	1 lb
WK	Wing Kit	2 lbs
SK*	Shim Kit	3 lbs

*Shim kit comes with (6) 2" x 48" x 1/16" thick aluminum strips which can be placed underneath track to help create a level surface

STEP BY STEP ORDERING INSTRUCTIONS:

(Note: Shelves and posts to be purchased separately on pgs. 24-25)

- Step 1.** Select desired length (in inches) of track. Use QVTRK to order track. (Note: single units require two tracks and double units will require three tracks)
- Step 2.** Select corresponding skate size from the chart, which will be the same as the depth of shelving unit to be utilized. Two skates required per single unit and three skates required per double unit. (Note: post height should not exceed a 4 to 1 ratio of skate size)
- Step 3.** Purchase one End Stop Kit QUESTP per track length. For each double unit being used, a Wing Kit WK is required.



SINGLE UNIT TRACK SYSTEM

(Top View)

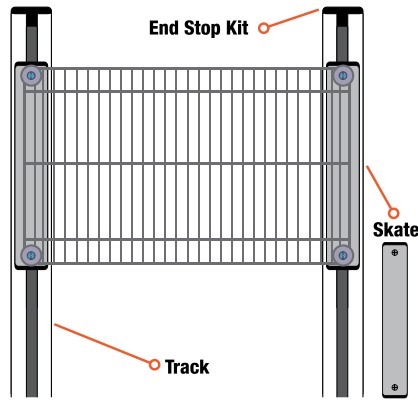

DOUBLE UNIT TRACK SYSTEM

(Top View)

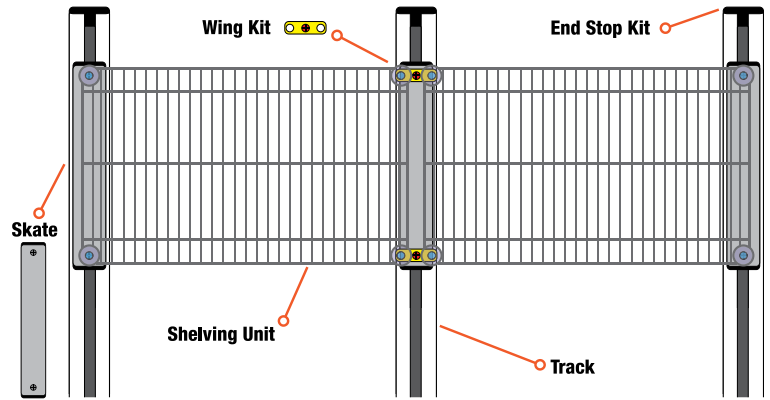

Single Unit Floor Track Assemblies



Assembly kit consists of a pair of aluminum tracks with end stop kits. Hardware and assembly instructions included. **(Note: custom lengths may be purchased, see pg. 56)**

MODEL NO.	TRACK L' (FT)	TRACK L' (IN)	SHIP WGT
Single Unit Floor Track Assembly Kit Includes 2 Tracks of Specified Length with End Stop Kits			
QVTRK-2-72EST	6'	72"	14 lbs
QVTRK-2-84EST	7'	84"	16 lbs
QVTRK-2-96EST	8'	96"	18 lbs
QVTRK-2-108EST	9'	108"	20 lbs
QVTRK-2-120EST	10'	120"	22 lbs
QVTRK-2-132EST	11'	132"	24 lbs
QVTRK-2-144EST	12'	144"	26 lbs
QVTRK-2-156EST	13'	156"	28 lbs
QVTRK-2-168EST	14'	168"	30 lbs
QVTRK-2-180EST	15'	180"	32 lbs
QVTRK-2-192EST	16'	192"	34 lbs
QVTRK-2-204EST	17'	204"	36 lbs
QVTRK-2-216EST	18'	216"	38 lbs
QVTRK-2-228EST	19'	228"	40 lbs
QVTRK-2-240EST	20'	240"	42 lbs

Single Unit Skate Assembly Kits



Each kit includes two skates and all appropriate hardware. One kit is required for each single mobile unit. *(Shelves and posts sold separately on pgs. 24-25)*

MODEL NO.	DESCRIPTION	SHIP WGT
Single Unit Skate Assembly Kits Also Available with Drift Resistor Add Suffix "DR"		
HD18-2	Two 18" Skates	8 lbs
HD21-2	Two 21" Skates	10 lbs
HD24-2	Two 24" Skates	12 lbs
HD30-2	Two 30" Skates	14 lbs
HD36-2	Two 36" Skates	16 lbs

Up to 1,500 lb.
SLIDE LOAD CAPACITY
PER SHELVING UNIT

STEP BY STEP ORDERING INSTRUCTIONS:

- Select desired length of track and if you require:
 - Single Unit track (use charts on left)
 - Double Unit track (use charts on right)
- Select corresponding skate size from single or double unit charts below. Skate size should match the depth of shelving unit being utilized.
- Using the chart on the bottom of this page, determine how many shelving units will fit on your track.
- Pre-configured 4 and 5 shelf wire units are available on pgs. 26-29. Additional intermediate shelves are available on pg. 24.

Double Unit Floor Track Assemblies



Each assembly kit consists of three aluminum tracks with end stop kits. Hardware and assembly instructions included. **(Note: custom lengths may be purchased, see pg. 56)**

MODEL NO.	TRACK L' (FT)	TRACK L' (IN)	SHIP WGT
Double Unit Floor Track Assembly Kit Includes 3 Tracks of Specified Length with End Stop Kits			
QVTRK-3-72EST	6'	72"	21 lbs
QVTRK-3-84EST	7'	84"	24 lbs
QVTRK-3-96EST	8'	96"	27 lbs
QVTRK-3-108EST	9'	108"	30 lbs
QVTRK-3-120EST	10'	120"	33 lbs
QVTRK-3-132EST	11'	132"	36 lbs
QVTRK-3-144EST	12'	144"	39 lbs
QVTRK-3-156EST	13'	156"	42 lbs
QVTRK-3-168EST	14'	168"	45 lbs
QVTRK-3-180EST	15'	180"	48 lbs
QVTRK-3-192EST	16'	192"	51 lbs
QVTRK-3-204EST	17'	204"	54 lbs
QVTRK-3-216EST	18'	216"	57 lbs
QVTRK-3-228EST	19'	228"	60 lbs
QVTRK-3-240EST	20'	240"	63 lbs

Double Unit Skate Assembly Kits



Each kit includes three skates and all appropriate hardware. One kit is required for each double mobile unit. *(Shelves and posts sold separately on pgs. 24-25)*

MODEL NO.	DESCRIPTION	SHIP WGT
Double Unit Skate Assembly Kits Also Available with Drift Resistor Add Suffix "DR"		
HD18-3	Three 18" Skates + Wing Kit	15 lbs
HD21-3	Three 21" Skates + Wing Kit	18 lbs
HD24-3	Three 24" Skates + Wing Kit	21 lbs
HD30-3	Three 30" Skates + Wing Kit	24 lbs
HD36-3	Three 36" Skates + Wing Kit	27 lbs

QUANTITY OF SHELVING UNITS BY WIDTH TO FIT ON LENGTH OF TRACK*

	6'	7'	8'	9'	10'	11'	12'	13'	14'	15'	16'	17'	18'	19'	20'
18"	2	2	3	4	4	5	6	6	7	8	8	9	10	10	11
21"	1	2	2	3	4	4	5	5	6	6	7	8	8	9	9
24"	1	2	2	3	3	4	4	5	5	6	6	7	7	8	8
30"	1	1	2	2	2	3	3	4	4	4	5	5	6	6	6
36"	1	1	1	2	2	2	3	3	3	4	4	4	5	5	5

*Using a minimum 36" aisle space **Note:** Post height should not exceed the skate length by a 4 to 1 ration (example 18" skate should not exceed a 74" post)



MAXIMUM EFFICIENCY

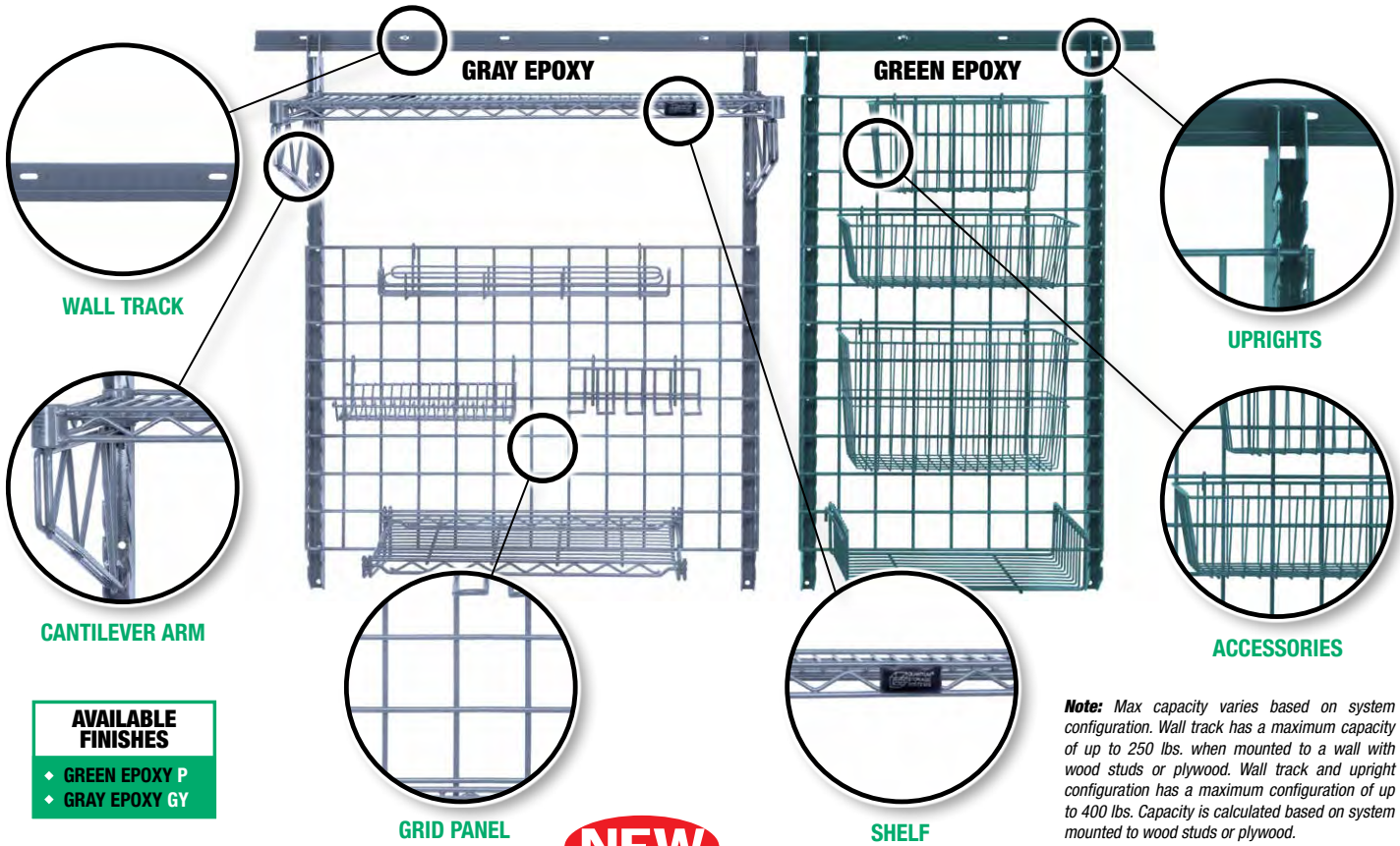

Store Grid Mount System



NEW
GRAY EPOXY FINISH

A versatile storage, utility, and display system suited to maximize efficiencies of underutilized spaces and empty walls. Store Grid is an easy to use system that integrates wall tracks, grids, wall shelving, and accessories in custom configurations and lengths. The use of the system around and above sinks, prep-stations, work tables, staging areas and equipment will keep these areas cleaner and more organized. Store Grid enables the flexibility to add wall shelving and wall mounted task stations to any space for ease of accessibility and functionality. The durability of the 15 year warranty antimicrobial epoxy and robust design of the system protects against product degradation and ensures easy installation and maintenance. **Finishes:** Proform Green and Gray Epoxy

- Antimicrobial additive protects the epoxy from bacteria, mold, and mildew that causes stains, odors, and product degradation.
- Keep small wares, utilities, inventory, tools, containers, utensils, and supplies off of the work surface and organized for fast, easy access. The work area remains clean and free from clutter to increase efficiencies.
- Grids attach to the uprights and enable the customizable configurations of accessories - bulk storage shelves, small supply shelves, baskets, hooks, drying rack accessories, utensil holders, bins, small utility racks, and a variety of holders.
- Easy installation and assembly. Mount the wall track and configure a customized work space using uprights, grids, shelves, and accessories.

IDEAL FOR MAXIMIZING EFFICIENCY IN ANY PREPARATION, STORAGE OR WORK SPACE



- ### TO ORDER:
1. Select size of Store Grid wall tracks depending on the space you have
 2. Select size and quantity of uprights
 3. Select number of shelves and cantilevers (two per shelf)
 4. Select grid and accessories

Product Notes

When configuring task stations with uprights, select shelves and grids of the same length. Longer grids may be used, although must not overhang the upright by more than 6" on either side. Grids may be mounted behind shelves. However, shelf support and grid cannot use the same slots on the upright. Maximum usable wall track mounting space is the track length minus 2" (stop fasteners are installed at each end of a run of wall track and occupy around 1" of track space on each end)

Shelves, shelf brackets, grids, and accessories may be removed for in-depth cleaning of walls. Wall tracks and uprights can be wiped clean. **Note:** Do not use abrasive chemicals or materials since these may damage the protective coating. Clean with mild detergents and damp cloths.

Recommendations

Wash Stations: use shelves, baskets, drying racks and hooks for proper air drying of items used in food preparation.

Prep Stations: use shelves, baskets, bins, hooks, spice rack, and glove box holder for a neater work space.



FLEXIBLE - WALL TRACKS AND UPRIGHTS ARE DESIGNED TO INTERFACE WITH WOOD STUDS, PLYWOOD, CONCRETE, AND OTHER SUITABLE WALL SURFACES

Wall Tracks

12 gauge cold rolled steel; obround mounting holes located at 8" increments; first and last holes are located 4" from the ends of the track; obround hole dimensions (1/8" x 3/4"). Wall tracks include stop fasteners for the ends of the tracks and joiner plates for connecting adjacent tracks. Hardware not included.



SG-WT56P
Wall Track
56"

Uprights

12 gauge cold rolled steel; slotted every 1-1/2"; 1-1/8" diameter mounting holes are spaced every 6" along the upright, sold by each upright. These slots attach to grids and shelf supports in a clip-in function.



Upright

Wire Grids

1/4" diameter cold rolled steel wire create with 3" x 3" openings that are easily attached to the uprights.

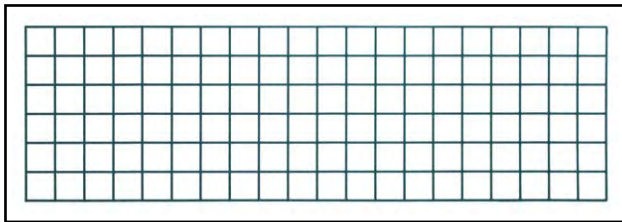

SG-1860P
Wire Grid
18" x 60"

Cantilevers

Mounts directly onto uprights. Available in single and double configurations, and in four different depths. Two single cantilevers are required for each end of a unit. Sold by the each.



SG-CS14P
Single Support

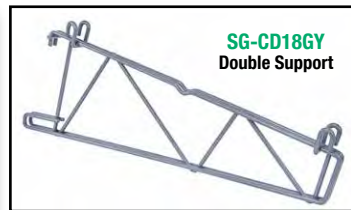

SG-CD186Y
Double Support

Brackets

For use in light and standard-duty applications without uprights. One kit required per grid.

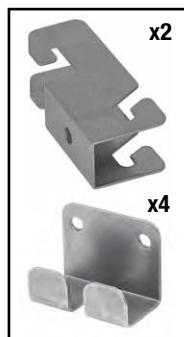

SG-WTBS
Mounting Bracket
Kit For Wall Track
(Pack of 6)

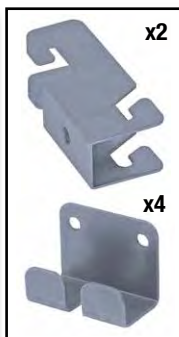

SG-WTBGY
Mounting Bracket
Kit For Wall Track
(Pack of 6)



SG-DWB
Mounting
Bracket
Kit For Wall
(Pack of 6)



SG-PWM
Plastic Grid
Mounting
Bracket Kit
For Wall
(Pack of 6)

Metal finishes: ▲ P ▲ GY

PROFORM MODEL NO.	GRAY MODEL NO.	DESCRIPTION	CTN QTY	CTN WGT
Store Grid Wall Mount Tracks				
SG-WT40P	SG-WT40GY	40" Wall Track	1	5 lbs
SG-WT56P	SG-WT56GY	56" Wall Track	1	6 lbs
SG-WT72P	SG-WT72GY	72" Wall Track	1	7 lbs

Metal finishes: ▲ P ▲ GY

PROFORM MODEL NO.	GRAY MODEL NO.	DESCRIPTION	CTN QTY	CTN WGT
Store Grid Wall Mount Uprights				
SG-U16P	SG-U16GY	16" Upright	1	2 lbs
SG-U31P	SG-U31GY	31" Upright	1	4 lbs
SG-U44P	SG-U44GY	44-1/2" Upright	1	5 lbs

Metal finishes: ▲ P ▲ GY

PROFORM MODEL NO.	GRAY MODEL NO.	DESCRIPTION	CTN QTY	CTN WGT
Store Grid Wall Mount Grids				
SG-1830P	SG-1830GY	18" x 30" Grid	1	8 lbs
SG-1836P	SG-1836GY	18" x 36" Grid	1	9 lbs
SG-1848P	SG-1848GY	18" x 48" Grid	1	12 lbs
SG-1860P	SG-1860GY	18" x 60" Grid	1	14 lbs
SG-2430P*	SG-2430GY	24" x 30" Grid	1	10 lbs
SG-2436P	SG-2436GY	24" x 36" Grid	1	12 lbs
SG-2448P	SG-2448GY	24" x 48" Grid	1	15 lbs
SG-3036P	SG-3036GY	30" x 36" Grid	1	13 lbs
SG-3048P	SG-3048GY	30" x 48" Grid	1	17 lbs
SG-3354P	SG-3354GY	33" x 54" Grid	1	21 lbs

*COMING SOON!

Metal finishes: ▲ P ▲ GY

PROFORM MODEL NO.	GRAY MODEL NO.	DESCRIPTION	CTN QTY	CTN WGT
Store Grid Wall Mount Tracks				
SG-CS14P	SG-CS14GY	14" Shelf Single Cantilever	1	3 lbs
SG-CS18P	SG-CS18GY	18" Shelf Single Cantilever	1	3 lbs
SG-CS21P	SG-CS21GY	21" Shelf Single Cantilever	1	4 lbs
SG-CS24P	SG-CS24GY	24" Shelf Single Cantilever	1	4 lbs
SG-CD14P	SG-CD14GY	14" Shelf Double Cantilever	1	3 lbs
SG-CD18P	SG-CD18GY	18" Shelf Double Cantilever	1	3 lbs
SG-CD21P	SG-CD21GY	21" Shelf Double Cantilever	1	4 lbs
SG-CD24P	SG-CD24GY	24" Shelf Double Cantilever	1	4 lbs

Shelf Cantilevers provide support for Quantum 14", 18", 21" and 24" epoxy shelves. Double Cantilevers are used for a side-by-side configuration.

Finishes: ▲ S ▲ GY ● BK

MODEL NO.	DESCRIPTION	CTN QTY	CTN WGT
Store Grid Wall Mount Bracket			
SG-DWB	Stainless Steel Mounting Bracket Kit For Wall (Pack of 6)	1	2 lbs
SG-PWM	Plastic Grid Mounting Bracket Kit For Wall (Pack of 6)	1	2 lbs
SG-WTBS	Stainless Steel Mounting Bracket Kit For Wall Track (Pack of 6)	1	2 lbs
SG-WTBGY	Epoxy Gray Mounting Bracket Kit For Wall Track (Pack of 6)	1	2 lbs



Store Grid Kits

SGK-2448-1P

Light-Duty Task Station

- Wall storage space ideal for Prep Stations
- 24" x 48" grid space
- Easy to rearrange accessories
- Antimicrobial additive protects the epoxy coating from bacteria, mold, and mildew.

Metal finishes: GY

Ship Weight - 47 lbs

Unit consists of:

- 1 - Wire Grid - **SG-2448P**
- 1 - Basket 17-3/8" x 7-1/2" x 5" - **SG-B1775P**
- 1 - Basket 17-3/8" x 7-1/2" x 10" - **SG-B17710P**
- 6 - Hook - **SG-HOOK6P**
- 6 - Hook - **SG-HOOKSM**
- 1 - Mounting Bracket - **SG-DWB**

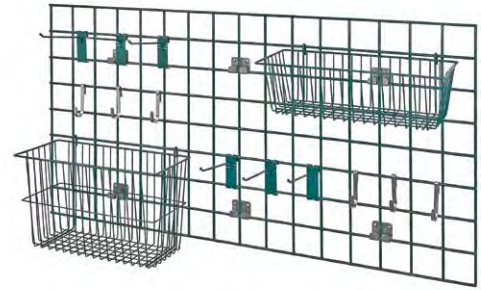

SGK-3036-1GY

Light-Duty Task Station

- Wall storage space ideal for Wash Stations
- 30" x 36" grid space
- Easy to rearrange accessories
- Antimicrobial additive protects the epoxy coating from bacteria, mold, and mildew.

Metal finishes: GY

Ship Weight - 44 lbs

Unit consists of:

- 1 - Wire Grid - **SG-3036GY**
- 1 - Basket 17-3/8" x 7-1/2" x 5" - **SG-B1775GY**
- 1 - Basket 17-3/8" x 7-1/2" x 10" - **SG-B17710GY**
- 1 - Shelf 9" x 18" - **SG-S918GY**
- 1 - Drying Rack - **SG-LH1384GY**
- 1 - Utensil Holder - **SG-UH4GY**
- 1 - Hook - **SG-HOOK6GY**
- 2 - Hook - **SG-HOOKSM**
- 1 - Hook - **SG-HOOKDB**
- 1 - Mounting Bracket - **SG-DWB**

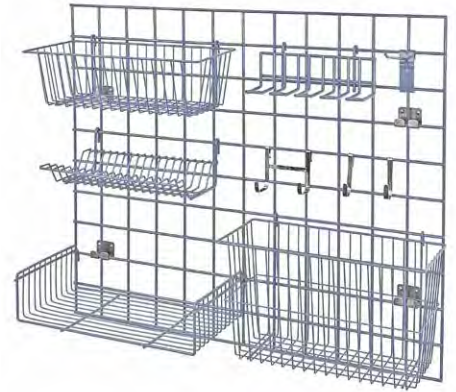

SGK-401836-1P

Medium-Duty Task Station

- Wall storage space with a 1836P wire shelf
- 18" x 36" grid space
- 40" track
- Antimicrobial additive protects the epoxy coating from bacteria, mold, and mildew.

Metal finishes: GY

Ship Weight - 38 lbs

Unit consists of:

- 1 - Wall Track - **SG-WT40P**
- 2 - Upright - **SG-U31P**
- 2 - Single Cantilever Arm - **SG-CS18P**
- 1 - Shelf 18" x 36" - **1836P**
- 1 - Wire Grid - **SG-1836P**



SGK-401836-2GY

Medium-Duty Task Station

- Wall storage space with a 1836P wire shelf, ideal for Wash Stations
- 18" x 36" grid space
- 40" track
- Antimicrobial additive protects the epoxy coating from bacteria, mold, and mildew.

Metal finishes: GY

Ship Weight - 57 lbs

Unit consists of:

- 1 - Wall Track - **SG-WT40GY**
- 2 - Upright - **SG-U31GY**
- 2 - Single Cantilever Arm - **SG-CS18GY**
- 1 - Shelf 18" x 36" - **1836GY**
- 1 - Wire Grid - **SG-1836GY**
- 1 - Basket 17-3/8" x 7-1/2" x 5" - **SG-B1775GY**
- 1 - Drying Rack - **SG-LH1384GY**
- 1 - Flatware Cylinder - **SG-CH**
- 1 - Cylinder Holder - **SG-CMBGY**
- 2 - Hook - **SG-HOOK6GY**
- 6 - Hook - **SG-HOOKSM**





Store Grid Kits

SGK-401836-3P

Medium-Duty Task Station

- Wall storage space with an 18" x 36" wire and solid shelf
- 18" x 36" grid space
- 40" track
- Antimicrobial additive protects the epoxy coating from bacteria, mold, and mildew.

Metal finishes: P GY

Ship Weight - 66 lbs

Unit consists of:

- 1 - Wall Track - **SG-WT40P**
- 2 - Upright - **SG-U44P**
- 4 - Single Cantilever Arm - **SG-CS18P**
- 1 - Shelf 18" x 36" - **1836P**
- 1 - Shelf 18" x 36" - **1836SG**
- 1 - Wire Grid - **SG-1836P**
- 1 - Shelf 16" x 16" - **SG-S1616P**
- 2 - Shelf 9" x 18" - **SG-S918P**



SGK-401836-4GY

Medium-Duty Task Station

- Wall storage space with a 1836GY wire shelf, ideal for Prep Stations
- 18" x 36" grid space
- 40" track
- Antimicrobial additive protects the epoxy coating from bacteria, mold, and mildew.

Bin available in: BL GN IV RD YL BK CL

Metal finishes: P GY

Ship Weight - 65 lbs

Unit consists of:

- 1 - Wall Track - **SG-WT40GY**
- 2 - Upright - **SG-U31GY**
- 2 - Single Cantilever Arm - **SG-CS18GY**
- 1 - Shelf 18" x 36" - **1836GY**
- 1 - Wire Grid - **SG-1836GY**
- 1 - Basket 17-3/8" x 7-1/2" x 5" - **SG-B1775GY**
- 2 - Hook - **SG-HOOK6GY**
- 6 - Hook - **SG-HOOKSM**
- 1 - Shelf 9" x 18" - **SG-S918GY**
- 1 - Bin 10-7/8" x 5-1/2" x 5" - **QUS230**
- 1 - Bin Holder - **SG-SBH**

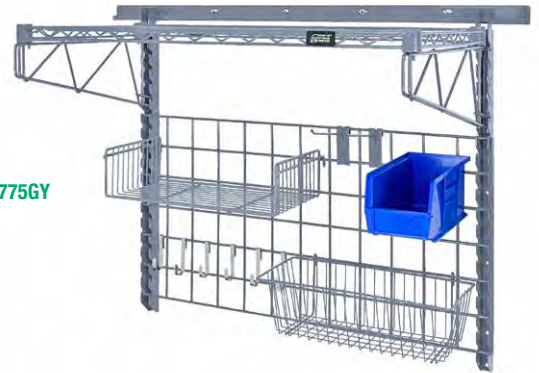

SGK-402436-1P

Standard-Duty Task Station

- Wall storage space with an 18" x 36" open grid polymer shelf
- 24" x 36" grid space
- 40" track
- Antimicrobial additive protects the epoxy coating from bacteria, mold, and mildew.

Metal finish: P

Ship Weight - 56 lbs

Unit consists of:

- 1 - Wall Track - **SG-WT40P**
- 2 - Single Cantilever Arm - **SG-CS18P**
- 1 - Shelf 18" x 36" - **1836WPM**
- 1 - Wire Grid - **SG-2436P**
- 2 - Basket 17-3/8" x 7-1/2" x 5" - **SG-B1775P**
- 2 - Utensil Holder - **SG-UH10P**
- 1 - Mounting Bracket - **SG-WTBP**

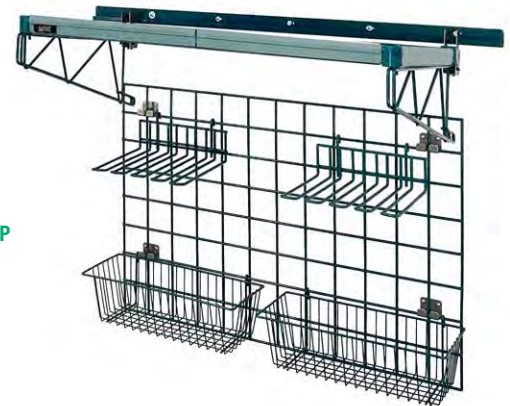

SGK-403036-1GY

Standard-Duty Task Station

- Wall storage space with an 18" x 36" grid shelf
- 30" x 36" grid space
- 40" track
- Antimicrobial additive protects the epoxy coating from bacteria, mold, and mildew.

Metal finishes: P GY

Ship Weight - 22 lbs

Unit consists of:

- 1 - Wall Track - **SG-WT40GY**
- 1 - Wire Grid - **SG-3036GY**
- 1 - Shelf 18" x 36" - **SG-LS1836GY**
- 1 - Mounting Bracket - **SG-WTBGY**

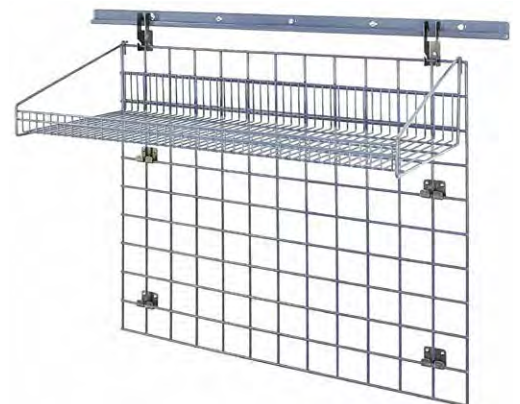



Store Grid Kits

SGK-403036-2GY

Standard-Duty Task Station

- Wall storage space with an 18" x 36" grid shelf
- 30" x 36" grid space
- 40" track
- Antimicrobial additive protects the epoxy coating from bacteria, mold, and mildew.

Bin available in: ● BL ● GN ● IV ● RD ● YL ● BK ● CL

Metal finishes: ▲ P ▲ GY

Ship Weight - 44 lbs

Unit consists of:

- 1 - Wall Track - **SG-WT40GY**
- 1 - Wire Grid - **SG-3036GY**
- 1 - Shelf 18" x 36" - **SG-LS1836GY**
- 1 - Basket 17-3/8" x 7-1/2" x 5" - **SG-B1775GY**
- 2 - Hook - **SG-HOOK6GY**
- 10 - Hook - **SG-HOOKSM**
- 1 - Shelf 9" x 18" - **SG-S918GY**
- 1 - Bin 10-7/8" x 5-1/2" x 5" - **QUS230**
- 1 - Bin Holder - **SG-SBH**
- 1 - Mounting Bracket - **SG-WTBGY**

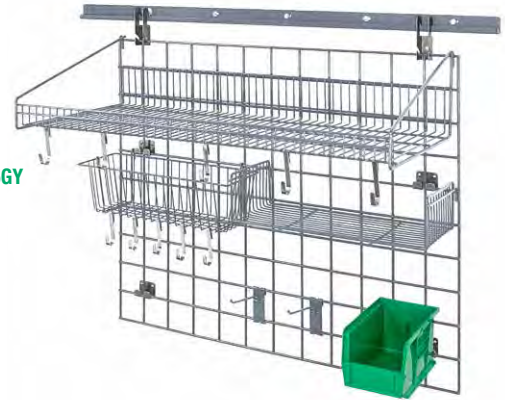

SGK-403036-3P

Medium-Duty Task Station

- Wall storage space with an 18" x 36" grid shelf, ideal for Wash Stations
- 30" x 36" grid space
- 40" track
- Antimicrobial additive protects the epoxy coating from bacteria, mold, and mildew.

Metal finishes: ▲ P ▲ GY

Ship Weight - 60 lbs

Unit consists of:

- 1 - Wall Track - **SG-WT40P**
- 2 - Upright - **SG-U31P**
- 1 - Wire Grid - **SG-3036P**
- 1 - Shelf 18" x 36" - **SG-LS1836P**
- 1 - Shelf 9" x 18" - **SG-S918P**
- 1 - Basket 13-3/8" x 5" x 7" - **SG-B1357P**
- 1 - Basket 17-3/8" x 7-1/2" x 5" - **SG-B1775P**
- 1 - Basket 17-3/8" x 7-1/2" x 10" - **SG-B17710P**
- 1 - Flatware Cylinder - **SG-CH**
- 1 - Cylinder Holder - **SG-CMBP**
- 2 - Hook - **SG-HOOK6P**



SGK-562448-1GY

Medium-Duty Task Station

- Wall storage space with 1848P wire shelves, ideal for Wash Stations
- 24" x 48" grid space
- 56" track
- Antimicrobial additive protects the epoxy coating from bacteria, mold, and mildew.

Metal finishes: ▲ P ▲ GY

Ship Weight - 92 lbs

Unit consists of:

- 1 - Wall Track - **SG-WT56GY**
- 2 - Upright - **SG-U44GY**
- 4 - Single Cantilever Arm - **SG-CS18GY**
- 2 - Shelf 18" x 48" - **1848GY**
- 1 - Wire Grid - **SG-2448GY**
- 1 - Basket 17-3/8" x 7-1/2" x 5" - **SG-B1775GY**
- 1 - Drying Rack - **SG-LH1384GY**
- 1 - Flatware Cylinder - **SG-CH**
- 1 - Cylinder Holder - **SG-CMBGY**
- 4 - Hook - **SG-HOOK6GY**
- 6 - Hook - **SG-HOOKSM**

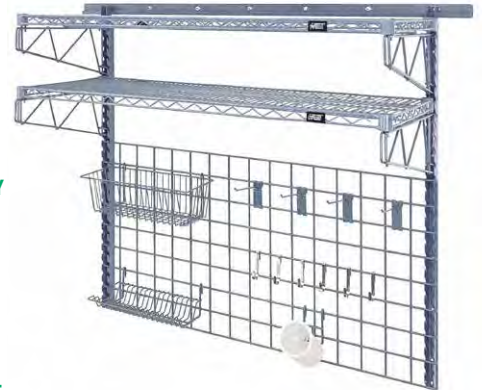

SGK-563048-1P

Medium-Duty Task Station

- Wall storage space ideal for Wash Stations
- 30" x 48" grid space
- 56" track
- Antimicrobial additive protects the epoxy coating from bacteria, mold, and mildew.

Metal finishes: ▲ P ▲ GY

Ship Weight - 59 lbs

Unit consists of:

- 1 - Wall Track - **SG-WT56P**
- 2 - Upright - **SG-U31P**
- 1 - Wire Grid - **SG-3048P**
- 1 - Drying Rack - **SG-TDR461410P**
- 2 - Drying Rack - **SG-SLH201412P**
- 2 - Bottle Holder - **SG-BR6P**
- 2 - Hook - **SG-HOOK6P**

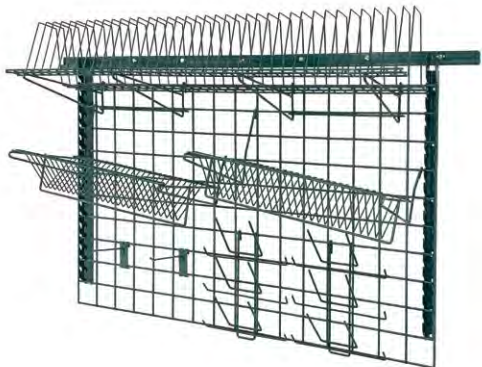



Store Grid Kits

SGK-721830-1P

Medium-Duty Task Station

- Wall storage space ideal for Wash Stations
- 36" x 60" grid space
- 72" track
- Antimicrobial additive protects the epoxy coating from bacteria, mold, and mildew.

Metal finishes:

Ship Weight - 89 lbs

Unit consists of:

- 1 - Wall Track - **SG-WT72P**
- 4 - Upright - **SG-U44P**
- 4 - Wire Grid - **SG-1830P**
- 2 - Shelf 18" x 30" - **SG-LS1830P**
- 2 - Flatware Cylinder - **SG-CH**
- 2 - Cylinder Holder - **SG-CMBP**
- 2 - Utensil Holder - **SG-UH10P**
- 2 - Utensil Holder - **SG-UH4P**
- 2 - Drying Rack - **SG-LH1384P**



SGK-723036-1GY

Medium-Duty Task Station

- Wall storage space ideal for Wash Stations
- 30" x 72" grid space
- 72" track
- Antimicrobial additive protects the epoxy coating from bacteria, mold, and mildew.

Metal finishes:

Ship Weight - 101 lbs

Unit consists of:

- 1 - Wall Track - **SG-WT72GY**
- 4 - Upright - **SG-U44GY**
- 2 - Wire Grid - **SG-3036GY**
- 2 - Shelf 18" x 36" - **SG-LS1836GY**
- 2 - Flatware Cylinder - **SG-CH**
- 2 - Cylinder Holder - **SG-CMBGY**
- 2 - Basket 17-3/8" x 7-1/2" x 10" - **SG-B17710GY**
- 2 - Drying Rack - **SG-LH1384GY**
- 4 - Hook - **SG-HOOK6GY**
- 10 - Hook - **SG-HOOKSM**

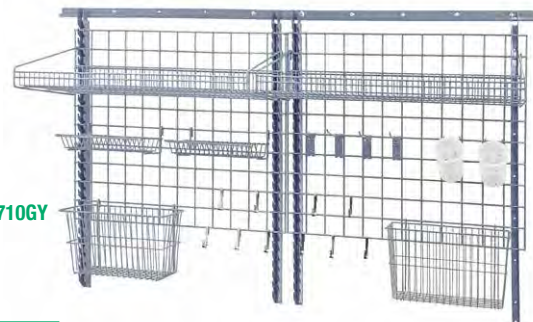

SGK-803036-1P

Medium-Duty Task Station

- Wall storage space with 1836P wire shelves, ideal for Prep Stations
- 30" x 72" grid space
- 80" track
- Antimicrobial additive protects the epoxy coating from bacteria, mold, and mildew.

Metal finishes:

Ship Weight - 107 lbs

Unit consists of:

- 2 - Wall Track - **SG-WT40P**
- 3 - Upright - **SG-U44P**
- 2 - Single Cantilever Arm - **SG-CS18P**
- 1 - Double Cantilever Arm - **SG-CD18P**
- 2 - Shelf 18" x 36" - **1836P**
- 2 - Wire Grid - **SG-3036P**
- 1 - Shelf 18" x 36" - **SG-LS1836P**
- 1 - Basket 17-3/8" x 7-1/2" x 5" - **SG-B1775P**
- 3 - Utility Rack - **SG-SR2254P**
- 1 - Utensil Holder - **SG-UH10P**
- 2 - Hook - **SG-HOOK6P**

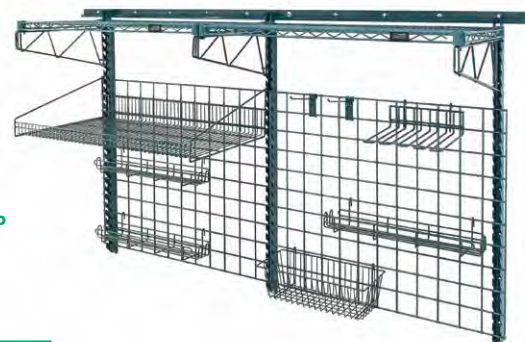

SGK-961830-1GY

Medium-Duty Task Station

- Wall storage space with 1830P wire shelves
- 96" track
- Antimicrobial additive protects the epoxy coating from bacteria, mold, and mildew.

Metal finishes:

Ship Weight - 99 lbs

Unit consists of:

- 1 - Wall Track - **SG-WT56GY**
- 1 - Wall Track - **SG-WT40GY**
- 4 - Upright - **SG-U31GY**
- 4 - Single Cantilever Arm - **SG-CS18GY**
- 4 - Double Cantilever Arm - **SG-CD18GY**
- 6 - Shelf 18" x 30" - **1830GY**



SG-A1

Accessory Pack 1

- Fits a minimum of 18" x 36" grid space

Kit consists of:

- 1 - Basket 17-3/8" x 7-1/2" x 5" - **SG-B1775P**
- 1 - Drying Rack - **SG-LH1384P**
- 1 - Flatware Cylinder - **SG-CH**
- 1 - Cylinder Holder - **SG-CMBP**
- 2 - Hook - **SG-HOOK6P**
- 6 - Hook - **SG-HOOKSM**

Ship Weight - 22 lbs

Metal finishes:



SG-A2

Accessory Pack 2

- Fits a minimum of 18" x 36" grid space

Kit consists of:

- 2 - Basket 17-3/8" x 7-1/2" x 5" - **SG-B1775P**
- 2 - Hook - **SG-HOOK6P**
- 6 - Hook - **SG-HOOKSM**
- 1 - Shelf 9" x 18" - **SG-S918P**
- 1 - Bin 10-7/8" x 5-1/2" x 5" - **QUS230**
- 1 - Bin Holder - **SG-SBH**

Ship Weight - 25 lbs

Metal finishes:

Bin available in:

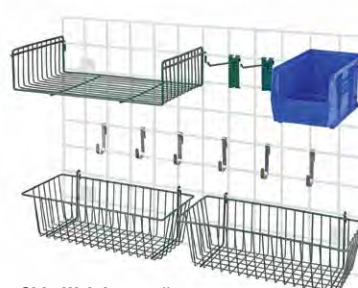



Store Grid Accessories

Metal finishes: P GY SS

PROFORM MODEL NO.	GRAY MODEL NO.	DESCRIPTION	CTN QTY	CTN WGT
Shelves				
A SG-S918P	SG-S918GY	9" x 18" Shelf with Side Ledge	1	7 lbs
B SG-LS1436P	SG-LS1436GY	14" x 36" Large Grid Shelf with Front Ledge	1	8 lbs
SG-LS1448P	SG-LS1448GY	14" x 48" Large Grid Shelf with Front Ledge	1	10 lbs
SG-LS1830P	SG-LS1830GY	18" x 30" Large Grid Shelf with Front Ledge	1	9 lbs
SG-LS1836P	SG-LS1836GY	18" x 36" Large Grid Shelf with Front Ledge	1	10 lbs
SG-LS1848P	SG-LS1848GY	18" x 48" Large Grid Shelf with Front Ledge	1	13 lbs
C SG-S1224P	SG-S1224GY	12" x 24" Small Grid Shelf	1	6 lbs
D SG-S1616P	SG-S1616GY	16" x 16" Square Grid Shelf	1	5 lbs
Baskets				
E SG-B1357P	SG-B1357GY	13-3/8" x 5" x 7" Basket	1	9 lbs
F SG-B1775P	SG-B1775GY	17-3/8" x 7-1/2" x 5" Basket	1	7 lbs
G SG-B17710P	SG-B17710GY	17-3/8" x 7-1/2" x 10" Basket	1	11 lbs
Hooks				
H SG-HOOKSM-2	SG-HOOKSMGY-2	J Small Hook (2 pack)	1	2 lbs
I SG-HOOKLG-2	SG-HOOKLGGY-2	J Shaped Large Hook (2 pack)	1	2 lbs
J SG-HOOKDB	SG-HOOKDBGY	J Double Large Hook	1	1 lb
K SG-HOOK6P-2	SG-HOOK6GY-2	6" Hook (2 pack)	1	2 lbs
L SG-HA5P	-	Hook Arm	1	1 lb
Drying Racks				
M SG-TDR341410P	SG-TDR341410GY	36" Tray Drying Rack	1	12 lbs
SG-TDR461410P	SG-TDR461410GY	48" Tray Drying Rack	1	13 lbs
N SG-SLH201412P	SG-SLH201412GY	Slanted Lid Holder/Drying Shelf	1	5 lbs
O SG-LH1384P	SG-LH1384GY	Lid Holder/Drying Shelf	1	2 lbs
P SG-BR6P	SG-BR6GY	6-Prong Bottle Rack	1	2 lbs
Utensil Holders				
Q SG-UH10P	SG-UH10GY	Large Utensil Holder	1	4 lbs
R SG-UH4P	SG-UH4GY	Small Utensil Holder	1	4 lbs
S SG-CMBP	SG-CMBGY	Cylinder Holder Mounting Bracket	1	1 lb
T SG-CH	-	Flatware Cylinder	1	1 lb
Bin Holders				
U SG-SBH	-	3"L x 3/4"W x 1-1/16"H - usable hanging space: 3" - Single Bin Holder	1	1 lb
V SG-SMBH	-	11-5/8"L x 3/4"W x 3-5/8"H - usable hanging space: 9-1/8" - Small Bin Holder	1	1 lb
W SG-LGBH	-	23-5/8"L x 3/4"W x 3-5/8"H - usable hanging space: 18-2/8" - Large Bin Holder	1	2 lbs
Miscellaneous				
X SG-SR2254P	SG-SR2254GY	Spice Rack Utility Rack	1	4 lbs
Y SG-IPH	-	Insert Pan Holder Plated	1	2 lbs
Z SG-HFF	-	Hanging File Folder Plated	1	3 lbs
AA SG-GBHP	SG-GBHGY	Glove Box Holder	1	2 lbs
AB SG-BH29P	SG-BH29GY	Book Holder 2" x 9"	1	3 lbs
AC SG-HOLDERP	SG-HOLDERGY	Paper Towel Holder	1	3 lbs

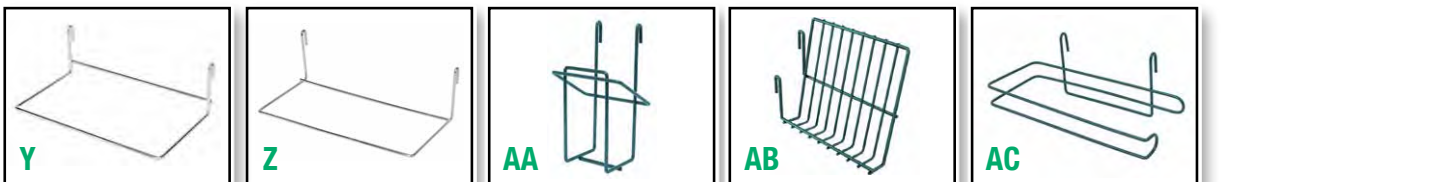
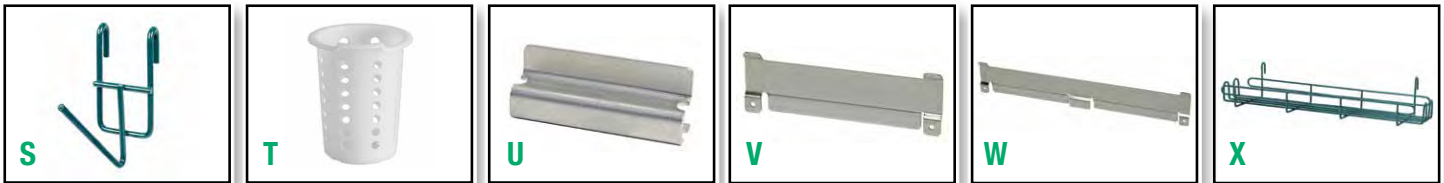

CUSTOMIZABLE CONFIGURATIONS USING A VARIETY OF ACCESSORIES



Cantilever Single Shelf Wall Mount



DWB12, DWB14, DWB18, DWB21 or DWB24
Wire Cantilever Arm

AVAILABLE FINISHES

- ◆ CHROME
- ◆ EPOXY GREEN P
- ◆ EPOXY GRAY GY
- ◆ EPOXY BLACK BK

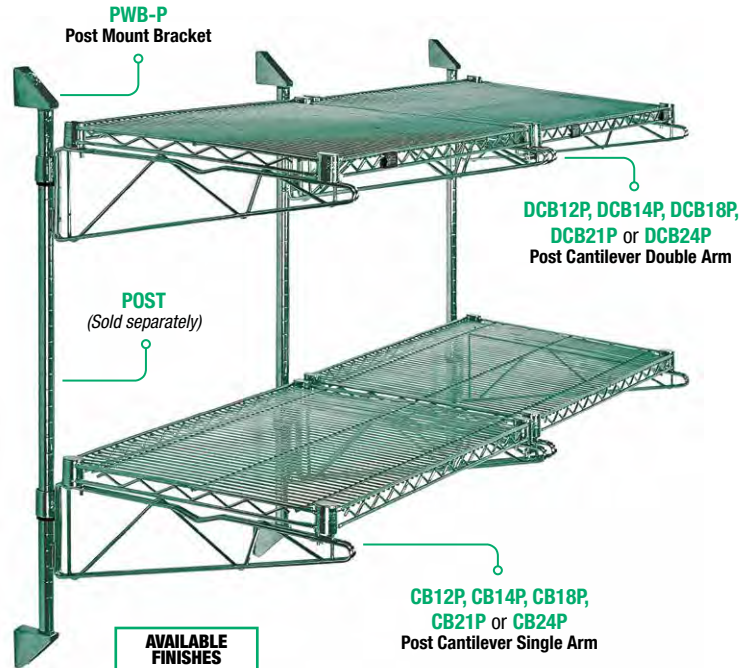

PWB-P
Post Mount Bracket

DCB12P, DCB14P, DCB18P, DCB21P or DCB24P
Post Cantilever Double Arm

POST
(Sold separately)

CB12P, CB14P, CB18P, CB21P or CB24P
Post Cantilever Single Arm

AVAILABLE FINISHES

- ◆ CHROME
- ◆ STAINLESS S
- ◆ EPOXY GREEN P
- ◆ EPOXY GRAY GY
- ◆ EPOXY BLACK BK

PWB
PWB-P
PWB-GY
PWB-BK

Post Mount Bracket

Used to secure cantilever post mount units and free standing shelving units to wall.
Sold in a pack of 4.
(Mounting screws are not included)



TO ORDER THIS EXACT CONFIGURATION, YOU WOULD ORDER THE FOLLOWING:

- 2 - CB18P
- 2 - DCB18P
- 4 - 1836P
- 3 - P34P

To further extend the configuration shown by an additional section to the left or right, simply order:

- 2 - DCB18P
- 2 - 1836P
- 1 - P34P

To further extend the configuration shown by an additional shelf level, simply order:

- 1 - CB18P
- 1 - DCB18P
- 2 - 1836P

Your options are unlimited.

TO CHOOSE FINISH ADD FINISH SUFFIX TO MODEL NO. Ex. DWB12P

MODEL NO.	DESCRIPTION	SHIP WGT
Chrome Cantilever Arms and Mounting Brackets		
DWB12	2 - 12" Cantilever Arms & 2 Mounting Brackets	3 lbs
DWB14	2 - 14" Cantilever Arms & 2 Mounting Brackets	3 lbs
DWB18	2 - 18" Cantilever Arms & 2 Mounting Brackets	4 lbs
DWB21	2 - 21" Cantilever Arms & 2 Mounting Brackets	5 lbs
DWB24	2 - 24" Cantilever Arms & 2 Mounting Brackets	5 lbs
Proform Green, Gray & Black Epoxy Cantilever Arms and Mounting Brackets		
DWB12 (P, GY, BK)	2 - 12" Epoxy Cantilever Arms & 2 Mounting Brackets	3 lbs
DWB14 (P, GY, BK)	2 - 14" Epoxy Cantilever Arms & 2 Mounting Brackets	3 lbs
DWB18 (P, GY, BK)	2 - 18" Epoxy Cantilever Arms & 2 Mounting Brackets	4 lbs
DWB21 (P, GY, BK)	2 - 21" Epoxy Cantilever Arms & 2 Mounting Brackets	5 lbs
DWB24 (P, GY, BK)	2 - 24" Epoxy Cantilever Arms & 2 Mounting Brackets	5 lbs
Chrome Double Cantilever Arm and Mounting Bracket		
DWBD12	1 - 12" Double Cantilever Arm & Mounting Bracket	3 lbs
DWBD14	1 - 14" Double Cantilever Arm & Mounting Bracket	3 lbs
DWBD18	1 - 18" Double Cantilever Arm & Mounting Bracket	4 lbs
DWBD21	1 - 21" Double Cantilever Arm & Mounting Bracket	5 lbs
DWBD24	1 - 24" Double Cantilever Arm & Mounting Bracket	5 lbs
Proform Green, Gray & Black Epoxy Double Cantilever Arm and Mounting Bracket		
DWBD12 (P, GY, BK)	1 - 12" Epoxy Double Cantilever Arm & Mounting Bracket	3 lbs
DWBD14 (P, GY, BK)	1 - 14" Epoxy Double Cantilever Arm & Mounting Bracket	3 lbs
DWBD18 (P, GY, BK)	1 - 18" Epoxy Double Cantilever Arm & Mounting Bracket	4 lbs
DWBD21 (P, GY, BK)	1 - 21" Epoxy Double Cantilever Arm & Mounting Bracket	5 lbs
DWBD24 (P, GY, BK)	1 - 24" Epoxy Double Cantilever Arm & Mounting Bracket	5 lbs

Cantilever Multiple Shelf Post Wall Mount



Adjustable post wall mount systems use a post cantilever single arm of 12", 14", 18", 21" or 24" with appropriate shelf size and post height. Two post cantilever single arms and 4 post mount brackets are included per order.

Post Cantilever Double Arm is available in 12", 14", 18", 21" and 24" and uses the center post for continuous or add-on shelf sections. One post cantilever double arm and 2 post mount brackets are included per order. Wire shelves and posts are sold separately.

TO CHOOSE FINISH ADD FINISH SUFFIX TO MODEL NO. Ex. CB12P

MODEL NO.	DESCRIPTION	SHIP WGT
Chrome Single Post Cantilever Arms		
CB12	2 - 12" Single Post Cantilever Arms & 4 Post Mount Brackets	4 lbs
CB14	2 - 14" Single Post Cantilever Arms & 4 Post Mount Brackets	5 lbs
CB18	2 - 18" Single Post Cantilever Arms & 4 Post Mount Brackets	6 lbs
CB21	2 - 21" Single Post Cantilever Arms & 4 Post Mount Brackets	7 lbs
CB24	2 - 24" Single Post Cantilever Arms & 4 Post Mount Brackets	8 lbs
Proform Green, Gray & Black Epoxy Single Post Cantilever Arms		
CB12 (P, GY, BK)	2 - 12" Single Post Cantilever Arms & 4 Post Mount Brackets	4 lbs
CB14 (P, GY, BK)	2 - 14" Single Post Cantilever Arms & 4 Post Mount Brackets	5 lbs
CB18 (P, GY, BK)	2 - 18" Single Post Cantilever Arms & 4 Post Mount Brackets	6 lbs
CB21 (P, GY, BK)	2 - 21" Single Post Cantilever Arms & 4 Post Mount Brackets	7 lbs
CB24 (P, GY, BK)	2 - 24" Single Post Cantilever Arms & 4 Post Mount Brackets	8 lbs
Stainless Steel Single Post Cantilever Arms		
CB14S	2 - 14" Single Post Cantilever Arms & 4 Post Mount Brackets	5 lbs
CB18S	2 - 18" Single Post Cantilever Arms & 4 Post Mount Brackets	6 lbs
Chrome Double Post Cantilever Arms		
DCB12	1 - 12" Double Post Cantilever Arm & 2 Post Mount Brackets	10 lbs
DCB14	1 - 14" Double Post Cantilever Arm & 2 Post Mount Brackets	11 lbs
DCB18	1 - 18" Double Post Cantilever Arm & 2 Post Mount Brackets	12 lbs
DCB21	1 - 21" Double Post Cantilever Arm & 2 Post Mount Brackets	13 lbs
DCB24	1 - 24" Double Post Cantilever Arm & 2 Post Mount Brackets	14 lbs
Proform Green, Gray & Black Epoxy Double Post Cantilever Arms		
DCB12 (P, GY, BK)	1 - 12" Double Post Cantilever Arm & 2 Post Mount Brackets	10 lbs
DCB14 (P, GY, BK)	1 - 14" Double Post Cantilever Arm & 2 Post Mount Brackets	11 lbs
DCB18 (P, GY, BK)	1 - 18" Double Post Cantilever Arm & 2 Post Mount Brackets	12 lbs
DCB21 (P, GY, BK)	1 - 21" Double Post Cantilever Arm & 2 Post Mount Brackets	13 lbs
DCB24 (P, GY, BK)	1 - 24" Double Post Cantilever Arm & 2 Post Mount Brackets	14 lbs



Direct Wall Mount Cantilever Single Shelf
Complete Packages



Versatile hanging system, ideal to create storage space in difficult spaces to accompany floor storage. Select from five different depths: 12", 14", 18", 21" or 24".

TO CHOOSE FINISH ADD FINISH SUFFIX TO MODEL NO. Ex. **WDWB1224P**

MODEL NO.	DIMENSION W" x L"	SHIP WGT
WDWB1224	12" x 24"	9 lbs
WDWB1230	12" x 30"	9 lbs
WDWB1236	12" x 36"	10 lbs
WDWB1242	12" x 42"	11 lbs
WDWB1248	12" x 48"	12 lbs
WDWB1260	12" x 60"	17 lbs
WDWB1272	12" x 72"	20 lbs
WDWB1424	14" x 24"	9 lbs
WDWB1430	14" x 30"	10 lbs
WDWB1436	14" x 36"	11 lbs
WDWB1442	14" x 42"	13 lbs
WDWB1448	14" x 48"	14 lbs
WDWB1454	14" x 54"	15 lbs
WDWB1460	14" x 60"	17 lbs
WDWB1472	14" x 72"	20 lbs
WDWB1824	18" x 24"	11 lbs
WDWB1830	18" x 30"	12 lbs
WDWB1836	18" x 36"	14 lbs
WDWB1842	18" x 42"	15 lbs
WDWB1848	18" x 48"	18 lbs
WDWB1854	18" x 54"	19 lbs
WDWB1860	18" x 60"	21 lbs
WDWB1872	18" x 72"	24 lbs
WDWB2124	21" x 24"	13 lbs
WDWB2130	21" x 30"	14 lbs
WDWB2136	21" x 36"	16 lbs
WDWB2142	21" x 42"	17 lbs
WDWB2148	21" x 48"	19 lbs
WDWB2154	21" x 54"	21 lbs
WDWB2160	21" x 60"	23 lbs
WDWB2172	21" x 72"	29 lbs
WDWB2424	24" x 24"	14 lbs
WDWB2430	24" x 30"	16 lbs
WDWB2436	24" x 36"	18 lbs
WDWB2442	24" x 42"	20 lbs
WDWB2448	24" x 48"	21 lbs
WDWB2454	24" x 54"	23 lbs
WDWB2460	24" x 60"	26 lbs
WDWB2472	24" x 72"	31 lbs

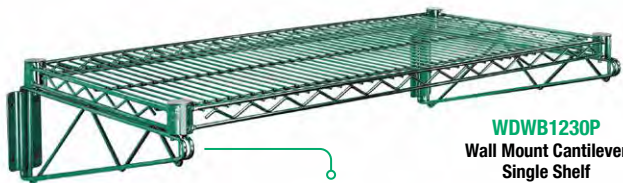

WDWB1230P
Wall Mount Cantilever Single Shelf

DWB12P, DWB14P, DWB18P, DWB21P or DWB24P
Wire Cantilever Arm

AVAILABLE FINISHES

- ◆ CHROME C
- ◆ EPOXY GREEN P
- ◆ EPOXY GRAY GY
- ◆ EPOXY BLACK BK

QUICK, EASY ASSEMBLY

Post Wall Mount Cantilever with Baskets
Complete Packages

Modular Wire Baskets mount to standard post to utilize wall space efficiently. Baskets allow for high visibility and quick accessibility. Baskets are adjustable and removable. **Finish:** Chrome

MODEL NO.	NO. OF BASKETS	BASKET MODEL NO.	BASKET DIMENSIONS W" x L" x H"	SHIP WGT
34"H - Wire Cantilever with Baskets - Complete Packages				
CAN-34-1436BC-PWB	2	1436BC	14" x 36" x 9"	26 lbs
CAN-34-1448BC-PWB	2	1448BC	14" x 48" x 9"	32 lbs
CAN-34-2036BC-PWB	2	2036BC	20" x 36" x 9"	30 lbs
CAN-34-2048BC-PWB	2	2048BC	20" x 48" x 9"	36 lbs
CAN-34-203612BC-PWB	2	203612BC	20" x 36" x 12"	34 lbs
CAN-34-204812BC-PWB	2	204812BC	20" x 48" x 12"	38 lbs



OPTIONAL DIVIDERS AVAILABLE

TURN EMPTY WALLS INTO STORAGE SPACE

CAN-34-1436BC-PWB
Baskets shown with Clear Label Holder
(Sold separately)

COMPLETE PACKAGES WITH BASKETS



SCH1
Collar Hooks
Hooks onto basket corner allowing basket to securely hang. See [pg.32](#)

Post Wall Mount Cantilever with Bin Holders
Complete Packages

Easy access, adjustable wall mounted bin systems. Available in 24", 30", 36", 48" and 60" widths. Optional bin dividers, windows fronts and clear label holders. **Finish:** Chrome

Bin available in: ● Blue ● Green ● Ivory ● Red ● Yellow ● Black ● Clear

MODEL NO.	NO. OF BIN RAILS	DIMENSIONS L" x H"	NO. OF BINS	BIN DIMENSIONS L" x W" x H"	SHIP WGT
Wire Cantilever Bin Holder - Complete with Bins Available in Blue, Green, Ivory, Red, Yellow, Black and Clear					
CAN-34-24BH-230	3	24" x 34"	9 QUS230	10-7/8" x 5-1/2" x 5"	18 lbs
CAN-34-30BH-230	3	30" x 34"	12 QUS230	10-7/8" x 5-1/2" x 5"	20 lbs
CAN-34-36BH-230	3	36" x 34"	18 QUS230	10-7/8" x 5-1/2" x 5"	26 lbs
CAN-34-48BH-230	3	48" x 34"	24 QUS230	10-7/8" x 5-1/2" x 5"	34 lbs
CAN-34-60BH-230	3	60" x 34"	30 QUS230	10-7/8" x 5-1/2" x 5"	42 lbs



CAN-34-36BH-230

COMPLETE PACKAGES WITH BINS



**Post Wall Mount Cantilever Units 1, 2 & 3 Shelves
Complete Packages**

Versatile hanging system, ideal to create storage space in difficult spaces to accompany floor storage. Select from five different depths: 12", 14", 18", 21" or 24". Available in 1, 2 or 3 shelf configurations.

TO CHOOSE FINISH ADD FINISH SUFFIX TO MODEL NO. Ex. WC14-CB1224P

- AVAILABLE FINISHES**
- ◆ CHROME C
 - ◆ EPOXY GREEN P
 - ◆ EPOXY GRAY GY
 - ◆ EPOXY BLACK BK

QUICK, EASY ASSEMBLY



WC14-CB1230BK



WC34-CB1230GY



WC54-CB1230C

DIMENSION W" x L"	14" Post Wall Mount 1 Shelf			34" Post Wall Mount 2 Shelf			54" Post Wall Mount 3 Shelf		
	MODEL NO.	SHIP WGT		MODEL NO.	SHIP WGT		MODEL NO.	SHIP WGT	
12" x 24"	WC14-CB1224	13 lbs		WC34-CB1224	26 lbs		WC54-CB1224	39 lbs	
12" x 30"	WC14-CB1230	13 lbs		WC34-CB1230	26 lbs		WC54-CB1230	39 lbs	
12" x 36"	WC14-CB1236	14 lbs		WC34-CB1236	28 lbs		WC54-CB1236	42 lbs	
12" x 42"	WC14-CB1242	15 lbs		WC34-CB1242	34 lbs		WC54-CB1242	45 lbs	
12" x 48"	WC14-CB1248	16 lbs		WC34-CB1248	36 lbs		WC54-CB1248	48 lbs	
12" x 60"	WC14-CB1260	21 lbs		WC34-CB1260	38 lbs		WC54-CB1260	63 lbs	
12" x 72"	WC14-CB1272	24 lbs		WC34-CB1272	42 lbs		WC54-CB1272	72 lbs	
14" x 24"	WC14-CB1424	13 lbs		WC34-CB1424	48 lbs		WC54-CB1424	34 lbs	
14" x 30"	WC14-CB1430	14 lbs		WC34-CB1430	28 lbs		WC54-CB1430	42 lbs	
14" x 36"	WC14-CB1436	15 lbs		WC34-CB1436	30 lbs		WC54-CB1436	45 lbs	
14" x 42"	WC14-CB1442	17 lbs		WC34-CB1442	34 lbs		WC54-CB1442	51 lbs	
14" x 48"	WC14-CB1448	18 lbs		WC34-CB1448	36 lbs		WC54-CB1448	54 lbs	
14" x 54"	WC14-CB1454	19 lbs		WC34-CB1454	38 lbs		WC54-CB1454	57 lbs	
14" x 60"	WC14-CB1460	21 lbs		WC34-CB1460	42 lbs		WC54-CB1460	63 lbs	
14" x 72"	WC14-CB1472	24 lbs		WC34-CB1472	48 lbs		WC54-CB1472	72 lbs	
18" x 24"	WC14-CB1824	15 lbs		WC34-CB1824	30 lbs		WC54-CB1824	45 lbs	
18" x 30"	WC14-CB1830	16 lbs		WC34-CB1830	32 lbs		WC54-CB1830	48 lbs	
18" x 36"	WC14-CB1836	18 lbs		WC34-CB1836	36 lbs		WC54-CB1836	54 lbs	
18" x 42"	WC14-CB1842	19 lbs		WC34-CB1842	38 lbs		WC54-CB1842	57 lbs	
18" x 48"	WC14-CB1848	22 lbs		WC34-CB1848	44 lbs		WC54-CB1848	66 lbs	
18" x 54"	WC14-CB1854	23 lbs		WC34-CB1854	46 lbs		WC54-CB1854	69 lbs	
18" x 60"	WC14-CB1860	25 lbs		WC34-CB1860	50 lbs		WC54-CB1860	75 lbs	
18" x 72"	WC14-CB1872	28 lbs		WC34-CB1872	56 lbs		WC54-CB1872	84 lbs	
21" x 24"	WC14-CB2124	16 lbs		WC34-CB2124	32 lbs		WC54-CB2124	48 lbs	
21" x 30"	WC14-CB2130	17 lbs		WC34-CB2130	34 lbs		WC54-CB2130	51 lbs	
21" x 36"	WC14-CB2136	19 lbs		WC34-CB2136	38 lbs		WC54-CB2136	57 lbs	
21" x 42"	WC14-CB2142	20 lbs		WC34-CB2142	40 lbs		WC54-CB2142	60 lbs	
21" x 48"	WC14-CB2148	22 lbs		WC34-CB2148	44 lbs		WC54-CB2148	66 lbs	
21" x 54"	WC14-CB2154	24 lbs		WC34-CB2154	48 lbs		WC54-CB2154	72 lbs	
21" x 60"	WC14-CB2160	26 lbs		WC34-CB2160	52 lbs		WC54-CB2160	78 lbs	
21" x 72"	WC14-CB2172	32 lbs		WC34-CB2172	64 lbs		WC54-CB2172	96 lbs	
24" x 24"	WC14-CB2424	18 lbs		WC34-CB2424	36 lbs		WC54-CB2424	54 lbs	
24" x 30"	WC14-CB2430	20 lbs		WC34-CB2430	40 lbs		WC54-CB2430	60 lbs	
24" x 36"	WC14-CB2436	22 lbs		WC34-CB2436	44 lbs		WC54-CB2436	66 lbs	
24" x 42"	WC14-CB2442	24 lbs		WC34-CB2442	48 lbs		WC54-CB2442	72 lbs	
24" x 48"	WC14-CB2448	25 lbs		WC34-CB2448	50 lbs		WC54-CB2448	59 lbs	
24" x 54"	WC14-CB2454	27 lbs		WC34-CB2454	54 lbs		WC54-CB2454	81 lbs	
24" x 60"	WC14-CB2460	30 lbs		WC34-CB2460	60 lbs		WC54-CB2460	90 lbs	
24" x 72"	WC14-CB2472	35 lbs		WC34-CB2472	70 lbs		WC54-CB2472	105 lbs	



**Stainless Steel Work Tables
with Adjustable Undershef**



Heavy-duty 304 stainless steel processing tables are ideal for pack and prep in sterile environments. Units consist of a flat top work surface with hemmed edges and the lower flat bottom shelf is adjustable from 3" to 27" high. Tables are NSF approved. The support legs are 1-5/8" diameter with a leveling foot which can be converted to a mobile unit with a 4" stainless steel caster kit, all swivel and 2 with brake. (Sold separately) **Finish:** 304 Stainless Steel



Adjustable
from 3" - 27"
under top shelf

SST-2436U
24"W x 36"L x 34"H



SST-MOB
4" Stainless Steel Casters
Up to 1,000 lb. load capacity

MODEL NO.	DIMENSIONS W" x L" x H"	NO. OF SHELVES	SHIP WGT
Stationary Instrument Table with Shelf			
SST-2436U	24" x 36" x 34"	1	50 lbs
SST-2448U	24" x 48" x 34"	1	60 lbs
SST-2460U	24" x 60" x 34"	1	70 lbs
SST-2472U	24" x 72" x 34"	1	80 lbs
Mobile Kit			
SST-MOB	4 Swivel Casters, 2 with Brake		8 lbs



NEW

DRIVE-THRU STATION

**STORAGE
AND
ORGANIZATION
AT YOUR
FINGERTIPS**

Custom Drive-thru Station



To create this exact drive-thru station unit you would need to purchase the following parts listed below.

Unit consists of:

- 2 - 74" Post - **P74P**
- 2 - 34" Post - **P34P**
- 1 - 24" x 36" Solid Shelf - **2436SG**
- 3 - 24" x 36" Wire Shelf - **2436P**
- 2 - 18" x 36" Wire Grid - **SG-1836P**
- 2 - Post Mount Grid Bracket (Pack of 4) - **WR-PMGP**
- 1 - 14" x 36" Shelf - **SG-LS1436P**
- 5 - Ultra Bins - **QUS230CL***
- 5 - Single Bin Holder - **SG-SBH**
- 3 - Ultra Bins - **QUS235CL***
- 3 - Small Bin Holder - **SG-SMBH**

*Plastic bins must be purchased in carton quantities



NEW

WR-PMGP
Post Mount Grid Bracket
See pg. 32



QUICK AND EASY INSTALLATION



NEW
2430SSTOP
Stainless Steel Shelf Cover

Foam barrier included providing protective cushioning and helps muffle noise

Stainless Steel Shelf Covers



Constructed from durable 18 gauge 304 stainless steel, this stainless steel shelf covering offers commercial-grade resilience, engineered for extended durability. Unlike wire shelving that may permit small items to slip through or pose the risk of package leaks affecting lower shelves, this sturdy shelf covering transforms wire shelves into functional workstations, providing the versatility and dependability essential for a range of applications.

MODEL NO.	DIMENSIONS W" x L" x H"	SHIP WGT
2430SSTOP	24" x 30" x 2"	20 lbs
3030SSTOP	30" x 30" x 2"	27 lbs
3036SSTOP	30" x 36" x 2"	27 lbs
3042SSTOP	30" x 42" x 2"	28 lbs
3048SSTOP	30" x 48" x 2"	28 lbs
3060SSTOP	30" x 60" x 2"	29 lbs
3072SSTOP	30" x 72" x 2"	30 lbs

Custom Stations



Preconfigured custom station starter unit is available in 36", 48" and 60" lengths. Customize your prep or drive-thru station as needed with optional accessories shown on **pgs. 63 - 64**

MODEL NO.	DIMENSIONS W" x L" x H"	SHIP WGT
WR74-DT2436P	24" x 36" x 74"	84 lbs
WR74-DT2448P	24" x 48" x 74"	103 lbs
WR74-DT2460P	24" x 60" x 74"	126 lbs

Each unit consists of:

- 2 - 74" Post
- 2 - 34" Post
- 1 - Solid Shelf
- 2 - Wire Shelf
- 2 - Wire Grid
- 2 - Post Mount Grid Bracket (Pack of 4)
- 1 - Cantilever Shelf

**OPTIONAL
ACCESSORY
PACKS AND
ACCESSORIES
AVAILABLE**

See **pg. 63-64**

**▶ DISPLAY,
ORGANIZE,
SAVE SPACE**

**▶ MAXIMIZE
EFFICIENCY**



NEW
WR74-DT2436P

**UNIT SHOWN IS
CUSTOMIZABLE
USING A VARIETY
OF ACCESSORIES**



WR74-DT2436P + SG-A2BL



Polymer Dunnage Racks



Smooth top and rounded edges promote safe handling and protects against product damage. Open surface enables airflow, cleanability, and prevents bacteria buildup. Heavy-duty polymer construction gives racks the strength to hold up to 4,000 lbs. No assembly required. Multiple combinations enable custom storage space layouts. Racks can be loaded/unloaded easily from all sides. Withstands temperatures from -20°F to 180°F. Won't overheat or overcool. Antimicrobial additive protects against rust, corrosion, bacteria, mold, and mildew. Ideal to elevate products off of the floor in coolers, freezers, backrooms, food preparation, and storage areas. Polymer composition makes these racks resistant to rust, corrosion, and food acids. **Color:** Gray

Available in: ● Gray

MODEL NO.	DESCRIPTION	SHIP WGT
Dunnage Racks		
QFSD-2236	22"D x 36"W x 12"H - Dunnage Rack	18 lbs
QFSD-2248	22"D x 48"W x 12"H - Dunnage Rack	24 lbs
QFSD-2260	22"D x 60"W x 12"H - Dunnage Rack	28 lbs

**SAFE
SANITARY
STRONG**

**SUPERIOR CHOICE
AND STRENGTH
OVER ALUMINUM
AND OTHER
TYPE RACKS**

Up to 2,200 lb.
LOAD CAPACITY



QFSD-2236

Up to 4,000 lb.
LOAD CAPACITY



QFSD-2248

Up to 4,000 lb.
LOAD CAPACITY



QFSD-2260

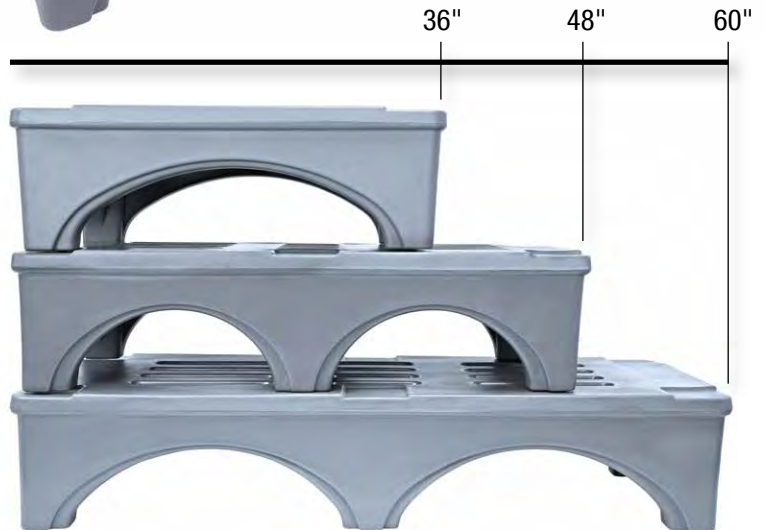



MODEL NO.	DIMENSIONS W" x L" x H"	LOAD CAPACITY	SHIP WGT
Ventilated Top			
362412DPP	24" x 36" x 12"	500 lbs	13 lbs
363612DPP	36" x 36" x 12"	750 lbs	22 lbs
482412DPP	24" x 48" x 12"	700 lbs	19 lbs
662412DPP	24" x 66" x 12"	1,000 lbs	23 lbs
663612DPP	36" x 66" x 12"	1,500 lbs	37 lbs
962412DPP	24" x 96" x 12"	1,400 lbs	34 lbs
963612DPP	36" x 96" x 12"	2,000 lbs	53 lbs
Solid Top			
362412DPS	24" x 36" x 12"	700 lbs	17 lbs
363612DPS	36" x 36" x 12"	1,000 lbs	26 lbs
482412DPS	24" x 48" x 12"	900 lbs	21 lbs
662412DPS	24" x 66" x 12"	1,400 lbs	28 lbs
663612DPS	36" x 66" x 12"	1,900 lbs	49 lbs
962412DPS	24" x 96" x 12"	1,800 lbs	41 lbs
963612DPS	36" x 96" x 12"	2,700 lbs	64 lbs

Polymer Dunnage Racks



Our Dunnage Racks are as portable as they are versatile. Made from lightweight, heavy-duty high density polyethylene, these are the perfect match for wet or chemically intense manufacturing environments. A simple snap together design makes it a breeze to raise finished goods and raw materials off the ground and away from moisture, dirt and traffic. When it comes to cleanup time, just sweep underneath! We offer the largest commercially available sizes in a high-capacity, low-cost dunnage solution that lets you reset and move workstations as often as you see fit. Plus, the grid-top design simplifies working with fluids and bagged goods because any spilled items will flow through the surface to the floor below. **Color:** Black



EASILY STORE SUPPLIES AND MATERIALS OFF THE GROUND

Expandable EZ Lock Platform Rack & Pallet



Quantum's EZ Lock platform and pallet allows you to customize your storage space in seconds. Its patented interlocking design allows true flexibility in building the exact size pallet or platform you need. Using 12" x 40" footprints, each unit locks together making this an all-purpose storage, moving, and shipping solution. Manufactured of recycled high density polyethylene, the vented deck is freezer safe and chemical resistant. Its one piece body design and structure allows for a 4 way forklift and hand truck entry, and it meets GMA industry standards. Enhances any 5S Lean initiative. Withstands temperatures from -30°F – 200°F and offers up to 2,500 lb. load capacity when connected. Once built, the structure will maintain its dimensions with no sagging or stretching. Plastic will not absorb any liquids or chemicals and is resistant to insect infestation. Perfect for use in hospitals, pharmacies, clean rooms, food and beverage areas, manufacturing environments, and supermarket and grocery store back rooms. **Color:** Black

MODEL NO.	DIMENSIONS W" x L" x H"	CTN QTY	SHIP WGT
EL-12406	12" x 40" x 6"	1 Pair (2 Pieces)	14 lbs



QUICK AND TROUBLE-FREE ASSEMBLY UP TO 2,500 LB. LOAD CAPACITY

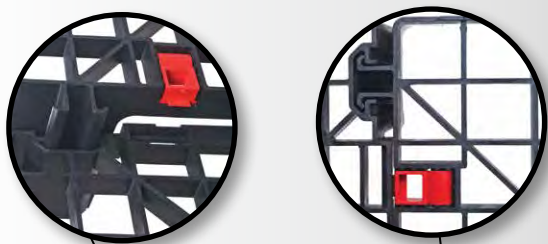

LOCKING SYSTEMS
Simple locking system allows for quick and trouble-free assembly

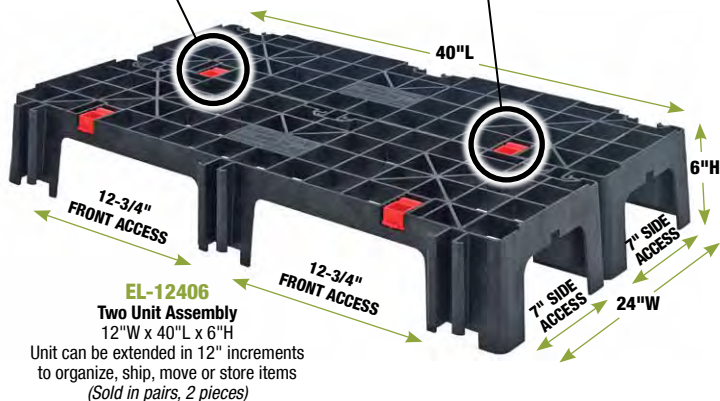

EL-12406
Two Unit Assembly
12" W x 40" L x 6" H

Unit can be extended in 12" increments to organize, ship, move or store items (Sold in pairs, 2 pieces)



STACKABLE FOR EASY STORAGE



Mobile Dunnage Platform Racks



Units can be used for moving case goods and other heavy items for cleaning, warehouse and stock room applications. Non-marking casters add flexibility. **Finish:** Gray Epoxy

Each unit consists of:

- 4 - 6" posts
- 1 - 3 sided frame
- 1 - dunnage shelf
- 4 - 5" swivel thermoplastic resin casters, 2 with brakes
- 4 - donut bumpers

MODEL NO.	DIMENSIONS W" x L" x H"	SHIP WGT
M18246DGY	18" x 24" x 12"	36 lbs
M18306DGY	18" x 30" x 12"	40 lbs
M18366DGY	18" x 36" x 12"	44 lbs
M18426DGY	18" x 42" x 12"	48 lbs
M18486DGY	18" x 48" x 12"	52 lbs
M18606DGY	18" x 60" x 12"	59 lbs
M24246DGY	24" x 24" x 12"	39 lbs
M24306DGY	24" x 30" x 12"	44 lbs
M24366DGY	24" x 36" x 12"	48 lbs
M24426DGY	24" x 42" x 12"	53 lbs
M24486DGY	24" x 48" x 12"	55 lbs
M24606DGY	24" x 60" x 12"	63 lbs



M18366DGY

Up to 1,300-1,600 lb.
MOBILE LOAD CAPACITY

Modular Dunnage Racks



Ideal for extreme load capacities (up to 1,300-1,600 lb.). Includes tubular 1" square frame super structure and removable wire top mat. **Finish:** Gray Epoxy

Each unit consists of:

- 4 - 14" posts
- 1 - 3 sided frame
- 1 - dunnage shelf

MODEL NO.	DIMENSIONS W" x L" x H"	SHIP WGT
182414DGY	18" x 24" x 14"	22 lbs
183014DGY	18" x 30" x 14"	26 lbs
183614DGY	18" x 36" x 14"	30 lbs
184214DGY	18" x 42" x 14"	34 lbs
184814DGY	18" x 48" x 14"	38 lbs
186014DGY	18" x 60" x 14"	45 lbs
242414DGY	24" x 24" x 14"	25 lbs
243014DGY	24" x 30" x 14"	30 lbs
243614DGY	24" x 36" x 14"	34 lbs
244214DGY	24" x 42" x 14"	39 lbs
244814DGY	24" x 48" x 14"	41 lbs
246014DGY	24" x 60" x 14"	49 lbs



183614DGY

Up to 1,300-1,600 lb.
LOAD CAPACITY

Shelf Platform Racks



Represents an ergonomic solution for keeping case goods off the floor. Platforms are often used at workstations and prep storage areas. **Finishes:** Chrome and Proform Green Epoxy

Each unit consists of:

- 4 - 14" posts
- 1 - shelf

CHROME MODEL NO.	GREEN MODEL NO.	DIMENSIONS W" x L" x H"	SHIP WGT
183614PC	183614PP	18" x 36" x 14"	14 lbs
184814PC	184814PP	18" x 48" x 14"	18 lbs
186014PC	186014PP	18" x 60" x 14"	21 lbs
243614PC	243614PP	24" x 36" x 14"	17 lbs
244814PC	244814PP	24" x 48" x 14"	20 lbs
246014PC	246014PP	24" x 60" x 14"	25 lbs



183614PC

Up to 600-800 lb.
LOAD CAPACITY PER SHELF

Keg Racks



Quantum Food Service Keg Rack and Dunnage Platforms are the most cost-effective, durable, and efficient storage solution in the industry. The solution accommodates the irregular shape of the keg rounds and is perfect for getting all bulk items off the floor. These systems provide maximum storage space, inventory management, and efficiency in the cooler and other storage spaces.

The open and removable wire decking design of these racks shelves minimizes dust accumulation while keeping the kegs off of the floor for cleanliness. It also offers an easier and neat way of handling kegs, barrels, and cases. Multiple kegs can be stored in series allowing the handling of more brands. All racks come in gray epoxy antimicrobial finish, which represents an ideal solution for high humidity, wet, or walk-in-cooler applications (15 year warranty). **Finish:** Gray Epoxy



MODEL NO.	DIMENSIONS W" x L" x H"	SHIP WGT	WGT CAP	KEGS* CAP
1 Shelf				
182434DGY	18" x 24" x 34"	26 lbs	1,600 lbs	1
183034DGY	18" x 30" x 34"	30 lbs	1,600 lbs	1
183634DGY	18" x 36" x 34"	34 lbs	1,600 lbs	2
184234DGY	18" x 42" x 34"	38 lbs	1,600 lbs	2
184834DGY	18" x 48" x 34"	42 lbs	1,600 lbs	3
186034DGY	18" x 60" x 34"	49 lbs	1,300 lbs	3
242434DGY	24" x 24" x 34"	29 lbs	1,600 lbs	1
243034DGY	24" x 30" x 34"	34 lbs	1,600 lbs	1
243634DGY	24" x 36" x 34"	38 lbs	1,600 lbs	2
244234DGY	24" x 42" x 34"	43 lbs	1,600 lbs	2
244834DGY	24" x 48" x 34"	45 lbs	1,600 lbs	3
246034DGY	24" x 60" x 34"	55 lbs	1,300 lbs	3

* Half barrel size keg

Up to 1,300-1,600 lb.
LOAD CAPACITY

MAXIMUM STORAGE SPACE

MODEL NO.	DIMENSIONS W" x L" x H"	SHIP WGT	WGT CAP	KEGS* CAP
2 Shelf				
182454DGY	18" x 24" x 54"	48 lbs	3,200 lbs	2
183054DGY	18" x 30" x 54"	56 lbs	3,200 lbs	2
183654DGY	18" x 36" x 54"	64 lbs	3,200 lbs	4
184254DGY	18" x 42" x 54"	72 lbs	3,200 lbs	4
184854DGY	18" x 48" x 54"	80 lbs	3,200 lbs	6
186054DGY	18" x 60" x 54"	94 lbs	2,600 lbs	6
242454DGY	24" x 24" x 54"	54 lbs	3,200 lbs	2
243054DGY	24" x 30" x 54"	34 lbs	3,200 lbs	2
243654DGY	24" x 36" x 54"	72 lbs	3,200 lbs	4
244254DGY	24" x 42" x 54"	82 lbs	3,200 lbs	4
244854DGY	24" x 48" x 54"	86 lbs	3,200 lbs	6
246054DGY	24" x 60" x 54"	106 lbs	2,600 lbs	6

* Half barrel size keg

Up to 2,600-3,200 lb.
LOAD CAPACITY

WEIGHT CAPACITY BASED ON EVEN LOAD DISTRIBUTION PER SHELF



183634DGY

Each 1 Shelf unit consists of:
4 - 34" posts
1 - 3 sided frame
1 - dunnage shelf



183654DGY

Each 2 Shelf unit consists of:
4 - 54" posts
2 - 3 sided frame
2 - dunnage shelf



FIRST POSITION
Flat



SECOND POSITION
10° slope



THIRD POSITION
30° slope



**ADJUSTABLE BRACKETS
ALLOW YOU TO CHOOSE
YOUR IDEAL POSITION
AND EASIEST ACCESS
TO STORED PRODUCT**

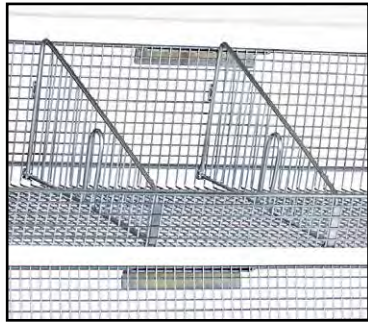

**COMPLETE
PACKAGES
WITH BASKETS**

DIVIDERS

Basket divider allows you to quickly and easily organize the contents of your basket unit by creating separate compartments within each basket (Sold separately)



WS70-SS36-4S3L
Shown with dividers
(Sold separately)

Partition Wall Systems - Complete Packages

PARTition Wall Hanging Baskets are uniquely designed for instant visibility and easy access while maximizing your storage area. The wire construction minimizes dirt accumulation and allows air circulation. Baskets have a 1/2" x 1/2" grid pattern to partition product while letting you know when to reorder product and restock items. Available in 11-7/8" and 17-7/8" widths, and in 18", 36", and 48" lengths. **Finish:** Chrome

STARTER UNITS		ADD-ON		BASKET		ACCESSORIES		
MODEL NO.	SHIP WGT	MODEL NO.	SHIP WGT	MODEL NO.	NO. OF BASKET	DIVIDER MODEL NO.	LABEL HOLDERS MODEL NO.	DUST SHELF MODEL NO.
18" - Single Sided Systems - Complete with Baskets								
WS70-SS18-7S	83 lbs	WS70-SS18AD-7S	71 lbs	1017HBC	7	1006DHB/1006DHB-SQ	HBL165C	WS-1218DSHC
WS70-SS18-4S3L	86 lbs	WS70-SS18AD-4S3L	86 lbs	1017HBC 1617HBC	4 3	1006DHB/1006DHB-SQ 1606DHB/1606DHB-SQ	HBL165C HBL165C	WS-1818DSHC
36" - Single Sided Systems - Complete with Baskets								
WS70-SS36-7S	117 lbs	WS70-SS36AD-7S	105 lbs	1035HBC	7	1006DHB/1006DHB-SQ	HBL345C	WS-1236DSHC
WS70-SS36-4S3L	123 lbs	WS70-SS36AD-4S3L	111 lbs	1035HBC 1635HBC	4 3	1006DHB/1006DHB-SQ 1606DHB/1606DHB-SQ	HBL345C HBL345C	WS-1836DSHC
48" - Single Sided Systems - Complete with Baskets								
WS70-SS48-7S	131 lbs	WS70-SS48AD-7S	119 lbs	1047HBC	7	1006DHB/1006DHB-SQ	HBL465C	WS-1248DSHC
WS70-SS48-4S3L	140 lbs	WS70-SS48AD-4S3L	128 lbs	1047HBC 1647HBC	4 3	1006DHB/1006DHB-SQ 1606DHB/1606DHB-SQ	HBL465C HBL465C	WS-1848DSHC



Starter Units

Starter units come complete with two uprights and three tie-bars.



WS70-SS18HC

WS70-SS36HC

WS70-SS48HC

Add-On Units

Add-On units allow you to expand your Starter unit by sharing an upright. Add-On unit includes one common upright and three tie-bars.

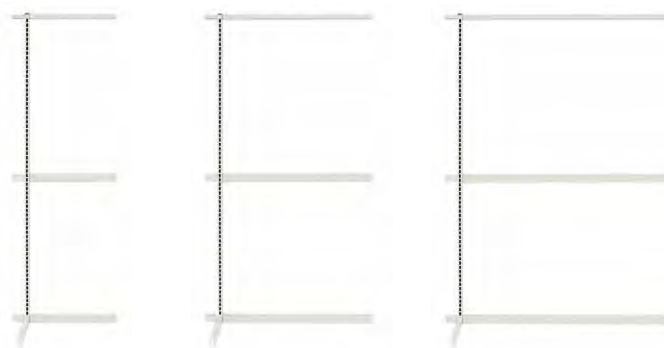

WS70-SS18ADHC

WS70-SS36ADHC

WS70-SS48ADHC

L"	STARTER UNITS		ADD-ON UNITS		ACCESSORIES				
	MODEL NO.	SHIP WGT	MODEL NO.	SHIP WGT	HANG BAR MODEL NO.	12" DUST SHELF MODEL NO.	18" DUST SHELF MODEL NO.	LOUVERED PANEL MODEL NO.	PANEL FRAME* MODEL NO.
Single Sided Units									
18"	WS70-SS18HC	31 lbs	WS70-SS18ADHC	31 lbs	-	WS-1218DSHC	WS-1818DSHC	QLP-1861HC	WS-PM18HC
36"	WS70-SS36HC	37 lbs	WS70-SS36ADHC	25 lbs	WS-HB36HC	WS-1236DSHC	WS-1836DSHC	QLP-3661HC	WS-PM36HC
48"	WS70-SS48HC	42 lbs	WS70-SS48ADHC	30 lbs	WS-HB48HC	WS-1248DSHC	WS-1848DSHC	QLP-4861HC	WS-PM48HC
Double Sided Units									
18"	WS70-DS18HC	34 lbs	WS70-DS18ADHC	21 lbs	-	WS-1218DSHC	WS-1818DSHC	QLP-1861HC	WS-PM18HC
36"	WS70-DS36HC	40 lbs	WS70-DS36ADHC	27 lbs	WS-HB36HC	WS-1236DSHC	WS-1836DSHC	QLP-3661HC	WS-PM36HC
48"	WS70-DS48HC	45 lbs	WS70-DS48ADHC	32 lbs	WS-HB48HC	WS-1248DSHC	WS-1848DSHC	QLP-4861HC	WS-PM48HC

*Required to mount louvered panels

CUSTOMIZE YOUR OWN UNIT

For Units using Hanging Baskets:

1. Determine total space you want to fill from left to right
2. Select a Starter Unit (either 18", 36" or 48" wide)
3. Fill remaining space by utilizing Add-On Units
4. Determine how many basket levels you want to have per unit, which will correspond to the total number of brackets needed
5. Dividers and label holders are available for all basket sizes

For Units using Louvered Panels:

1. Determine total space you want to fill from left to right
2. Select a Starter Unit (either 18", 36" or 48" wide)
3. Fill remaining space by utilizing Add-On Units
4. Each unit (both Starter or Add-On) will fit a corresponding 18", 36" or 48" louvered panel (**note:** Louvered panel requires one panel frame)
5. Louvered panel will accommodate:
 - **Hanging Baskets** - available on pg. 75
 - **Clear Tip Out Bins** - available on pg. 132 (**note:** one hanging bracket pair QTB-LP-BKT is needed per Tip Out Bin)
 - **Mesh Bins** - available on pg. 98
 - **Plastic Bins** - available on pgs. 93, 96 and 100

Hanging Baskets

- 125 lb. load capacity per basket (up to twice as strong as plastic bins)
- Mesh design ensures no accumulation of dirt or dust and instant visibility
- Brilliant chrome finish ensures professional appearance and years of heavy-duty service
- Baskets can be divided allowing maximization of all space

UNIQUELY DESIGNED FOR HIGH VISIBILITY AND EASY ACCESS

MODEL NO.	OUTSIDE DIMENSIONS W" x L" x H"	INSIDE DIMENSIONS W" x L" x H"	SHIP WGT
Hanging Baskets			
1017HBC	11-7/8" x 18" x 7-1/2"	11" x 17-3/8" x 7"	5 lbs
1035HBC	11-7/8" x 36" x 7-1/2"	11" x 35" x 7"	9 lbs
1047HBC	11-7/8" x 48" x 7-1/2"	11" x 47" x 7"	11 lbs
1617HBC	17-7/8" x 18" x 7-1/2"	17" x 17-3/8" x 7"	6 lbs
1635HBC	17-7/8" x 36" x 7-1/2"	17" x 35" x 7"	11 lbs
1647HBC	17-7/8" x 48" x 7-1/2"	17" x 47" x 7"	14 lbs

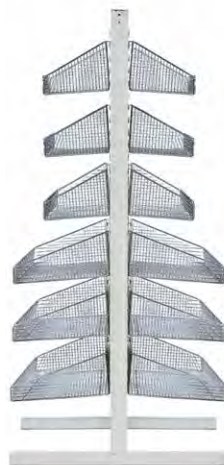

WS-DS36HC
Shown with Baskets
(Sold separately)

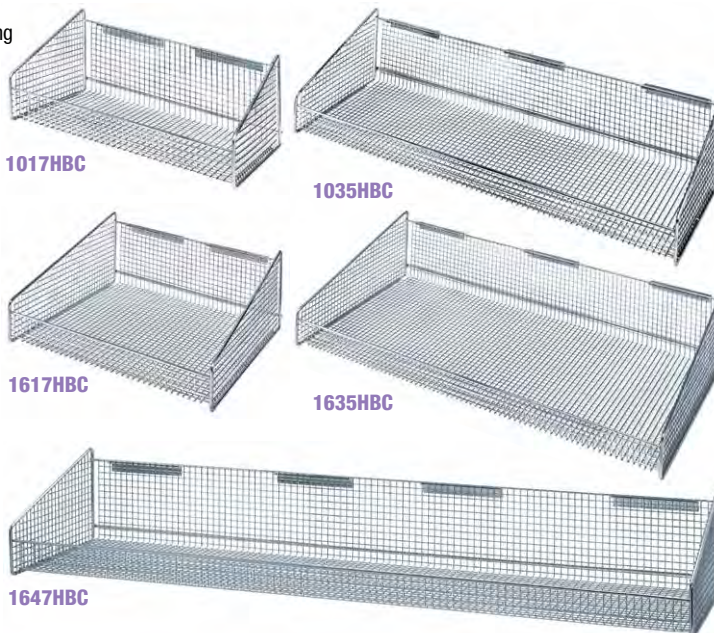



Dividers

8 SIZES AVAILABLE

MODEL NO.	DIMENSIONS W" x H"	SHIP WGT
Hanging Basket Dividers		
4X3HBD	3" x 4-1/2"	1 lb
4X6HBD	6" x 4-1/2"	1 lb
4X9HBD	9" x 4-1/2"	1 lb
4X15HBD	15" x 4-1/2"	2 lbs
1006DHB	10" x 6"	1 lb
1606DHB	16" x 6"	2 lbs
1006DHB-SQ	10" x 6"	1 lb
1606DHB-SQ	16" x 6"	2 lbs

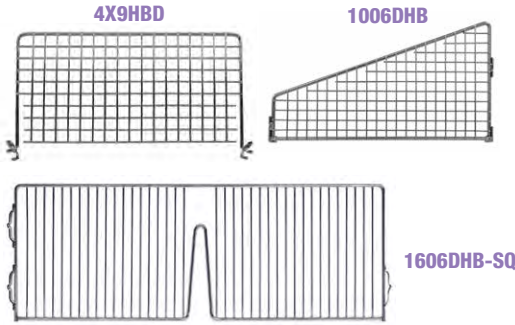

Separate product in basket with use of optional dividers. Dividers are used front to back to create individual compartments.

Clear Label Holders

Super easy method for identifying product. Affixes directly to the front on any basket. Four lengths available. (Label inserts sold separately).

MODEL NO.	DESCRIPTION	SHIP WGT
Clear Label Holders		
HBL3C	3" Clear Label Holder	1 lb
HBL165C	16-1/2" Clear Label Holder Fits 18" Basket	1 lb
HBL345C	34-1/2" Clear Label Holder Fits 36" Basket	1 lb
HBL465C	46-1/2" Clear Label Holder Fits 48" Basket	1 lb



Dust Shelves

WS-1218DSHC

MODEL NO.	DIMENSIONS W" x L"	SHIP WGT
Dust Shelves		
WS-1218DSHC	12" x 18"	5 lbs
WS-1236DSHC	12" x 36"	10 lbs
WS-1248DSHC	12" x 48"	15 lbs
WS-1818DSHC	18" x 18"	7 lbs
WS-1836DSHC	18" x 36"	15 lbs
WS-1848DSHC	18" x 48"	20 lbs

Dust Shelves not designed for load bearing

Spikes & Holders

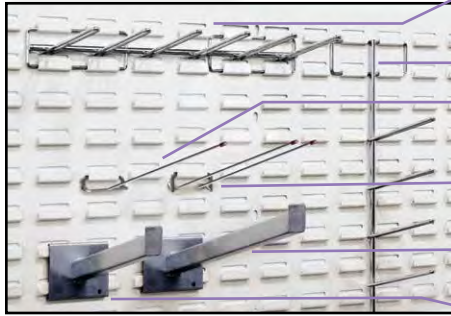

- WS-HTH**
Horizontal Tape/Reel Holder
Up to 25 lb. load capacity
- WS-VTH**
Vertical Tape/Reel Holder
Up to 25 lb. load capacity
- WS-SR9C**
9" Single Rod
Up to 15 lb. load capacity
- WS-DR10C**
10" Double Rod
Up to 15 lb. load capacity
- WS-HDS12**
Heavy-Duty 12" Spike
Up to 50 lb. load capacity
- WS-HDS6**
Heavy-Duty 6" Spike
Up to 65 lb. load capacity

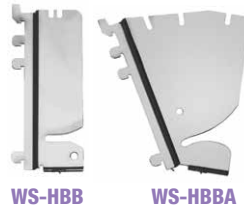

Hanging Brackets

MODEL NO.	DESCRIPTION	SHIP WGT
Hanging Brackets for Starter and Add-On Units		
WS-HBB	90° Bracket Pair (2 pcs)	1 lb
WS-HBBA	Adjustable Bracket Pair (2 pcs)	1 lb

Louvered Panels

MODEL NO.	DIMENSIONS L" x H"	SHIP WGT
Oyster White Louvered Panels		
QLP-1861HC	18" x 61"	21 lbs
QLP-3661HC	36" x 61"	40 lbs
QLP-4861HC	48" x 61"	60 lbs

Louvered Panels require panel frame in order to affix to PARTition Wall Systems



Hang Bars

Used to mount wire louvered panels on PARTition Wall Systems. Wire Panels available on [pg. 99](#)

MODEL NO.	DESCRIPTION	SHIP WGT
Hang Bars		
WS-HB36HC	36" Hang Bar	4 lbs
WS-HB48HC	48" Hang Bar	5 lbs





Bin Cart Systems

Bin carts can be used for transporting and holding product. A modular drawer system allows for storage of smaller specialty components while the open shelf design maximizes the storage area. The option of cart covers *pg. 46*, enclosure panels *pg. 30*, ledges and dividers *pg. 31* add to the flexibility of the unit. **Cart Finish:** Chrome

Bins available in: ● Blue ● Red ● Gray ● Clear (One color per unit)

MODEL NO.	NO. OF BINS	BIN DIMENSIONS L" x W" x H"	SHIP WGT
24"W x 36"L x 69"H - Bin Cart with Dividable Grids			
WRC5-63-2436-93060	4 DG93060	22-1/2" x 17-1/2" x 6"	113 lbs
24"W x 48"L x 69"H - Bin Cart with Dividable Grids			
WRC5-63-2448-93060	4 DG93060	22-1/2" x 17-1/2" x 6"	128 lbs
24"W x 60"L x 69"H - Bin Cart with Dividable Grids			
WRC5-63-2460-93060	4 DG93060	22-1/2" x 17-1/2" x 6"	153 lbs



WRC5-63-2436-93060

- Each unit consists of:
- 4 - 63" posts
 - 5 - wire shelves
 - 4 - DS18-24 bin slides
 - 4 - 5" swivel thermoplastic resin casters, 2 with brake
 - 4 - donut bumpers
 - 4 - DG93060 bins (Blue, Red, Gray or Clear)

COMPLETE PACKAGES WITH BINS



ALL MOBILE UNITS INCLUDE FOUR 5" x 1-1/4" SWIVEL CASTERS, 2 WITH BRAKES

Up to 1,200 lb. MOBILE LOAD CAPACITY



DIVIDERS

Containers can be divided by length and/or width allowing a subdivision down to a 1-1/8" square compartment size. See *pg. 123*



CLEAR ACRYLIC INLAYS

Keep stored items visible while protecting against airborne dust and other contaminants. Cover lays inside on rim of container. See *pg. 123*

Bin Carts

Offering two heights and four bin quantity designs, these modular carts are the ultimate work-in-process and transport carts. Dividable grids slide easily in and out and with their ability to be divided into multiple compartments with long and short dividers, truly any type of storage is possible, see *pg. 123* for dividers and label holders. **Cart Finish:** Chrome

Bins available in: ● Blue ● Red ● Gray ● Clear (One color per unit)

MODEL NO.	NO. OF BINS	BIN DIMENSIONS L" x W" x H"	SHIP WGT
21"W x 24"L x 45"H - Bin Cart with Dividable Grid Containers			
BC212434M1	4 DG93060	22-1/2" x 17-1/2" x 6"	58 lbs
BC212439M2	7 DG93030	22-1/2" x 17-1/2" x 3"	79 lbs
21"W x 24"L x 69"H - Bin Cart with Dividable Grid Containers			
BC212469M1	7 DG93060	22-1/2" x 17-1/2" x 6"	107 lbs
BC212469M2	11 DG93030	22-1/2" x 17-1/2" x 3"	111 lbs
21"W x 24"L x 45"H - Bin Cart with No Dividable Grid Containers			
BC212439M4	No Containers (includes slides for 4 bin levels)		46 lbs
BC212439M7	No Containers (includes slides for 7 bin levels)		55 lbs
21"W x 24"L x 69"H - Bin Cart with No Dividable Grid Containers			
BC212469M	No Containers (includes slides for 7 bin levels)		63 lbs
BC212469M11	No Containers (includes slides for 11 bin levels)		75 lbs
WR-S24W	-	-	3 lbs



BC212434M1



BC212469M1



Work Station Carts - The ideal work-in-process cart

The sloped shelves allow for high visibility, productive rotations and gravity feed. **Cart Finish:** Chrome

Each unit consists of:

- 2 - 34" longer back posts
- 2 - 29" shorter front posts
- 1 - flat wire shelf
- 1 - slanted wire shelf
- 4 - 5" swivel thermoplastic resin casters, 2 with brakes
- 4 - donut bumpers



M1836SL34C
Shown with Bins
(Bins are sold separately)

MOBILE MODEL NO.	SHELF DIMENSIONS W" x L"	NO. OF SHELVES	SHIP WGT
40"H - Work Station Carts			
M1836SL34C	18" x 36"	2	38 lbs
M1848SL34C	18" x 48"	2	48 lbs
M2436SL34C	24" x 36"	2	44 lbs
M2448SL34C	24" x 48"	2	50 lbs



MWRS-5-92060



WRSL6-74-1848-260

NO. OF BINS	BIN DIMENSIONS L" x W" x H"	NO. OF SHELVES	STATIONARY		MOBILE	
			MODEL NO.	SHIP WGT	MODEL NO.	SHIP WGT
18"W x 36"L x 63"H - Wire Shelving System with 2 Flat Shelves and 3 Slanted Shelves Includes Dividable Grid Containers Available in Blue, Gray, Red and Clear						
12 DG92035	16-1/2" x 10-7/8" x 3-1/2"	5	WRS-5-92035	89 lbs	MWRS-5-92035	100 lbs
12 DG92060	16-1/2" x 10-7/8" x 6"	5	WRS-5-92060	96 lbs	MWRS-5-92060	107 lbs
12 DG92080	16-1/2" x 10-7/8" x 8"	5	WRS-5-92080	107 lbs	MWRS-5-92080	118 lbs
18"W x 36"L x 74"H - Wire Shelving System with 2 Flat Shelves and 5 Slanted Shelves Includes Economy Shelf Bins Available in Blue, Green, Ivory, Red, Yellow, Black and Clear						
48 QSB103	17-7/8" x 4-1/8" x 4"	7	WRS-7-103	118 lbs	MWRS-7-103	129 lbs
30 QSB104	17-7/8" x 6-5/8" x 4"	7	WRS-7-104	110 lbs	MWRS-7-104	121 lbs
24 QSB108	17-7/8" x 8-3/8" x 4"	7	WRS-7-108	113 lbs	MWRS-7-108	124 lbs
18 QSB110	17-7/8" x 11-1/8" x 4"	7	WRS-7-110	111 lbs	MWRS-7-110	122 lbs
18"W x 36"L x 74"H - Wire Shelving System with 2 Flat Shelves and 5 Slanted Shelves Includes Euro Drawers Available in Blue, Red, Yellow and Gray						
48 QED604	17-5/8" x 3-3/4" x 4-5/8"	7	WRS-7-604	144 lbs	MWRS-7-604	155 lbs
30 QED602	17-5/8" x 5-9/16" x 4-5/8"	7	WRS-7-602	126 lbs	MWRS-7-602	137 lbs
18 QED606	17-5/8" x 8-3/8" x 4-5/8"	7	WRS-7-606	132 lbs	MWRS-7-606	143 lbs
18"W x 48"L x 74"H - Wire Shelving System with 2 Flat Shelves and 4 Slanted Shelves Includes Ultra Bins Available in Blue, Green, Ivory, Red, Yellow, Black and Clear						
16 QUS260	18" x 11" x 10"	6	WRSL6-74-1848-260	168 lbs	WRCSL6-74-1848-260	179 lbs
24"W x 48"L x 74"H - Wire Shelving System with 2 Flat Shelves and 4 Slanted Shelves Includes Hulk 24" Containers Available in Blue, Red, Yellow and Clear						
16 QUS953	23-7/8" x 11" x 10"	6	WRSL6-74-2448-953	184 lbs	WRCSL6-74-2448-953	195 lbs

Slanted Shelf Carts - Stationary and Mobile

Stationary and Mobile Slanted Shelf units create a unique combination of modular components to enhance supply distribution applications. The sloped shelves allow for high visibility, productive rotations and gravity feed. **(Note: Build a system with your bin requirements or consult a product specialist for appropriate components)**

Each unit consists of:

- 4 - 63" posts
- 2 - flat wire shelves
- 3 - slanted wire shelves

Each mobile unit consists of:

- 4 - 63" posts
- 2 - flat wire shelves
- 3 - slanted wire shelves
- 4 - 5" swivel thermoplastic resin casters, 2 with brakes
- 4 - donut bumpers

63"H - SLANTED SHELF CARTS

SHELF DIMENSIONS W" x L"	NO. OF SHELVES	STATIONARY		MOBILE	
		MODEL NO.	SHIP WGT	MODEL NO.	SHIP WGT
18" x 36"	5	1836SL6C	66 lbs	M1836SL6C	76 lbs
18" x 48"	5	1848SL6C	86 lbs	M1848SL6C	96 lbs
24" x 36"	5	2436SL6C	81 lbs	M2436SL6C	91 lbs
24" x 48"	5	2448SL6C	96 lbs	M2448SL6C	106 lbs

COMPLETE PACKAGES WITH BINS



MWRS-7-104

Up to 1,200 lb.
MOBILE LOAD CAPACITY



Slanted Shelf with Bin Holders Combo Carts

A systems cart that offers hanging bins, slanted bins and bins on a flat surface all in one unit. Carts offer the ability to store pre-packed items or sloped storage for dispensing small parts. This combination creates a highly customized exchange and storage system. **Cart Finish:** Chrome

Bins available in: ● Blue ● Green ● Ivory ● Red ● Yellow
● Black ● Clear (One color per unit)

MODEL NO.	NO. OF SHELVES	NO. OF BINS	BIN DIMENSIONS L" x W" x H"	SHIP WGT
18"W x 36"L x 80"H - Slanted Wire Shelf Cart with Bin Holders and Bins				
WRCSL5-74-1836-104220	5	20 QSB104 24 QUS220	17-7/8" x 6-5/8" x 4" 7-3/8" x 4-1/8" x 3"	105 lbs
WRCSL5-74-1836-104230	5	20 QSB104 18 QUS230	17-7/8" x 6-5/8" x 4" 10-7/8" x 5-1/2" x 5"	112 lbs
18"W x 48"L x 80"H - Slanted Wire Shelf Cart with Bin Holders and Bins				
WRCSL5-74-1848-104220	5	24 QSB104 30 QUS220	17-7/8" x 6-5/8" x 4" 7-3/8" x 4-1/8" x 3"	128 lbs

Slanted Shelf Carts - Open or Enclosed

Units are designed for quick and easy accessibility for pre-packed items. The wire end panel maintains product while the slanted shelf allows for gravity feed. Available with or without side enclosures. **Cart Finish:** Chrome

OPEN		ENCLOSED	
MODEL NO.	SHIP WGT	MODEL NO.	SHIP WGT
5 Shelf - Slanted Cart 2 Flat Shelves and 3 Slanted Shelves			
WRCSL5-63-1836	76 lbs	WRCSL5-63-1836EP	88 lbs
WRCSL5-63-1848	96 lbs	WRCSL5-63-1848EP	108 lbs
WRCSL5-63-2436	91 lbs	WRCSL5-63-2436EP	105 lbs
WRCSL5-63-2448	106 lbs	WRCSL5-63-2448EP	120 lbs

**COMPLETE
PACKAGES
WITH BINS**



**QUANTUM
HAS A NEW ANGLE
FOR STORAGE**



Up to 1,200 lb.
**MOBILE LOAD
CAPACITY**

**Dividers, Bin Cups and
Clear Label Holders**
See pg. 114

Bins available in: ● Blue ● Green ● Ivory ● Red ● Yellow ● Black ● Clear (One color per unit)

		OPEN		ENCLOSED	
NO. OF BINS	BIN DIMENSIONS L" x W" x H"	MODEL NO.	SHIP WGT	MODEL NO.	SHIP WGT
5 Shelf - Slanted Shelf Cart with Bins 2 Flat Shelves and 3 Slanted Shelves					
20 QSB104	17-7/8" x 6-5/8" x 4"	WRCSL5-63-1836-104	94 lbs	WRCSL5-63-1836EP-104	103 lbs
28 QSB104	17-7/8" x 6-5/8" x 4"	WRCSL5-63-1848-104	114 lbs	WRCSL5-63-1848EP-104	123 lbs
20 QSB106	23-5/8" x 6-5/8" x 4"	WRCSL5-63-2436-106	115 lbs	WRCSL5-63-2436EP-106	131 lbs
28 QSB106	23-5/8" x 6-5/8" x 4"	WRCSL5-63-2448-106	136 lbs	WRCSL5-63-2448EP-106	152 lbs



IDEAL STORAGE SOLUTION!

Wine Cradle Wire Shelf

NSF

Quantum's NEW Wine Cradle Shelf is a perfect storage solution for all wine enthusiasts. Shelves comes in two sizes: a 36"L that holds up to 9 bottles and a 48"L that holds up to 12 bottles. **Finishes:** Chrome and Black Epoxy

Up to 12
BOTTLES PER SHELF



1436WSC
1436WSBK
Wine Cradle Wire Shelf
14"W x 36"L

Wine Cradle Cart

NSF

Excellent mobile storage solution for your wine collection. These carts includes two cradle shelves, a wire or stainless steel top shelf and a bottom wire shelf for additional storage. All units include 4 posts, 4 donut bumpers and 4 casters, 2 with brakes.



NEW

WRC-1436WSBK-1SS
Wine Cradle Cart
14"W x 36"L x 45"H

2 cradle shelves. Holds up to 18 bottles.
1 stainless steel top shelf. 1 wire bottom shelf.

Wine Cradle Wire Unit

NSF

The complete storage solution for your location. This practical unit can be used in most indoor and/or outdoor settings. Units come with up to 17 cradle shelves and can holds up to 204 bottles, includes 4 posts, foot plates and wall brackets.

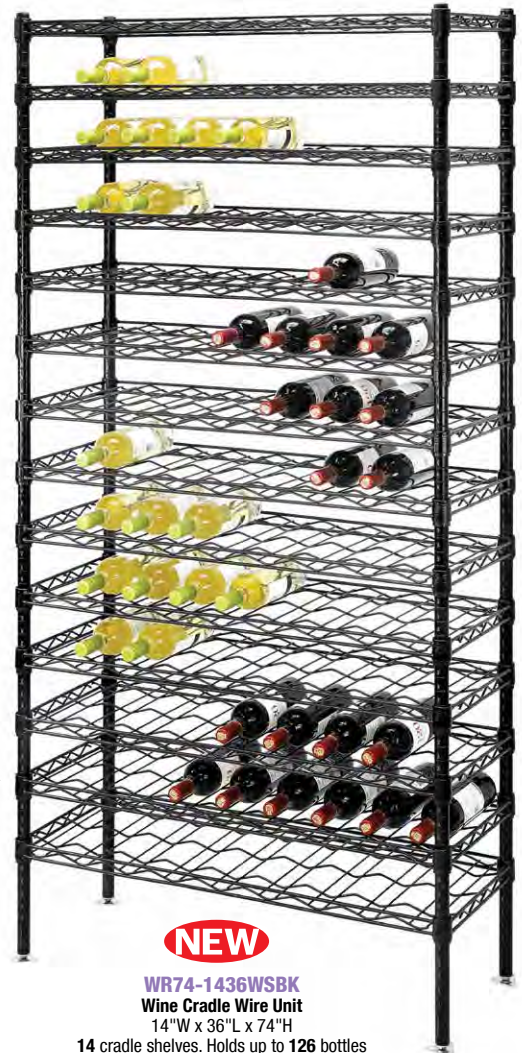

NEW

WR74-1436WSBK
Wine Cradle Wire Unit
14"W x 36"L x 74"H

14 cradle shelves. Holds up to 126 bottles

FINISHES:

- ◆ CHROME C
- ◆ BLACK EPOXY BK

MODEL NO.	DIMENSIONS W" x L" x H"	SHIP WGT
Wine Cradle Wire Shelves		
1436WSC	14" x 36"	7 lbs
1436WSBK	14" x 36"	7 lbs
1448WSC	14" x 48"	9 lbs
1448WSBK	14" x 48"	9 lbs
Wine Cradle Carts		
WRC-1436WSC	14" x 36" x 45"	53 lbs
WRC-1436WSC-1SS	14" x 36" x 45"	58 lbs
WRC-1436WSBK	14" x 36" x 45"	53 lbs
WRC-1436WSBK-1SS	14" x 36" x 45"	58 lbs
Wine Cradle Wire Units		
WR74-1436WSC	14" x 36" x 74"	120 lbs
WR74-1436WSBK	14" x 36" x 74"	120 lbs
WR86-1436WSC	14" x 36" x 86"	145 lbs
WR86-1436WSBK	14" x 36" x 86"	145 lbs
WR74-1448WSC	14" x 48" x 74"	148 lbs
WR74-1448WSBK	14" x 48" x 74"	148 lbs
WR86-1448WSC	14" x 48" x 86"	179 lbs
WR86-1448WSBK	14" x 48" x 86"	179 lbs



PERFORMANCE FEATURES:

- Assembles in minutes
- Wire design allows for air circulation and minimal dust buildup
- Shelves easily adjust on 1" centers to your exact needs
- 1 year limited warranty on Chrome and 15 year limited warranty on Black Epoxy
- Includes posts, shelves, and all needed hardware
- No tools required



Wine Cantilever Systems



Versatile adjustable post wall-mount system, perfect for maximizing storage in challenging areas alongside floor storage. Offered in both single and double configurations, capable of accommodating up to 96 bottles. **Finishes:** Chrome and Black Epoxy

SINGLE MODEL NO.	DIMENSIONS L" x H"	SHIP WGT
14" W Single Wine Cantilever System		
WC14-1436WC	36" x 14"	16 lbs
WC14-1448WC	48" x 14"	19 lbs
WC34-1436WC-2	36" x 34"	31 lbs
WC34-1448WC-2	48" x 34"	36 lbs
WC34-1436WC-3	36" x 34"	42 lbs
WC34-1448WC-3	48" x 34"	52 lbs
WC54-1436WC-4	36" x 54"	60 lbs
WC54-1448WC-4	48" x 54"	70 lbs
14" W Double Wine Cantilever System		
WC14-1436WC-2	72" x 14"	35 lbs
WC14-1448WC-2	96" x 14"	51 lbs
WC34-1436WC-4	72" x 34"	61 lbs
WC34-1448WC-4	96" x 34"	79 lbs
WC34-1436WC-6	72" x 34"	100 lbs
WC34-1448WC-6	96" x 34"	115 lbs
WC54-1436WC-8	72" x 54"	135 lbs
WC54-1448WC-8	96" x 54"	155 lbs



Wine Cradle shelves can be adjusted on a 1" increments.

Wine Bulk Shelving



Allows for storing a substantial wine collection within a confined area. Angles bottles at a 10° incline to preserve cork moisture. The open-wire design facilitates airflow, crucial for temperature regulation. Each unit is enclosed by rear and side panels to ensure bottle security and prevent accidents. **Finishes:** Chrome and Black Epoxy

MODEL NO.	DIMENSIONS W" x L" x H"	SHIP WGT
74" W Wine Bulk Shelving		
WR74-BW1436C	14" x 36" x 74"	140 lbs
WR74-BW1448C	14" x 48" x 74"	170 lbs

FINISHES:

- ◆ CHROME C ◆ BLACK EPOXY BK

REPLACE SUFFIX "C" WITH "BK" IN MODEL NO. TO ORDER BLACK EPOXY FINISH

Ex. WC34-1436WBK-2 WR74-BW1436BK



NEW

WR74-BW1436BK
Wine Bulk Shelving
14"W x 36"L x 74"H



NEW

WC34-1436WBK-4
Wine Cantilever System
72"L x 34"H

QUICK, EASY ASSEMBLY

Wine Wire Security Units



Security units prevent pilferage while allowing high visibility of contents at all times. All side and back panels are heavy gauge wire construction and are manufactured of all-welded heavy-duty 1/4" diameter wire on 2" x 2" centers. Assembly is quick and easy. **Finishes:** Chrome and Black Epoxy

ADD SUFFIX "BK" TO MODEL NO. TO ORDER BLACK EPOXY FINISH

Ex. 1436-74BWSECBK

MODEL NO.	DIMENSIONS W" x L" x H"	SHIP WGT
74" Stationary Bulk		
1436-74BWSEC	14" x 36" x 74"	202 lbs
1448-74BWSEC	14" x 48" x 74"	244 lbs
74" Stationary Mixed		
1436-74MIXSEC	14" x 36" x 74"	210 lbs
1448-74MIXSEC	14" x 48" x 74"	252 lbs
69" Mobile Bulk		
M1436-69BWSEC	14" x 36" x 69"	205 lbs
M1448-69BWSEC	14" x 48" x 69"	246 lbs
69" Mobile Mixed		
M1436-69MIXSEC	14" x 36" x 69"	213 lbs
M1448-69MIXSEC	14" x 48" x 69"	254 lbs



NEW

M1436-69MIXSEC
Wine Wire Security Cart
14"W x 36"L x 69"H

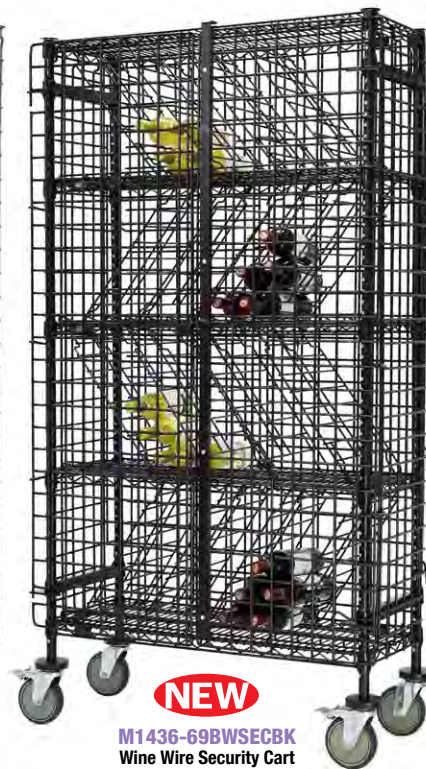

NEW

M1436-69BWSECBK
Wine Wire Security Cart
14"W x 36"L x 69"H



Stationary and Mobile Wire Garment Racks

Ideal storage rack for hanging any type of coat or garment. Includes handy bottom shelf for additional storage.

Finish: Chrome

Each unit consists of:

- 4 - 63" posts
- 2 - wire shelves
- 1 - hang bar (Up to 75 lb. hang capacity evenly distributed)

Mobile unit also includes:

- 4 - 5" swivel thermoplastic resin casters, 2 with brakes
- 4 - donut bumpers

MODEL NO.	DIMENSIONS W" x L" x H"	NO. OF SHELVES	SHIP WGT
Stationary Wire Garment Racks			
WRGR-63-2436	24" x 36" x 63"	2	45 lbs
WRGR-63-2448	24" x 48" x 63"	2	52 lbs
WRGR-63-2460	24" x 60" x 63"	2	63 lbs
Mobile Wire Garment Racks			
WRCGR-63-2436	24" x 36" x 69"	2	59 lbs
WRCGR-63-2448	24" x 48" x 69"	2	66 lbs
WRCGR-63-2460	24" x 60" x 69"	2	77 lbs



WRCGR-63-2436



RACK AND CART COVERS
Protect against pilferage, airborne dust, moisture and other contaminants.

NYLON FABRIC OR CLEAR VINYL RACK AND CART COVERS AVAILABLE

See pg. 46

CARTS INCLUDE CASTER KIT FOR MOBILITY

Up to 1,200 lb. MOBILE LOAD CAPACITY

Apparel Cart

Ideal for patient care situations where the distribution and holding of apparel is required. The horizontal bar accommodates hangers and the shelves are divided into separate visible compartments.

Finish: Chrome

Unit consists of:

- 4 - 63" posts
- 2 - 54" posts
- 2 - 24"W x 60"L wire shelves
- 3 - 24"W x 36"L wire shelves
- 8 - 24" dividers
- 2 - 61" rods and tabs kits
- 1 - 24" hang bar (Up to 75 lb. hang capacity evenly distributed)
- 4 - 5" swivel thermoplastic resin casters, 2 with brakes
- 4 - donut bumpers

MODEL NO.	DIMENSIONS W" x L" x H"	NO. OF SHELVES	SHIP WGT
WRCPL-63-2460	24" x 60" x 69"	5	146 lbs



WRCPL-63-2460



Mobile To Go



This Mobile To Go station comes with five shelves and offers a black epoxy finish, which helps packages stand out, making them easier to spot. Eliminate congestion around counter spaces by reducing traffic around the register so that customers and delivery drivers may easily pick up their orders in a convenient location. Use the label holders on each shelf to arrange and alphabetize the orders. Adjustable shelves enhance order visibility, accessibility, and security. This station has a pick up sign to draw customers and delivery people's attention and give them the convenient pick up experience.

MODEL NO.	DIMENSIONS W" x L" x H"	SHIP WGT
QTG63-1824BK	18" x 24" x 63"	63 lbs
QTG63-1836BK	18" x 36" x 63"	82 lbs
QTG63-1848BK	18" x 48" x 63"	108 lbs
QTG63-1860BK	18" x 60" x 63"	124 lbs

Up to **600-800 lb.**
LOAD CAPACITY PER SHELF



1836SM

Note: Sign does require additional time for shipping



- Each unit consists of:
- 2 - 63" posts
 - 2 - 54" posts
 - 5 - wire shelves
 - 5 - shelf inlay mats
 - 1 - hang rail
 - 5 - 3" label holders
 - 1 - sign

QTG63-1836BK
Black Epoxy Finish

Mobile Ingredient Organizer



Ideal for combining work station and storage on the go.

Bins available in: Blue Green Ivory Red Yellow Black Clear

MODEL NO.	DIMENSIONS W" x L" x H"	NO. OF BINS	SHIP WGT
WRC-CC1430GY	14" x 30" x 33"	12	64 lbs
WRC-CC1436GY	14" x 36" x 33"	18	76 lbs
WRC-CC1830GY	18" x 30" x 33"	12	69 lbs
WRC-CC1836GY	18" x 36" x 33"	18	80 lbs

(One color per unit)

Each unit consists of:

- 4 - 27" cut posts
- 1 - wire shelf
- 1 - solid stainless shelf
- 3 - bin rail holders
- 4 - donut bumpers
- 4 - 5" thermoplastic resin casters, 2 with brakes

(Quantity of QUS230 bins listed in chart above)



WRC-CC1436GYGN
Bins sold separately see pg. 93

Countertop Ingredient Organizer



Ideal for serving areas and lunch rooms, minimizing clutter on the counter.

Bins available in: Blue Green Ivory Red Yellow Black Clear

MODEL NO.	DIMENSIONS W" x L" x H"	NO. OF BINS/DIVIDERS	SHIP WGT
CT27-1824GY-230	18" x 24" x 27"	12	40 lbs
CT27-1830GY-230	18" x 30" x 27"	16	53 lbs
CT27-1836GY-230	18" x 36" x 27"	24	59 lbs

(One color per unit)

Each unit consists of:

- 2 - 27" cut posts
 - 2 - 6" posts
 - 1 - 3 sided frame
 - 4 - bin rail holders
- (Quantity of QUS230 bins and dividers listed in chart above)



CT27-1830GY-230BL



Pizza Dough Boxes



Quantum's Pizza Dough Boxes are built to perfect the proofing process. Made from heavy-duty polypropylene, these boxes are lightweight, durable, and break resistant.

- Freezer and Microwaveable safe
- Bulk, no carton packaging available at discount prices, call for details



FSB-PT26183
Shown with LID **FSB-PL2618**



FSB-DL1813
"ARTISAN LID"



FSB-DT18133
"ARTISAN DOUGH TRAY"



FSB-PL2618



FSB-PT26183



FSB-PT26186

**IDEAL FOR STORING,
PROOFING, TRANSPORTING
AND COOLING PIZZA DOUGH**

Up to 800 lb.
MOBILE LOAD CAPACITY

**2 COLORS AVAILABLE
WHITE & GRAY**

Unit consists of:

- 6 - Artisan Dough Box Lid - **FSB-DL1813**
- 6 - Artisan Dough Box Tray - **FSB-DT18133**
- 6 - Pizza Dough Box - **FSB-PL2618**
- 6 - Pizza Dough Box Lid - **PT26183**
- 1 - Dolly - **FSB-PTDLY**



FSB-PTDLY

25-5/8" L X 18" W X 7" H
Includes four 5" x 1-1/4" poly casters, two rigid, two swivel, one with brake. Available in Black.



FSB-MD3LP3L

**ADD SUFFIX TO END OF EACH MODEL NO.
WHEN SELECTING COLOR**

◆ WHITE WT ◆ GRAY GY

Precision engineering and design ensures a space-efficient and secure stacked configuration to reduce the need for extra lids, while keeping ideal moisture and temperature for the yeast to grow. The boxes withstand temperatures ranging from -40°F to 160°F. **Colors:** White and Gray. Custom colors are also available, please call for details.

MODEL NO.	OUTSIDE DIMENSIONS L" x W" x H"	INSIDE DIMENSIONS L" x W" x H"	CAPACITY (CU FT)	CTN QTY	CTN WGT
FSB-PT26183	25-5/8" x 18" x 3-3/8"	23-7/8" x 16" x 3"	0.66	6	25 lbs
FSB-PT26186	25-5/8" x 18" x 6-3/8"	23-7/8" x 16" x 6"	1.33	6	31 lbs
FSB-PL2618	25-5/8" x 18" x 1-3/4"	23-7/8" x 16" x 1"	0.22	6	16 lbs
FSB-DT18133	17-3/4" x 12-3/4" x 3-3/8"	15-7/8" x 11-1/8" x 3"	0.31	6	11 lbs
FSB-DL1813	17-3/4" x 12-3/4" x 3/4"	15-7/8" x 11-1/8" x 3/4"	0.08	6	6 lbs

To order a full case add **CS** suffix to Model No. **FSB-PT26183GYCS**





Cross Stack Tubs



Manufactured from approved USDA/FDA materials, totes nest when empty or can be turned 90° to cross stack. Easy access to items when stacked. Injection molded from durable, high impact polypropylene. Easy to clean. Built in handle grips and bottom grooves makes handling easy. Holds up to 100 lbs. per bin 1/4" drill hole pattern on bottom of bin allows for easy hole insertion for optional drainage and air flow.

Available in: ● Blue ● Gray ○ White **TUB2516-8/LID2516-8** also available in: ● Red ● Yellow

MODEL NO.	OUTSIDE DIMENSIONS L" x W" x H"	INSIDE BOTTOM DIMENSIONS L" x W"	CAP GAL	CTN QTY	CTN WGT	LID	CTN QTY
TUB1711-8	17-1/4" x 11" x 8"	13" x 7-1/2"	3.85	6	14 lbs	LID1711	6
TUB1711-12	17-1/4" x 11" x 12"	12-5/8" x 7"	5.51	6	17 lbs	LID1711	6
TUB2417-8	23-3/4" x 17-1/4" x 8"	19-5/8" x 13-3/4"	9.81	6	25 lbs	LID2417	6
TUB2417-12	23-3/4" x 17-1/4" x 12"	18-7/8" x 13-1/4"	14.38	6	30 lbs	LID2417	6
TUB2516-8	25-1/8" x 16" x 8-1/2"	20-1/2" x 13-3/8"	9.75	6	20 lbs	LID2516-8	6
SNH010	Six Clear Label Holders - 3" x 5"			6	1 lb	-	-

To order a full carton add **CS** suffix to Model No. TUB1711-8BLCS. **Note:** Bins must be ordered in carton quantities only.

5 SIZES AND 5 COLORS AVAILABLE



TUB2516-8
Nesting and Cross Stack

Tub Racks - Complete Packages



All-welded aluminum Tub Rack transports and stores all types of product. Cart comes with four swivel 5" x 1" Polyolefin casters. Runners allow bins to slide in and out from both sides. Rack comes complete with tubs.

Tubs available in: ● Blue ● Gray ○ White ● Red ● Yellow

MODEL NO.	DIMENSIONS L" x W" x H"	NO. OF BINS	SHIP WGT
Tub Rack with Cross Stack Tubs Tub Dimensions 25-1/8"L x 16"W x 8-1/2"H			
TR1-2516-8	27" x 19" x 19"	1	13 lbs
TR2-2516-8	27" x 19" x 31"	2	25 lbs
TR3-2516-8	27" x 19" x 41"	3	33 lbs
TR4-2516-8	27" x 19" x 51"	4	46 lbs
TR5-2516-8	27" x 19" x 61"	5	54 lbs
TR6-2516-8	27" x 19" x 71"	6	58 lbs
TR12-2516-8	27" x 37" x 71"	12	114 lbs



TR1-2516-8
Comes with 1 TUB2516-8

TR2-2516-8
Comes with 2 TUB2516-8

TR3-2516-8
Comes with 3 TUB2516-8

QuanTub Nesting Tote



Manufactured of approved USDA/FDA materials, this tote is ideal in food service and storage and general product handling. Strong and durable tote is injection molded from high-density polypropylene. Each tote can hold up to 100 lbs. Tote is easy to clean. Rolled top rim for comfortable grip. Rounded corners add strength to stress points. Totes nest when empty and prevent jamming with rib top. 1/4" drill hole pattern on bottom of bin allows for easy hole insertion for optional air flow and drainage.

Available in: ● Blue ● Gray

MODEL NO.	OUTSIDE DIMENSIONS L" x W" x H"	INSIDE BOTTOM DIMENSIONS A" x B"	CAP GAL	CTN QTY	CTN WGT
TUB2419-9	24-1/2" x 19" x 9-1/2"	20-1/4" x 15-1/4"	14.6	6	33 lbs

To order a full carton add **CS** suffix to Model No. TUB2419-9GYCS. **Note:** Bins must be ordered in carton quantities only.



TUB2419-9

Polymer Dolly

DLY-3018 is 30"L x 18"W with padded rubber trim, available in Blue. Set of four 4" x 1-1/4" non-marking swivel poly casters. Up to 1,000 lb. load capacity.

MODEL NO.	DESCRIPTION	CTN WGT
DLY-3018	Dolly with Padded Rubber Trim	19 lbs
HANDLE-DLY	32" Dolly Pull Rod with Handle	2 lbs



ATTACHED PULL RING
allows dolly to be pulled with ease



HANDLE-DLY
Dolly Pull Rod



Modular Trays



Heavy-duty 18" x 26" white trays are NSF approved and can be used in any application. Perimeter ends are reinforced for additional strength. 20" x 26" size offers a deep stacking tray. All trays are manufactured from fiberglass reinforced thermoset material, allowing up to 200 lb. weight capacity when evenly distributed. Quantum's modular trays will withstand temperatures of -40°F to +350°F. 18" x 26" Trays available in White and Black, 20" x 26" Trays are available in Gray, White and Black.

Available in: ● Gray ○ White ● Black

MODEL NO.	DIMENSIONS W" x L" x H"	SHIP WGT
18" x 26" - Trays		
1826TR	18" x 26" x 1-1/8" White Tray	4 lbs
1826ESD	18" x 26" x 1-1/8" Black Tray	4 lbs
20" x 26" - Stackable Trays		
2026TRGY	20" x 26" x 1-1/2" Gray Tray	5 lbs
2026TRWT	20" x 26" x 1-1/2" White Tray	5 lbs
2026ESD	20" x 26" x 1-1/2" Black Tray	5 lbs



1826TR



1826ESD



2026TRGY
Stackable Tray

Up to 200 lb.
LOAD CAPACITY PER TRAY

Modular Tray Carts

Tray Carts are offered in half size and full size units, designed to handle work in process. Optional Tray Stop prevents trays from falling out. **Cart Finish:** Chrome

MODEL NO.	DIMENSIONS W" x L" x H"	SHIP NO. OF TRAY WGT TRAYS	TRAY STOP MODEL NO.
39"H - Side Load Tray Cart			
TC-19	18" x 30" x 39"	45 lbs 19	1826ESD 1826TR TS32C
69"H - Side Load Tray Carts			
TC-20	18" x 30" x 69"	72 lbs 20	1826ESD 1826TR TS32C
TC-39	18" x 30" x 69"	74 lbs 39	1826ESD 1826TR TS62C
TC-31	21" x 30" x 69"	68 lbs 31	2026ESD 2026TR TS62C
69"H - End Load Tray Cart			
TC-EL38	21-3/4" x 27" x 69"	74 lbs 38	1826ESD 1826TR TS62C

Trays are sold separately



TC-19 + 1826TR
(Trays sold separately)



TC-EL38 + 1826TR
End Load Cart
(Trays sold separately)



TC-39 + 1826ESD
Side Load Cart
Tray Stops can be used on back as shown here or one in the back and one in the front.
(Trays sold separately)

Tray Slides



Efficiently utilize space between shelves using standard trays and/or bins.

- Available in 18" and 24" depths, overall height 23"
- Accommodates up to 10 trays

MODEL NO.	DESCRIPTION	SHIP WGT
Tray Slide		
TS18C	18" Tray Slide Set	10 lbs
TS24C	24" Tray Slide Set	11 lbs



TS62C
Tray Stop
(Optional)



Bussing Tubs and Utility Boxes



Quantum's heavy-duty bussing tubs and utility boxes are built to last! Available in Polypropylene, these containers are engineered for rigorous and continuous usage. ABS, HDPE and custom colors are also available, please call for details. All tubs are super easy to clean and dishwasher safe. Virgin grade materials afford lifetime protection against bacteria, mold, mildew, and product degradation. Antimicrobial material additives available as well. **Colors:** Black, Brown or Gray

4 COLORS AVAILABLE



FSB-21155



FSB-21155R
(Ribbed bottom)



FSB-22175



FSB-22177R
"AIRPORT STYLE"
(Ribbed bottom) Also available in Blue(BL)



FSB-L2216
**Lid for FSB-20155R*
Also available in Blue(BL)



FSB-1295



FSB-1544



FSB-20113



FSB-21165



FSB-20155



FSB-20155R
"AIRPORT STYLE"
(Ribbed bottom) Also available in Blue(BL)



FSB-21157



FSB-21157R
(Ribbed bottom)

All-purpose tubs provide a storage, cleaning, and transportation solution for multiple applications. Built in handles are ergonomically designed for comfortable and easy-grip and handling. All tubs nest when empty saving valuable workspace.

ADD SUFFIX TO END OF EACH MODEL NO. WHEN SELECTING COLOR
 • GRAY GY • BROWN BN • BLACK BK • BLUE BL **Ex. FSB-20155BK**

NEST WHEN EMPTY TO SAVE SPACE

- Bulk, no carton packaging available at discount prices, call for details

MODEL NO.	OUTSIDE DIMENSIONS L" x W" x H"	INSIDE DIMENSIONS L" x W" x H"	CAPACITY (CU FT)	CTN QTY	CTN WGT	LID MODEL NO.
FSB-1295	12-1/16" x 9-1/16" x 5-1/8"	11-1/4" x 8-1/4" x 5"	0.325	12	11 lbs	-
FSB-1544	14-3/16" x 4-7/16" x 4-1/8"	13-1/2" x 16" x 4"	0.150	12	5 lbs	-
FSB-20113	20-7/16" x 11-3/8" x 3-3/4"	19-7/8" x 16" x 3-5/8"	0.496	12	20 lbs	-
FSB-20155	20" x 15" x 5"	19-1/4" x 14-1/4" x 4-7/8"	0.868	12	20 lbs	FSB-L2016
FSB-20155R	20" x 15" x 5"	19-1/4" x 14-1/4" x 4-7/8"	0.868	12	19 lbs	FSB-L2216
FSB-21155	21" x 15" x 5"	20-1/4" x 14-1/4" x 4-7/8"	0.911	12	24 lbs	FSB-L2115
FSB-21155R	21" x 15" x 5"	20-1/4" x 14-1/4" x 4-7/8"	0.911	12	26 lbs	FSB-L2115R
FSB-21157	21" x 15" x 7"	20-1/4" x 14-1/4" x 6-7/8"	1.276	12	26 lbs	FSB-L2115
FSB-21157R	21" x 15" x 7"	20-1/4" x 14-1/4" x 6-7/8"	1.276	12	27 lbs	FSB-L2115R
FSB-21165	20" x 15" x 5"	19-1/2" x 14-1/4" x 4-7/8"	0.868	12	32 lbs	-
FSB-22175	22" x 17" x 5"	21-1/4" x 16-1/4" x 4-7/8"	1.082	12	27 lbs	FSB-L2217
FSB-22177R	21-1/2" x 17" x 7"	21-1/4" x 16-1/4" x 6-7/8"	1.057	12	32 lbs	-

To order a full carton add **CS** suffix to Model No. FSB-20155BKCS. Note: Bins must be ordered in carton quantities only.

SUPER EASY TO CLEAN





Open Utility Carts

Corrosion-free open utility carts helps transport and deliver multiple food products from storage to aisles with easy. **Finish:** Stainless Steel

3 Sided Frames



STAINLESS MODEL NO.	DIMENSIONS W" x L"	SHIP WGT
2436FS	24" x 36"	8 lbs
2448FS	24" x 48"	9 lbs
2460FS	24" x 60"	10 lbs

CARTS INCLUDE CASTER KIT FOR MOBILITY



WRSC3-42-2436FS
24"W x 36"L x 48"H

MODEL NO.	DIMENSIONS W" x L" x H"	NO. OF SHELVES	SHIP WGT
48" Polymer Flat Top Shelf Cart			
WRSC3-42-2436FS	24" x 36" x 48"	3	77 lbs
WRSC3-42-2448FS	24" x 48" x 48"	3	88 lbs
WRSC3-42-2460FS	24" x 60" x 48"	3	106 lbs
60" Polymer Flat Top Shelf Cart			
WRSC4-54-2436FS	24" x 36" x 60"	4	94 lbs
WRSC4-54-2448FS	24" x 48" x 60"	4	108 lbs
WRSC4-54-2460FS	24" x 60" x 60"	4	131 lbs

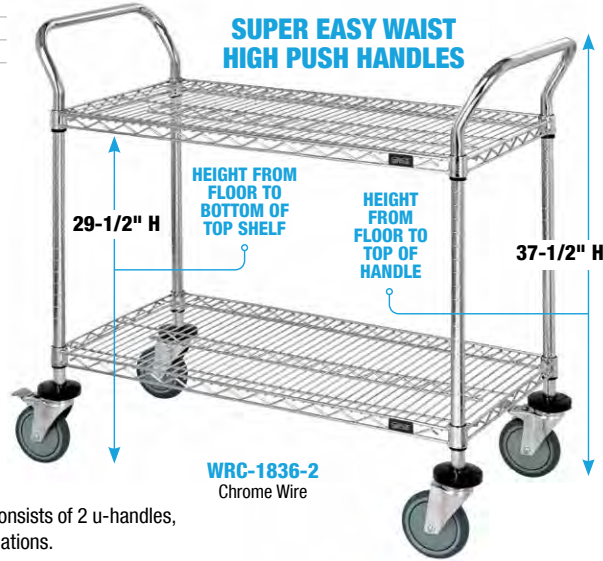

SUPER EASY WAIST HIGH PUSH HANDLES

29-1/2" H
HEIGHT FROM FLOOR TO BOTTOM OF TOP SHELF

37-1/2" H
HEIGHT FROM FLOOR TO TOP OF HANDLE



Black Epoxy Wire



Solid Stainless Steel

WRC-1836-2
Chrome Wire

Up to 1,200 lb.
MOBILE LOAD CAPACITY

UTILITY CARTS IN ANY STYLE, FINISH, OR CONFIGURATION

Wire Utility Carts

Give versatility to any operation: food service, hospitals and maintenance. Carts consists of 2 u-handles, 4 donut bumpers, 4 swivel casters (2 with brakes) and wire or solid shelf combinations.

DIMENSIONS W" x L" x H"	WIRE SHELF						WIRE & SOLID SHELF			SOLID SHELF		
	CHROME MODEL NO.	STAINLESS MODEL NO.	PROFORM GREEN EPOXY MODEL NO.	GRAY EPOXY MODEL NO.	BLACK EPOXY MODEL NO.	SHIP WGT	CHROME MODEL NO.	STAINLESS MODEL NO.	SHIP WGT	GALVANIZED MODEL NO.	STAINLESS MODEL NO.	SHIP WGT
2 Wire Shelf Utility Cart												
18" x 30" x 37-1/2"	WRC-1830-2	WRSC-1830-2	WRC-1830P-2	WRC-1830GY-2	WRC-1830BK-2	34 lbs	WRC-1830-2CG	WRSC-1830SS-2S	40 lbs	WRC-1830-2G	WRSC-1830-2SS	48 lbs
18" x 36" x 37-1/2"	WRC-1836-2	WRSC-1836-2	WRC-1836P-2	WRC-1836GY-2	WRC-1836BK-2	38 lbs	WRC-1836-2CG	WRSC-1836SS-2S	44 lbs	WRC-1836-2G	WRSC-1836-2SS	50 lbs
18" x 42" x 37-1/2"	WRC-1842-2	WRSC-1842-2	WRC-1842P-2	WRC-1842GY-2	WRC-1842BK-2	40 lbs	WRC-1842-2CG	WRSC-1842SS-2S	47 lbs	WRC-1842-2G	WRSC-1842-2SS	54 lbs
18" x 48" x 37-1/2"	WRC-1848-2	WRSC-1848-2	WRC-1848P-2	WRC-1848GY-2	WRC-1848BK-2	46 lbs	WRC-1848-2CG	WRSC-1848SS-2S	52 lbs	WRC-1848-2G	WRSC-1848-2SS	58 lbs
18" x 60" x 37-1/2"	WRC-1860-2	WRSC-1860-2	WRC-1860P-2	WRC-1860GY-2	WRC-1860BK-2	52 lbs	WRC-1860-2CG	WRSC-1860SS-2S	59 lbs	WRC-1860-2G	WRSC-1860-2SS	68 lbs
21" x 30" x 37-1/2"	WRC-2130-2	WRSC-2130-2	WRC-2130P-2	WRC-2130GY-2	-	38 lbs	WRC-2130-2CG	WRSC-2130SS-2S	44 lbs	WRC-2130-2G	WRSC-2130-2SS	52 lbs
21" x 36" x 37-1/2"	WRC-2136-2	WRSC-2136-2	WRC-2136P-2	WRC-2136GY-2	-	42 lbs	WRC-2136-2CG	WRSC-2136SS-2S	49 lbs	WRC-2136-2G	WRSC-2136-2SS	58 lbs
21" x 42" x 37-1/2"	WRC-2142-2	WRSC-2142-2	WRC-2142P-2	WRC-2142GY-2	-	44 lbs	WRC-2142-2CG	WRSC-2142SS-2S	53 lbs	WRC-2142-2G	WRSC-2142-2SS	64 lbs
21" x 48" x 37-1/2"	WRC-2148-2	WRSC-2148-2	WRC-2148P-2	WRC-2148GY-2	-	48 lbs	WRC-2148-2CG	WRSC-2148SS-2S	57 lbs	WRC-2148-2G	WRSC-2148-2SS	68 lbs
21" x 60" x 37-1/2"	WRC-2160-2	WRSC-2160-2	WRC-2160P-2	WRC-2160GY-2	-	56 lbs	WRC-2160-2CG	WRSC-2160SS-2S	66 lbs	WRC-2160-2G	WRSC-2160-2SS	78 lbs
24" x 30" x 37-1/2"	WRC-2430-2	WRSC-2430-2	WRC-2430P-2	WRC-2430GY-2	WRC-2430BK-2	42 lbs	WRC-2430-2CG	WRSC-2430SS-2S	48 lbs	WRC-2430-2G	WRSC-2430-2SS	56 lbs
24" x 36" x 37-1/2"	WRC-2436-2	WRSC-2436-2	WRC-2436P-2	WRC-2436GY-2	WRC-2436BK-2	46 lbs	WRC-2436-2CG	WRSC-2436SS-2S	52 lbs	WRC-2436-2G	WRSC-2436-2SS	60 lbs
24" x 42" x 37-1/2"	WRC-2442-2	WRSC-2442-2	WRC-2442P-2	WRC-2442GY-2	WRC-2442BK-2	50 lbs	WRC-2442-2CG	WRSC-2442SS-2S	57 lbs	WRC-2442-2G	WRSC-2442-2SS	66 lbs
24" x 48" x 37-1/2"	WRC-2448-2	WRSC-2448-2	WRC-2448P-2	WRC-2448GY-2	WRC-2448BK-2	52 lbs	WRC-2448-2CG	WRSC-2448SS-2S	60 lbs	WRC-2448-2G	WRSC-2448-2SS	68 lbs
24" x 60" x 37-1/2"	WRC-2460-2	WRSC-2460-2	WRC-2460P-2	WRC-2460GY-2	WRC-2460BK-2	62 lbs	WRC-2460-2CG	WRSC-2460SS-2S	72 lbs	WRC-2460-2G	WRSC-2460-2SS	84 lbs
3 Wire Shelf Utility Cart												
18" x 30" x 37-1/2"	WRC-1830-3	WRSC-1830-3	WRC-1830P-3	WRC-1830GY-3	WRC-1830BK-3	42 lbs	WRC-1830-3CG	WRSC-1830SS-3S	48 lbs	WRC-1830-3G	WRSC-1830-3SS	62 lbs
18" x 36" x 37-1/2"	WRC-1836-3	WRSC-1836-3	WRC-1836P-3	WRC-1836GY-3	WRC-1836BK-3	48 lbs	WRC-1836-3CG	WRSC-1836SS-3S	54 lbs	WRC-1836-3G	WRSC-1836-3SS	66 lbs
18" x 42" x 37-1/2"	WRC-1842-3	WRSC-1842-3	WRC-1842P-3	WRC-1842GY-3	WRC-1842BK-3	51 lbs	WRC-1842-3CG	WRSC-1842SS-3S	58 lbs	WRC-1842-3G	WRSC-1842-3SS	72 lbs
18" x 48" x 37-1/2"	WRC-1848-3	WRSC-1848-3	WRC-1848P-3	WRC-1848GY-3	WRC-1848BK-3	60 lbs	WRC-1848-3CG	WRSC-1848SS-3S	66 lbs	WRC-1848-3G	WRSC-1848-3SS	78 lbs
18" x 60" x 37-1/2"	WRC-1860-3	WRSC-1860-3	WRC-1860P-3	WRC-1860GY-3	WRC-1860BK-3	69 lbs	WRC-1860-3CG	WRSC-1860SS-3S	76 lbs	WRC-1860-3G	WRSC-1860-3SS	92 lbs
21" x 30" x 37-1/2"	WRC-2130-3	WRSC-2130-3	WRC-2130P-3	WRC-2130GY-3	-	47 lbs	WRC-2130-3CG	WRSC-2130SS-3S	53 lbs	WRC-2130-3G	WRSC-2130-3SS	67 lbs
21" x 36" x 37-1/2"	WRC-2136-3	WRSC-2136-3	WRC-2136P-3	WRC-2136GY-3	-	53 lbs	WRC-2136-3CG	WRSC-2136SS-3S	60 lbs	WRC-2136-3G	WRSC-2136-3SS	76 lbs
21" x 42" x 37-1/2"	WRC-2142-3	WRSC-2142-3	WRC-2142P-3	WRC-2142GY-3	-	56 lbs	WRC-2142-3CG	WRSC-2142SS-3S	65 lbs	WRC-2142-3G	WRSC-2142-3SS	85 lbs
21" x 48" x 37-1/2"	WRC-2148-3	WRSC-2148-3	WRC-2148P-3	WRC-2148GY-3	-	62 lbs	WRC-2148-3CG	WRSC-2148SS-3S	71 lbs	WRC-2148-3G	WRSC-2148-3SS	91 lbs
21" x 60" x 37-1/2"	WRC-2160-3	WRSC-2160-3	WRC-2160P-3	WRC-2160GY-3	-	74 lbs	WRC-2160-3CG	WRSC-2160SS-3S	84 lbs	WRC-2160-3G	WRSC-2160-3SS	106 lbs
24" x 30" x 37-1/2"	WRC-2430-3	WRSC-2430-3	WRC-2430P-3	WRC-2430GY-3	WRC-2430BK-3	53 lbs	WRC-2430-3CG	WRSC-2430SS-3S	59 lbs	WRC-2430-3G	WRSC-2430-3SS	73 lbs
24" x 36" x 37-1/2"	WRC-2436-3	WRSC-2436-3	WRC-2436P-3	WRC-2436GY-3	WRC-2436BK-3	59 lbs	WRC-2436-3CG	WRSC-2436SS-3S	65 lbs	WRC-2436-3G	WRSC-2436-3SS	79 lbs
24" x 42" x 37-1/2"	WRC-2442-3	WRSC-2442-3	WRC-2442P-3	WRC-2442GY-3	WRC-2442BK-3	65 lbs	WRC-2442-3CG	WRSC-2442SS-3S	72 lbs	WRC-2442-3G	WRSC-2442-3SS	88 lbs
24" x 48" x 37-1/2"	WRC-2448-3	WRSC-2448-3	WRC-2448P-3	WRC-2448GY-3	WRC-2448BK-3	68 lbs	WRC-2448-3CG	WRSC-2448SS-3S	76 lbs	WRC-2448-3G	WRSC-2448-3SS	92 lbs
24" x 60" x 37-1/2"	WRC-2460-3	WRSC-2460-3	WRC-2460P-3	WRC-2460GY-3	WRC-2460BK-3	83 lbs	WRC-2460-3CG	WRSC-2460SS-3S	93 lbs	WRC-2460-3G	WRSC-2460-3SS	115 lbs



Polymer Utility Carts

**RUGGED, HEAVY-DUTY,
DURABLE**

Industrial strength cart is ideal for many industrial and commercial material handling applications. Set of 2 swivel and 2 rigid 5" x 1-1/4" heavy-duty casters allow for up to 550 lb. load capacity. Available in two sizes with a 2 or 3 shelf combination.

Available in: ● Gray

MODEL NO.	OUTSIDE DIMENSIONS L" x W" x H"	INSIDE SHELF DIMENSIONS L" x W" x H"	NO. OF SHELVES	SHIP WGT
PC3518-33	34-1/4" x 17-1/2" x 32-1/2"	29-1/4" x 15-1/4" x 2-5/8"	2	38 lbs
PC3518-33-3	34-1/4" x 17-1/2" x 32-1/2"	29-1/4" x 15-1/4" x 2-5/8"	3	51 lbs
PC4026-33	40" x 26" x 32-1/2"	35" x 23" x 2-5/8"	2	54 lbs
PC4026-33-3	40" x 26" x 32-1/2"	35" x 23" x 2-5/8"	3	74 lbs
Polymer Flat Top Shelf Cart				
PFTC4026-33-2	40" x 26" x 32-1/2"	35" x 23"	2	51 lbs
PFTC4026-33-3	40" x 26" x 32-1/2"	35" x 23"	3	71 lbs
Additional Shelves				
PC3518SHELF	34-1/4" x 17-1/2" x 4-3/16"	29-1/4" x 15-1/4" x 2-5/8"	1	13 lbs
PC4026SHELF	40" x 26" x 4-3/16"	35" x 23" x 2-5/8"	1	20 lbs
Replacement Casters				
PC-CAS-SW	One Replacement Swivel Caster			2 lbs
PC-CAS-RG	One Replacement Rigid Caster			2 lbs

*Inside dimension for middle and bottom shelf 35" x 23" x 2-5/8"

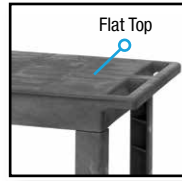

19" H



PC4026-33

**CARTS OFFER
Up to 550 lb.
LOAD CAPACITY**

**Up to 1,200 lb.
MOBILE LOAD CAPACITY**

**UTILITY CARTS
IN ANY STYLE, FINISH,
OR CONFIGURATION**

Push Handle Wire Utility Carts

Give versatility to any operation: food service, hospitals and maintenance. Carts consists of 1 push handle, 4 donut bumpers, 4 swivel casters (2 with brakes) and wire or solid shelf combinations.



WRCP-1836BK-3

DIMENSIONS W" x L" x H"	WIRE SHELF						WIRE & SOLID SHELF			SOLID SHELF		
	CHROME MODEL NO.	STAINLESS MODEL NO.	PROFORM GREEN EPOXY MODEL NO.	GRAY EPOXY MODEL NO.	BLACK EPOXY MODEL NO.	SHIP WGT	CHROME MODEL NO.	STAINLESS MODEL NO.	SHIP WGT	GALVANIZED MODEL NO.	STAINLESS MODEL NO.	SHIP WGT
2 Wire Shelf Push Handle Utility Cart												
18" x 30" x 40"	WRCP-1830-2	WRSCP-1830-2	WRCP-1830P-2	WRCP-1830GY-2	WRCP-1830BK-2	40 lbs	WRCP-1830-2CG	WRSCP-1830SS-2S	46 lbs	WRCP-1830-2G	WRSCP-1830-2SS	52 lbs
18" x 36" x 40"	WRCP-1836-2	WRSCP-1836-2	WRCP-1836P-2	WRCP-1836GY-2	WRCP-1836BK-2	44 lbs	WRCP-1836-2CG	WRSCP-1836SS-2S	50 lbs	WRCP-1836-2G	WRSCP-1836-2SS	56 lbs
18" x 42" x 40"	WRCP-1842-2	WRSCP-1842-2	WRCP-1842P-2	WRCP-1842GY-2	WRCP-1842BK-2	46 lbs	WRCP-1842-2CG	WRSCP-1842SS-2S	53 lbs	WRCP-1842-2G	WRSCP-1842-2SS	60 lbs
18" x 48" x 40"	WRCP-1848-2	WRSCP-1848-2	WRCP-1848P-2	WRCP-1848GY-2	WRCP-1848BK-2	52 lbs	WRCP-1848-2CG	WRSCP-1848SS-2S	58 lbs	WRCP-1848-2G	WRSCP-1848-2SS	64 lbs
18" x 60" x 40"	WRCP-1860-2	WRSCP-1860-2	WRCP-1860P-2	WRCP-1860GY-2	WRCP-1860BK-2	58 lbs	WRCP-1860-2CG	WRSCP-1860SS-2S	65 lbs	WRCP-1860-2G	WRSCP-1860-2SS	72 lbs
21" x 30" x 40"	WRCP-2130-2	WRSCP-2130-2	WRCP-2130P-2	WRCP-2130GY-2	-	43 lbs	WRCP-2130-2CG	WRSCP-2130SS-2S	49 lbs	WRCP-2130-2G	WRSCP-2130-2SS	55 lbs
21" x 36" x 40"	WRCP-2136-2	WRSCP-2136-2	WRCP-2136P-2	WRCP-2136GY-2	-	47 lbs	WRCP-2136-2CG	WRSCP-2136SS-2S	54 lbs	WRCP-2136-2G	WRSCP-2136-2SS	61 lbs
21" x 42" x 40"	WRCP-2142-2	WRSCP-2142-2	WRCP-2142P-2	WRCP-2142GY-2	-	49 lbs	WRCP-2142-2CG	WRSCP-2142SS-2S	58 lbs	WRCP-2142-2G	WRSCP-2142-2SS	67 lbs
21" x 48" x 40"	WRCP-2148-2	WRSCP-2148-2	WRCP-2148P-2	WRCP-2148GY-2	-	53 lbs	WRCP-2148-2CG	WRSCP-2148SS-2S	62 lbs	WRCP-2148-2G	WRSCP-2148-2SS	71 lbs
21" x 60" x 40"	WRCP-2160-2	WRSCP-2160-2	WRCP-2160P-2	WRCP-2160GY-2	-	61 lbs	WRCP-2160-2CG	WRSCP-2160SS-2S	71 lbs	WRCP-2160-2G	WRSCP-2160-2SS	81 lbs
24" x 30" x 40"	WRCP-2430-2	WRSCP-2430-2	WRCP-2430P-2	WRCP-2430GY-2	WRCP-2430BK-2	47 lbs	WRCP-2430-2CG	WRSCP-2430SS-2S	53 lbs	WRCP-2430-2G	WRSCP-2430-2SS	59 lbs
24" x 36" x 40"	WRCP-2436-2	WRSCP-2436-2	WRCP-2436P-2	WRCP-2436GY-2	WRCP-2436BK-2	51 lbs	WRCP-2436-2CG	WRSCP-2436SS-2S	57 lbs	WRCP-2436-2G	WRSCP-2436-2SS	63 lbs
24" x 42" x 40"	WRCP-2442-2	WRSCP-2442-2	WRCP-2442P-2	WRCP-2442GY-2	WRCP-2442BK-2	55 lbs	WRCP-2442-2CG	WRSCP-2442SS-2S	62 lbs	WRCP-2442-2G	WRSCP-2442-2SS	69 lbs
24" x 48" x 40"	WRCP-2448-2	WRSCP-2448-2	WRCP-2448P-2	WRCP-2448GY-2	WRCP-2448BK-2	57 lbs	WRCP-2448-2CG	WRSCP-2448SS-2S	65 lbs	WRCP-2448-2G	WRSCP-2448-2SS	73 lbs
24" x 60" x 40"	WRCP-2460-2	WRSCP-2460-2	WRCP-2460P-2	WRCP-2460GY-2	WRCP-2460BK-2	67 lbs	WRCP-2460-2CG	WRSCP-2460SS-2S	77 lbs	WRCP-2460-2G	WRSCP-2460-2SS	87 lbs
3 Wire Shelf Push Handle Utility Cart												
18" x 30" x 40"	WRCP-1830-3	WRSCP-1830-3	WRCP-1830P-3	WRCP-1830GY-3	WRCP-1830BK-3	48 lbs	WRCP-1830-3CG	WRSCP-1830SS-3S	54 lbs	WRCP-1830-3G	WRSCP-1830-3SS	66 lbs
18" x 36" x 40"	WRCP-1836-3	WRSCP-1836-3	WRCP-1836P-3	WRCP-1836GY-3	WRCP-1836BK-3	54 lbs	WRCP-1836-3CG	WRSCP-1836SS-3S	60 lbs	WRCP-1836-3G	WRSCP-1836-3SS	72 lbs
18" x 42" x 40"	WRCP-1842-3	WRSCP-1842-3	WRCP-1842P-3	WRCP-1842GY-3	WRCP-1842BK-3	57 lbs	WRCP-1842-3CG	WRSCP-1842SS-3S	64 lbs	WRCP-1842-3G	WRSCP-1842-3SS	78 lbs
18" x 48" x 40"	WRCP-1848-3	WRSCP-1848-3	WRCP-1848P-3	WRCP-1848GY-3	WRCP-1848BK-3	66 lbs	WRCP-1848-3CG	WRSCP-1848SS-3S	72 lbs	WRCP-1848-3G	WRSCP-1848-3SS	84 lbs
18" x 60" x 40"	WRCP-1860-3	WRSCP-1860-3	WRCP-1860P-3	WRCP-1860GY-3	WRCP-1860BK-3	75 lbs	WRCP-1860-3CG	WRSCP-1860SS-3S	82 lbs	WRCP-1860-3G	WRSCP-1860-3SS	96 lbs
21" x 30" x 40"	WRCP-2130-3	WRSCP-2130-3	WRCP-2130P-3	WRCP-2130GY-3	-	52 lbs	WRCP-2130-3CG	WRSCP-2130SS-3S	58 lbs	WRCP-2130-3G	WRSCP-2130-3SS	70 lbs
21" x 36" x 40"	WRCP-2136-3	WRSCP-2136-3	WRCP-2136P-3	WRCP-2136GY-3	-	58 lbs	WRCP-2136-3CG	WRSCP-2136SS-3S	65 lbs	WRCP-2136-3G	WRSCP-2136-3SS	79 lbs
21" x 42" x 40"	WRCP-2142-3	WRSCP-2142-3	WRCP-2142P-3	WRCP-2142GY-3	-	61 lbs	WRCP-2142-3CG	WRSCP-2142SS-3S	70 lbs	WRCP-2142-3G	WRSCP-2142-3SS	88 lbs
21" x 48" x 40"	WRCP-2148-3	WRSCP-2148-3	WRCP-2148P-3	WRCP-2148GY-3	-	67 lbs	WRCP-2148-3CG	WRSCP-2148SS-3S	76 lbs	WRCP-2148-3G	WRSCP-2148-3SS	94 lbs
21" x 60" x 40"	WRCP-2160-3	WRSCP-2160-3	WRCP-2160P-3	WRCP-2160GY-3	-	79 lbs	WRCP-2160-3CG	WRSCP-2160SS-3S	84 lbs	WRCP-2160-3G	WRSCP-2160-3SS	109 lbs
24" x 30" x 40"	WRCP-2430-3	WRSCP-2430-3	WRCP-2430P-3	WRCP-2430GY-3	WRCP-2430BK-3	58 lbs	WRCP-2430-3CG	WRSCP-2430SS-3S	64 lbs	WRCP-2430-3G	WRSCP-2430-3SS	76 lbs
24" x 36" x 40"	WRCP-2436-3	WRSCP-2436-3	WRCP-2436P-3	WRCP-2436GY-3	WRCP-2436BK-3	64 lbs	WRCP-2436-3CG	WRSCP-2436SS-3S	70 lbs	WRCP-2436-3G	WRSCP-2436-3SS	82 lbs
24" x 42" x 40"	WRCP-2442-3	WRSCP-2442-3	WRCP-2442P-3	WRCP-2442GY-3	WRCP-2442BK-3	70 lbs	WRCP-2442-3CG	WRSCP-2442SS-3S	77 lbs	WRCP-2442-3G	WRSCP-2442-3SS	91 lbs
24" x 48" x 40"	WRCP-2448-3	WRSCP-2448-3	WRCP-2448P-3	WRCP-2448GY-3	WRCP-2448BK-3	73 lbs	WRCP-2448-3CG	WRSCP-2448SS-3S	81 lbs	WRCP-2448-3G	WRSCP-2448-3SS	97 lbs
24" x 60" x 40"	WRCP-2460-3	WRSCP-2460-3	WRCP-2460P-3	WRCP-2460GY-3	WRCP-2460BK-3	88 lbs	WRCP-2460-3CG	WRSCP-2460SS-3S	98 lbs	WRCP-2460-3G	WRSCP-2460-3SS	118 lbs



Millenia Drying Racks



BUILT FOR EFFICIENT AND CONVENIENT DRYING

NEW

Drying racks allow items to be spread out reducing the risk of mold and bacteria growth. All drying rack complete units include 4 shelf frames with corresponding cradles or shelf plates, 4 posts and mobile kit.

MODEL NO.	NOMINAL DIMENSIONS W" x L" x H"	SHIP WGT
Millenia Universal Drying Racks		
QPM243068DR	24" x 30" x 68"	58 lbs
QPM244268DR	24" x 42" x 68"	67 lbs
QPM245468DR	24" x 54" x 68"	78 lbs
Millenia Pronged Drying Racks		
QPM243068PDR1	24" x 30" x 68"	54 lbs
QPM244268PDR1	24" x 42" x 68"	62 lbs
QPM245468PDR1	24" x 54" x 68"	70 lbs
QPM243068PDR2	24" x 30" x 68"	62 lbs
QPM244268PDR2	24" x 42" x 68"	74 lbs
QPM245468PDR2	24" x 54" x 68"	86 lbs
Millenia Waved Drying Racks		
QPM243068WDR	24" x 30" x 68"	62 lbs
QPM244268WDR	24" x 42" x 68"	74 lbs
QPM245468WDR	24" x 54" x 68"	86 lbs



SANITATION WITH DURABILITY



UNIVERSAL DRYING RACK COMPLETE UNIT
QPM244268DR

FITS FROM 24-43 TRAYS PER RACK

FITS FROM 10-17 PANS PER RACK



NEW
M2448W46DR
Green Polymer and Gray Epoxy Finish

Drying Rack Unit - 4 Shelf Units



Drying rack allows you to store and dry cutting boards, trays and pans. All units include 2 cutting board/trays and 2 pan drying racks. **Finish:** Proform Green/Gray Epoxy

MODEL NO.	DIMENSIONS W" x L" x H"	SHIP WGT
Complete Drying Rack Units		
M2436W46DR	24" x 36" x 63"	134 lbs
M2448W46DR	24" x 48" x 63"	162 lbs
M2460W46DR	24" x 60" x 63"	194 lbs



Tool Caddy



Industrial strength, hand-held caddy ideal for tools and supplies. This portable, high density polypropylene caddy has extra strength ribs for support. Deep compartments make transporting tools, supplies and loose items super easy.

Available in: ● Blue ● Gray

MODEL NO.	OUTSIDE DIMENSIONS L" x W" x H"	CTN QTY	CTN WGT
TC-500	13-3/8" x 18-1/4" x 5-1/2"	6	14 lbs

*Overall height including handle is 9-1/8". To order a full carton add CS suffix to Model No. TC-500BLCS. Note: Must be ordered in carton quantities only.



TC-500



Industrial-strength polypropylene

Deep compartments are ideal for cleaning sanitation items, hardware or cleaning supplies. Inside pockets measures 16-3/4"L x 4-1/2"W

Comfortable grip handle even when carrying heavy loads 9-1/8"H

Perfect for tools, parts and janitorial supplies



Tool Box



This tough Tool Box will not warp or bend even when it is loaded to capacity. Ideal for carrying hand tools, hardware or small to medium sized items. Handle provides comfortable smooth grip. Flush top surface for convenient stacking and storing. Manufactured from heavy-duty polypropylene.

Available in: ● Red ● Clear

MODEL NO.	OUTSIDE DIMENSIONS L" x W" x H"	CTN QTY	CTN WGT
TB12	5-1/2" x 12" x 4-1/8"	12	9 lbs
TB12CL	5-1/2" x 12" x 4-1/8"	12	9 lbs

To order a full carton add CS suffix to Model No. TB12CS. Note: Must be ordered in carton quantities only.



TB12CL CLEAR COLOR



TB12

IDEAL FOR CARRYING HAND TOOLS

TOUGH, DURABLE, LOW COST



NPB1076



Economy All-Purpose Nesting Parts Bin



Organize your small to medium items with our tough, durable, high density Nesting Parts Bins. Bins save space and nest when empty. Manufactured from heavy-duty polypropylene.

Available in: ○ White ● Black

MODEL NO.	OUTSIDE DIMENSIONS L" x W" x H"	INSIDE BOTTOM DIMENSIONS L" x W" x H"	CTN QTY	CTN WGT
NPB1076	10-1/4" x 7-1/2" x 6"	8" x 5-1/2" x 5-3/4"	20	10 lbs

Inside top width: 6-1/2". Inside height to open hopper front: 3-3/4". To order a full carton add CS suffix to Model No. NPB1076BKCS. Note: Must be ordered in carton quantities only.

HEAVY-DUTY INDUSTRIAL-STRENGTH PLASTIC

Wrench Holder



Versatile Wrench Holder can be mounted on any wall surface. Manufactured from high impact polystyrene and can hold up to 15 wrenches of different sizes. Mounting hardware is not included.

Available in: ● Black

MODEL NO.	OUTSIDE DIMENSIONS L" x W" x H"	CTN QTY	CTN WGT
WH-15	1" x 7-1/8" x 11-5/8"	12	5 lbs



WH-15 (Wrenches not included)



Ultra Stack & Hang Bins



PERFORMANCE FEATURES:

- Available in 22 sizes
- Standard colors: Blue, Green, Ivory, Red, Yellow, Black and Clear
Crystal Clear and Stone color are available in select sizes
(additional colors available on request, subject to upcharge and minimum run quantity)
- Bins are made from heavy-duty, virgin grade, high density FDA approved polypropylene
- Large label slot provide easy label insertion and parts' identification
- Extra wide stacking ledge ensures stability for high stacking
- Reinforced design adds strength and prevents spreading of side walls of bins
- Will not rust or corrode, unaffected by weak acids and alkalis, and are waterproof
- Autoclavable up to 250°F
- Interchangeable with other manufactured brands of bins

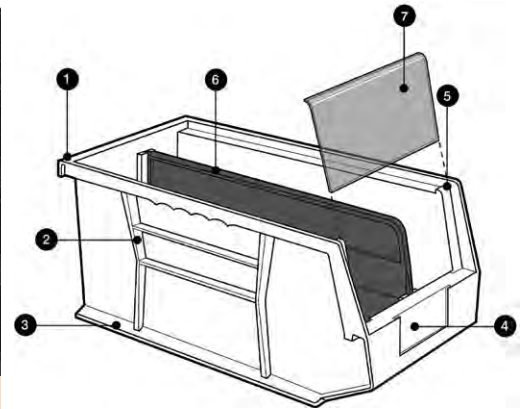

- 1 Full width hanger supports bin when hanging from louvered panels or rails
- 2 Reinforced rib design adds strength and prevents spreading of side walls
- 3 Extra-wide stacking ledge for secure stacking
- 4 Large front label slot allows larger bar code scanning and content identification
- 5 Anti-slide stop prevents stacked bins from shifting forward
- 6 Optional dividers increase storage options
- 7 Optional windows maximize storage capacity, prevent spillage and protect parts from dust and dirt



QUS230BL with COV230

Lid pivots up and down via insertion in holes in rear of bin
(Sold separately)



QUS239CL and QUS240YL

Shown with optional clear window front and dividers in clear or black
(Sold separately)



MOBILE ULTRA BIN

Ideal for transport of heavy and bulky parts. Bin comes with 4 swivel, 3" polyurethane casters, all with brakes, allowing up to 250 lb. mobile load capacity

CLEAR LABEL HOLDER

Clear label holders and laser label inserts slide into front label slot of all bins.
(Sold in packages of 25)



POLYMER DOLLY

DLY-3018 Dolly with padded rubber trim, available in Blue. Dimensions 30"L x 18"W. Set of four 4" x 1-1/4" non-marking swivel poly casters, 1,000 lb. load capacity.
(Bin sold separately)



ATTACHED PULL RING

Allows dolly to be pulled with ease



MODEL NO.	DESCRIPTION	CTN WGT
DLY-3018	Dolly with Padded Rubber Trim	19 lbs
HANDLE-DLY	32" Dolly Pull Rod with Handle	2 lbs

Bins sold separately



32" Dolly Pull Rod with handle
Finish: Chrome



NEW
CRYSTAL CLEAR

22 SIZES AND 9 COLORS AVAILABLE
THE LARGEST SELECTION ANYWHERE

CLEAR
AVAILABLE **VIEW**

QUS241



QUS242



NEW



QUS210CC
Crystal Clear color
in select sizes

QUS230

Shown with optional
Clear Lid



QUS234



QUS238

QUS255



QUS260



QUS220



QUS224

QUS239

Shown with optional
Black Divider



QUS235

QUS240



QUS248



QUS265



QUS245

Shown with optional
Clear Window and Black Divider



QUS250



QUS270

Shown with
optional
Clear
Window



QUS232



QUS236



Ultra Stack & Hang Bins



HEAVY-DUTY
LIFETIME USE

Bin Dimensions Guide
L (length) W (width) H (height)
X (inside bottom length)

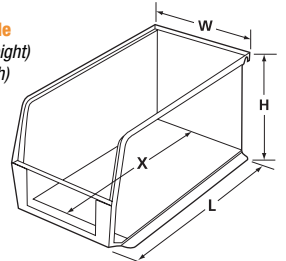

Organize your inventory with these strong bins, manufactured with FDA approved materials. Front, back and side grips for easy handling. Built-in rear hanger allows bins to hang from louvered panels or rails. Optional clear injection molded crystal styrene window front increases bin capacity and provides quick view of bin contents. Dividers, available in black or clear, maximize flexibility and keep contents organized. Wide stacking ledge and anti-slide lock keep stacked bins steady and prevent forward shifting. Water, rust, and corrosion proof. Easily cleaned with soap and water and impervious to most chemicals. Large molded front label slots for ID labels. Autoclavable up to 250°F and resistant to extreme cold. Guaranteed not to break or crack under normal load conditions.

QUS210, QUS220, QUS224, QUS230, QUS234, QUS240, QUS250, QUS265, QUS270 also available in: ● Stone
NEW **QUS210, QUS220, QUS230, QUS240 also available in:** ○ Crystal Clear

Available in: ● Blue ● Green ● Ivory ● Red ● Yellow ● Black ● Clear

MODEL NO.	OUTSIDE DIMENSIONS L" x W" x H"	INSIDE DIMENSIONS L" x W" x H"	X"	CTN QTY	CTN WGT	BIN LOAD CAPACITY*	CLEAR WINDOW	CTN QTY	***DIVIDER & CROSS DIVIDER	CTN QTY	DIVIDER SLOTS	CLEAR LABEL HOLDER & INSERT	CLEAR LID	CTN QTY
QUS210	5-3/8" x 4-1/8" x 3"	4-3/4" x 3-7/16" x 2-13/16"	4"	24	6 lbs	15 lbs	-	-	DUS210	6	1	LTR-1300	COV210	24
QUS220	7-3/8" x 4-1/8" x 3"	6-3/4" x 3-7/16" x 2-13/16"	6"	24	8 lbs	15 lbs	-	-	DUS220	6	1	LTR-1300	COV220	24
QUS221	9-1/4" x 6" x 5"	8-1/2" x 5-1/8" x 4-1/2"	7-1/4"	12	6 lbs	25 lbs	-	WUS221	12	DUS221	6	1	LTR-1754	-
QUS224	10-7/8" x 4-1/8" x 4"	10-1/4" x 3-3/16" x 3-3/4"	9"	12	8 lbs	35 lbs	WUS224	12	DUS224	6	1	LTR-1253	COV224	12
QUS230	10-7/8" x 5-1/2" x 5"	10-1/4" x 4-3/8" x 4-3/4"	9"	12	10 lbs	35 lbs	WUS230/234	12	DUS230/235	6	1	LTR-1754	COV230	12
QUS232	5-3/8" x 11" x 3"	4-3/4" x 10-1/8" x 2-13/16"	4"	8	5 lbs	35 lbs	-	-	DUS210	6	3	LTR-1300	COV232	8
QUS234	14-3/4" x 5-1/2" x 5"	14-1/16" x 4-3/8" x 4-3/4"	12-13/16"	12	14 lbs	55 lbs	WUS230/234	12	DUS234	6	1	LTR-1754	-	-
QUS235	10-7/8" x 11" x 5"	10-1/4" x 10" x 4-3/4"	9"	6	10 lbs	55 lbs	WUS235	6	DUS230/235	6	3	LTR-1754	COV235	6
QUS236	7-3/8" x 11" x 3"	6-3/4" x 10-1/8" x 2-13/16"	6"	8	9 lbs	35 lbs	-	-	DUS220	6	3	LTR-1300	COV236	8
QUS238	18" x 5-1/2" x 5"	17-1/8" x 4-3/8" x 4-3/4"	15-7/8"	12	16 lbs	45 lbs	WUS230/234	12	DUS238 CRDUS238	6	1	LTR-1754	COV238	12
QUS239	10-3/4" x 8-1/4" x 7"	10" x 6-9/16" x 6-3/4"	8"	6	10 lbs	55 lbs	WUS239/240	6	DUS239	6	1	LTR-1754	COV239	6
QUS240	14-3/4" x 8-1/4" x 7"	14" x 6-9/16" x 6-3/4"	12"	12	24 lbs	65 lbs	WUS239/240	6	DUS240/250	6	1	LTR-1754	COV240	12
QUS241	13-5/8" x 8-1/4" x 6"	12-1/2" x 6-3/4" x 5-3/8"	11-1/8"	12	22 lbs	65 lbs	WUS241	12	DUS241	6	1	LTR-1754	-	-
QUS242	13-5/8" x 8-1/4" x 8"	12-1/2" x 6-3/4" x 7-3/8"	11-1/8"	12	25 lbs	65 lbs	WUS242	12	DUS242	6	1	LTR-1754	-	-
QUS245	10-7/8" x 16-1/2" x 5"	9-3/4" x 15" x 4-3/4"	9"	6	13 lbs	65 lbs	WUS245	6	DUS245	6	3	LTR-1754	-	-
QUS248	18" x 8-1/4" x 7"	17" x 6-1/2" x 6-1/2"	15-1/4"	6	19 lbs	80 lbs	WUS239/240	6	DUS248 CRDUS248	6	3	LTR-1754	COV248	6
QUS250	14-3/4" x 16-1/2" x 7"	14" x 14-3/4" x 6-3/4"	12"	6	21 lbs	80 lbs	WUS250	6	DUS240/250	6	3	LTR-1754	-	-
QUS255	16" x 11" x 8"	15-1/8" x 10" x 7-3/4"	11-5/8"	4	14 lbs	80 lbs	WUS255	4	DUS255	6	3	LTR-1754	-	-
QUS260	18" x 11" x 10"	17" x 9-1/2" x 9-3/4"	14-3/16"	4	17 lbs	80 lbs	WUS260	4	DUS260	6	3	LTR-1754	-	-
QUS265	18" x 8-1/4" x 9"	17-1/8" x 6-3/4" x 8-1/4"	14-1/2"	6	17 lbs	65 lbs	WUS265	6	DUS265	6	1	LTR-1754	-	-
QUS270	18" x 16-1/2" x 11"	17-1/8" x 14-3/4" x 10-1/4"	14"	3	16 lbs	80 lbs	WUS270	3	DUS270 CRDUS270	6	3	LTR-2400	-	-
QUS275MOB**	18" x 16-1/2" x 11"	17-1/8" x 14-3/4" x 10-1/4"	14"	3	25 lbs	-	WUS270	3	DUS270 CRDUS270	6	3	LTR-2400	-	-

*When attached to panels or rails **With casters, overall height is 14" ***To order clear dividers add **CL** suffix to divider Model No. **DUS210CL**. To order a full carton add **CS** suffix to Model No. **QUS210GNCS**. Note: Bins must be ordered in carton quantities only.



Giant Open Hopper Steel Shelving Systems - Complete Packages

These economical high density bin storage systems include heavy-duty giant stack bins with open hopper fronts for easy access. Optional clear window fronts maximize capacity, prevent spillage and convert the bin to a true tote. Optional dividers keep contents organized - available on **pg. 93**. Heavy-duty, industrial grade shelving with 400 lb. load capacity per shelf.



COMPLETE PACKAGES
WITH BINS

12" Deep Systems

18" Deep Systems



QSBU-230240

12"D x 36"W x 75"H
10 shelves and 36 QUS230
10-7/8"L x 5-1/2"W x 5"H bins
and 12 QUS240
14-3/4"L x 8-1/4"W x 7"H bins



QSBU-239

12"D x 36"W x 75"H
8 shelves and 28 QUS239
10-3/4"L x 8-1/4"W x 7"H bins



QSBU-255

18"D x 36"W x 75"H
8 shelves and 21 QUS255
16"L x 11"W x 8"H bins
(Windows sold separately)



QSBU-260

18"D x 36"W x 75"H
6 shelves and 15 QUS260
18"L x 11"W x 10"H bins
(Windows and dividers sold separately)



QSBU-240

12"D x 36"W x 75"H
8 shelves and 28 QU240
14-3/4"L x 8-1/4"W x 7"H bins



QSBU-250

12"D x 36"W x 75"H
8 shelves and 14 QUS250
14-3/4"L x 16-1/2"W x 7"H bins



QSBU-265

18"D x 36"W x 75"H
7 shelves and 24 QUS265
18"L x 8-1/4"W x 9"H bins



QSBU-270

18"D x 36"W x 75"H
6 shelves and 10 QUS270
18"L x 16-1/2"W x 11"H bins

Bins available in: ● Blue ● Green ● Ivory ● Red ● Yellow ● Black ● Clear *(One color per unit)*



Giant Open Hopper Wire Shelving Systems - Complete Packages



COMPLETE PACKAGES
WITH BINS



MOBILIZE YOUR WIRE SHELVING

DB - Donut Bumper
Non-marking donut bumper used to protect walls and help cushion impact.

WR-00H (Mobile Kit)*
Set of four swivel thermoplastic resin 5" x 1-1/4" casters, two with brakes. Up to 1,200 lb. load capacity. *Mobile kits recommended only for shelves 18" and deeper.

12" and 14" Deep Systems

18" Deep Systems



WR8-239
12"W x 36"L x 74"H
8 shelves and 28 QUS239
10-3/4"L x 8-1/4"W x 7"H bins



WR8-240
14"W x 36"L x 74"H
8 shelves and 28 QUS240
14-3/4"L x 8-1/4"W x 7"H bins



WR8-255
18"W x 36"L x 74"H
8 shelves and 21 QUS255
16"L x 11"W x 8"H bins



WR6-260
18"W x 36"L x 74"H
6 shelves and 15 QUS260
18"L x 11"W x 10"H bins



WR8-250
14"W x 36"L x 74"H
8 shelves and 14 QUS250
14-3/4"L x 16-1/2"W x 7"H bins



WR10-230240
14"W x 36"L x 74"H
10 shelves and 36 QUS230
10-7/8"L x 5-1/2"W x 5"H bins and
12 QUS240 14-3/4"L x 8-1/4"W x 7"H bins



WR6-265
18"W x 36"L x 74"H
6 shelves and 20 QUS265
18"L x 8-1/4"W x 9"H bins



WR5-270
18"W x 36"L x 74"H
5 shelves and 8 QUS270
18"L x 16-1/2"W x 11"H bins

Bins available in: ● Blue ● Green ● Ivory ● Red ● Yellow ● Black ● Clear (One color per unit)



NEW CRYSTAL CLEAR BINS

Introducing our revolutionary crystal clear hang and stack bin, a cutting-edge solution designed for any application where transparency is paramount, our product stands out as a game-changer

CRYSTAL CLEAR



QUS210CC

QUS240CC

QUS230CC

QUS220CC

HEAVY-DUTY
LIFETIME USE

CRYSTAL-CLEAR
VISIBILITY

Crystal Clear Ultra Stack & Hang Bins



Our crystal clear hang and stack bins provides unparalleled clarity, allowing a direct and unobstructed view of products or materials. This transparency enhances safety and efficiency in all settings.

PERFORMANCE FEATURES:

- FDA approved clear thermoplastic
- Large label slot provide easy label insertion and parts identification
- Will not rust or corrode, unaffected by weak acids and alkalis, and are waterproof
- Autoclavable up to 250°F

Available in: Crystal Clear

MODEL NO.	OUTSIDE DIMENSIONS L" x W" x H"	INSIDE DIMENSIONS L" x W" x H"	X"	CTN QTY	CTN WGT	BIN LOAD CAPACITY*	CLEAR WINDOW	CTN **DIVIDER & CROSS DIVIDER QTY	CTN DIVIDER QTY	CTN DIVIDER SLOTS	CLEAR LABEL HOLDER & INSERT	CLEAR LID	CTN QTY
QUS210CC	5-3/8" x 4-1/8" x 3"	4-3/4" x 3-7/16" x 2-13/16"	4"	24	6 lbs	15 lbs	-	- DUS210	6	1	LTR-1300	COV210	24
QUS220CC	7-3/8" x 4-1/8" x 3"	6-3/4" x 3-7/16" x 2-13/16"	6"	24	8 lbs	15 lbs	-	- DUS220	6	1	LTR-1300	COV220	24
QUS230CC	10-7/8" x 5-1/2" x 5"	10-1/4" x 4-3/8" x 4-3/4"	9"	12	10 lbs	35 lbs	WUS230/234	12 DUS230/235	6	1	LTR-1754	COV230	12
QUS240CC	14-3/4" x 8-1/4" x 7"	14" x 6-9/16" x 6-3/4"	12"	12	24 lbs	65 lbs	WUS239/240	6 DUS240/250	6	1	LTR-1754	COV240	12

*When attached to panels or rails **To order clear dividers add CL suffix to divider Model No. DUS210CL. To order a full carton add CS suffix to Model No. QUS210CCS. Note: Bins must be ordered in carton quantities only.



Super Tuff Euro Drawers



Super Tuff Euro Drawers are available in nine sizes and four colors and are designed for efficient organization of heavy parts, supplies, tools or equipment. Super Tuff Euro Drawers are injection molded from virgin grade high impact polystyrene and are virtually unbreakable. These heavy-duty drawers can be used on Quantum's open and closed shelf units and pick racks.

Available in: ● Blue ● Red ● Yellow ● Gray

MODEL NO.	OUTSIDE DIMENSIONS L" x W" x H"	INSIDE DIMENSIONS L" x W" x H"	CTN QTY	CTN WGT	NUMBER OF DIVIDER SLOTS	DIVIDER	DIV CTN QTY
QED401	11-5/8" x 5-9/16" x 2-1/8"	10-1/4" x 5-1/8" x 2"	24	17 lbs	8	DIV401	4
QED501	11-5/8" x 3-3/4" x 4-5/8"	10-1/4" x 3-1/4" x 4-3/8"	24	19 lbs	8	DIV501/604	4
QED601	11-7/8" x 5-9/16" x 4-5/8"	10-3/4" x 5-1/8" x 4-3/8"	24	24 lbs	8	DIV6123	4
QED701	11-5/8" x 8-3/8" x 4-5/8"	10-1/4" x 7-3/4" x 4-3/8"	24	31 lbs	8	DIV701/606	4
QED801	11-5/8" x 11-1/8" x 4-5/8"	10-1/4" x 10-5/8" x 4-3/8"	12	19 lbs	8	DIV801	4
QED604	17-5/8" x 3-3/4" x 4-5/8"	16-1/2" x 3-1/4" x 4-1/4"	24	29 lbs	15	DIV501/604	4
QED602	17-3/4" x 5-9/16" x 4-5/8"	16-1/2" x 5-1/8" x 4-3/8"	24	32 lbs	13	DIV6123	4
QED606	17-5/8" x 8-3/8" x 4-5/8"	16-1/4" x 7-7/8" x 4-3/8"	24	46 lbs	13	DIV701/606	4
QED603	24" x 5-9/16" x 4-5/8"	22-5/8" x 5-1/8" x 4-3/8"	12	25 lbs	18	DIV6123	4

Rear tab adds an additional 3/8" to rear height. To order a full carton add **CS** suffix to Model No. QED401BLCS. **Note:** Bins must be ordered in carton quantities only.

PERFORMANCE FEATURES:

- Available in 9 sizes
- Bins are injection molded from a virgin grade high impact polystyrene and are virtually unbreakable
- Drawers are completely waterproof
- Drawers are oil and chemical resistant
- Smooth front curved pull handle has ample room for adhesive labels or bar codes
- Front handle has 3/4" opening for convenient easy gripping
- Full width back ledge ensures spill free use
- Optional dividers are full height for subdividing bins and prevents mixing of parts
- Available in four colors ideal for color coding inventory: Blue, Yellow, Red and Gray

9 SIZES AND 4 COLORS AVAILABLE

Full width back ledge ensures spill free use when used on shelving

Multiple divider grooves allow for customized and optimal storage

Multiple molded-in divider slots

Smooth front curved pull handle has ample room for adhesive labels or bar codes

Front handle has 3/4" opening for convenient easy gripping

Injection molded from virgin grade high impact polystyrene and are virtually unbreakable

AL-23
2" x 3-1/2"
Adhesive clear label holder and inserts. Fits all sizes of drawers 5-9/16"W and wider except QED401. Package of 24 (Sold separately)



12" Deep Euro Drawers



HEAVY-DUTY DRAWERS VIRTUALLY UNBREAKABLE

18" Deep Euro Drawers

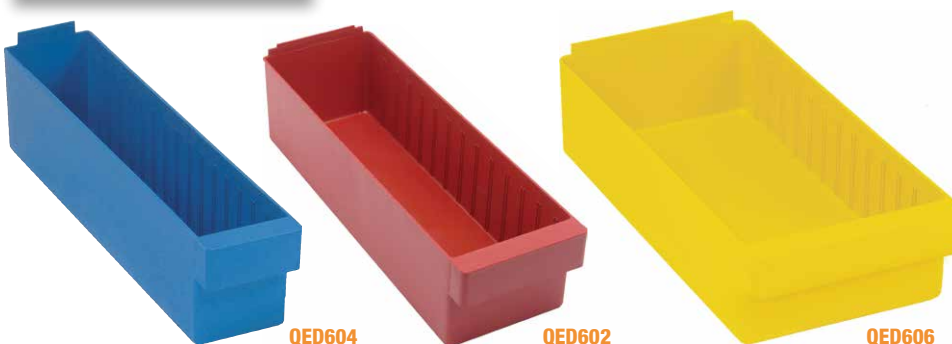

24" Deep Euro Drawer





12 SIZES AVAILABLE



Exclusive! Mesh Stack & Hang Bins



New patented wire Mesh Bins are an industry exclusive. Our innovative mesh design offers a bright-chrome finish and a 3/8" x 3/8" grid pattern allowing complete visibility of the bin's contents. This unique mesh pattern provides a dust and dirt free storage environment. Ultra strong design allows for superior hang capacity perfect for industrial parts storage or anything where hang capacities are vital. Quantum's Mesh Bins feature a rear hanger that allows them to hang from any louvered wall panel or rail system and optional side stacking ledge which allow bins to stack one on top of the other. The open hopper design allows for easy picking while allowing visual access to stored contents. Two styles of optional label holders are available for all Mesh Bins. **Finish:** Chrome

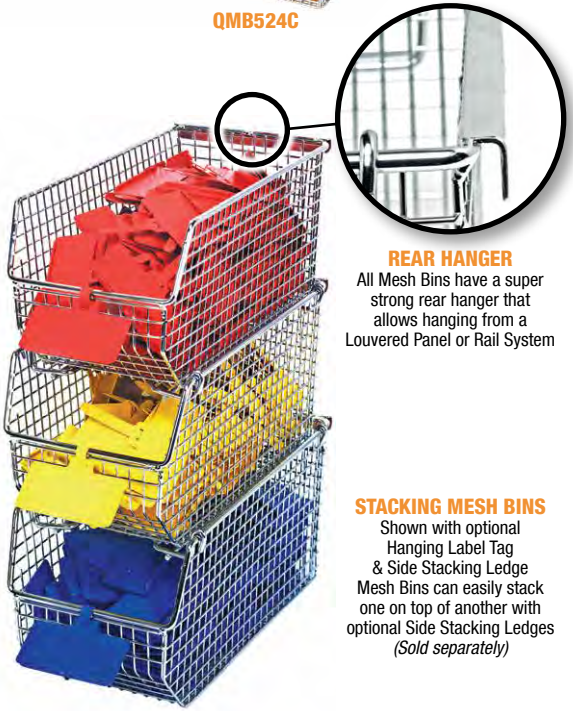

REAR HANGER
All Mesh Bins have a super strong rear hanger that allows hanging from a Louvered Panel or Rail System

STACKING MESH BINS
Shown with optional Hanging Label Tag & Side Stacking Ledge Mesh Bins can easily stack one on top of another with optional Side Stacking Ledges (Sold separately)

MODEL NO.	OUTSIDE DIMENSIONS L" x W" x H"	INSIDE DIMENSIONS L" x W" x H"	CTN QTY	CTN WGT	SIDE STACKING LEDGE SOLD PER PAIR	DIVIDER
QMB510C	5-1/4" x 4-1/4" x 3"	4-3/4" x 3" x 2-3/4"	20	12 lbs	HMB510C	DMB510C
QMB520C	7-1/4" x 4-1/4" x 3"	6-3/4" x 3" x 2-3/4"	20	15 lbs	HMB520C	DMB520C
QMB524C	11" x 4-3/4" x 4"	10-3/8" x 3-1/2" x 3-3/4"	10	15 lbs	HMB530C/535C	DMB524C
QMB530C	10-3/4" x 5-1/2" x 5"	10-1/4" x 4" x 4-3/4"	10	12 lbs	HMB530C/535C	DMB530C/535C
QMB534C	15" x 6" x 5"	14-1/4" x 4-3/4" x 4-3/4"	10	17 lbs	HMB540C/550C	DMB534C
QMB535C	10-3/4" x 11" x 5"	10-1/4" x 9-3/4" x 4-3/4"	10	19 lbs	HMB530C/535C	DMB530C/535C
QMB539C	10-1/2" x 8" x 7"	10" x 6-5/8" x 6-5/8"	10	20 lbs	HMB539C	DMB539C
QMB540C	14-1/2" x 8" x 7"	14" x 6-5/8" x 6-5/8"	10	30 lbs	HMB540C/550C	DMB540C/550C
QMB550C	14-1/2" x 16-1/4" x 7"	14" x 14-7/8" x 6-5/8"	5	17 lbs	HMB540C/550C	DMB540C/550C
QMB560C	18-1/2" x 11" x 10-1/8"	18" x 9-5/8" x 9-7/8"	5	21 lbs	HMB560C/570C	DMB560C/570C
QMB565C	17-3/4" x 8-1/8" x 9"	17-1/8" x 5-1/4" x 8-3/4"	5	19 lbs	HMB565C	DMB565C
QMB570C	18-1/2" x 17-1/8" x 11-1/8"	18" x 15-5/8" x 10-7/8"	5	28 lbs	HMB560C/570C	DMB560C/570C

To order a full carton add **CS** suffix to Model No. QMB510C**CS**. Note: Bins must be ordered in carton quantities only.

2 LABEL HOLDER OPTIONS

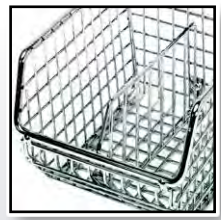

Shown with optional **Divider**
(Sold separately)



Shown with optional **Side Stacking Ledge Pair**
(Sold separately)

Accessories

**INSTANT VISIBILITY
NO DUST OR DIRT
BUILDUP
ALL WELDED**

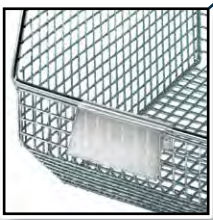

Shown with optional **HBL3C Clear Label Holder**
Fits 1-1/8" x 3" Label
(Sold separately)

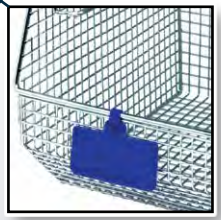

Shown with optional **PS-LH3 Hanging Label Tag**
Fits 1-3/8" x 3" Label

- CL ● RD ● YL ● BL ● GN
- OR ● PU (Sold separately)

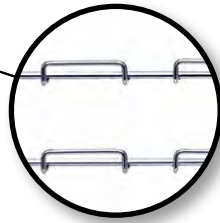

WLP-1836C
36" L x 18" H
Accepts all sizes of Ultra Stack & Hang Bins and Mesh Bins. Includes 8 direct mount clips. Up to 175 lb. load capacity.

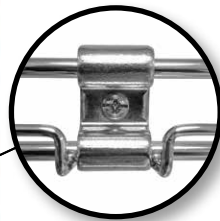

WLP-3036C
36" L x 30" H
Accepts all sizes of Ultra Stack & Hang Bins and Mesh Bins. Includes 12 direct mount clips. Up to 250 lb. load capacity.

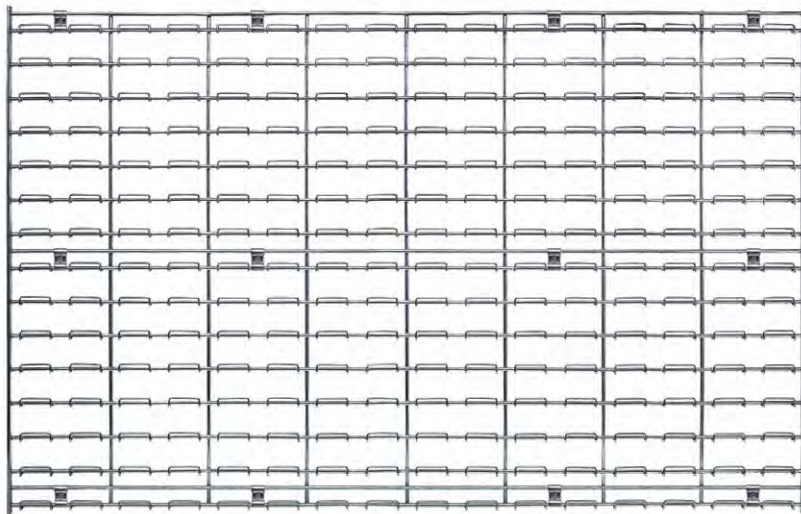

Exclusive! Wire Louvered Panels



Quantum's chrome Wire Louvered Panels offer a perfect mounting solution for all plastic hanging and wire mesh hanging bins. Quantum's exclusive offering of wire panels, available in three sizes, completely resist any buildup of dust or dirt. Included direct mounting clips enable fastening to any surface (*wall, wood, concrete, drywall, etc.*) a snap (**note: mounting screws are not included as they differ based on what type of surface the panels are being mounted to**). Offset mounting clips are also available, can be used in place of **WLP-DMC** if you want to have wire panel mounted offset (*away*) from a wall surface making it easier to clean behind the panel (*sold separately*). Manufactured of heavy-duty chrome wire, Quantum's wire panels will offer years of dependable and heavy-duty service.

MODEL NO.	DIMENSIONS L" x H"	CTN QTY	CTN WGT
Wire Wall Mounted Louvered Panels			
WLP-1836C	36" x 18" Wire Louvered Panel	1	12 lbs
WLP-3036C	36" x 30" Wire Louvered Panel	1	19 lbs
WLP-3048C	48" x 30" Wire Louvered Panel	1	26 lbs

Accessories



WLP-DMC
Direct Mount Clips - 4 pack
(Included with wire louvered panels)
Extra packages available (if needed). (Sold separately)



WLP-OSC
Offset Mount Clips - 4 pack
Offsets panel from wall surface allowing easy access to clean behind panel
(Sold separately)

WLP-3048C
48" L x 30" H
Accepts all sizes of Ultra Stack & Hang Bins and Mesh Bins. Includes 12 direct mount clips. Up to 300 lb. load capacity.

SIMPLE TO MOUNT
EASY TO CLEAN
ALL WELDED

MODEL NO.	QUANTITY OF MESH BINS TO FIT LOUVERED PANELS												QUANTITY OF ULTRA BINS TO FIT LOUVERED PANELS																					
	QMB 510	QMB 520	QMB 524	QMB 530	QMB 534	QMB 535	QMB 539	QMB 540	QMB 550	QMB 560	QMB 565	QMB 570	QUS 200	QUS 210	QUS 220	QUS 221	QUS 224	QUS 230	QUS 232	QUS 234	QUS 235	QUS 236	QUS 238	QUS 239	QUS 240	QUS 241	QUS 242	QUS 245	QUS 248	QUS 250	QUS 255	QUS 260	QUS 265	QUS 270
WLP-1836C	32	32	18	18	18	9	8	8	4	3	4	2	32	32	32	18	18	18	12	18	9	12	18	8	8	8	8	6	8	4	6	3	4	2
WLP-3036C	56	56	30	30	30	15	16	16	6	6	8	6	56	56	56	30	30	30	21	30	15	21	30	16	16	16	16	10	16	6	9	6	8	6
WLP-3048C	77	77	40	40	40	20	20	20	8	12	15	6	77	77	77	40	40	40	28	40	20	28	40	20	20	20	20	10	20	8	12	12	15	6

See pg. 93 & 98 for bin dimensions



STACKABLE SHELF BIN

10 SIZES AND 5 COLORS AVAILABLE



Exclusive! Stackable Shelf Bins



Quantum's exclusive Stackable Shelf Bins are an industry first and are ideal for medium size and large or heavy item storage. These strong, durable polypropylene bins are available in 4 lengths and 3 widths. 12", 14" and 18" deep bins have a built in rear hanger which allows bin to hang from louvered panels and rails. Bins have a raised front opening when compared to any like product allowing you to truly maximize the complete bin's storage capacity. Optional cross dividers allow flexibility and keep parts organized. Waterproof bins resist rust and corrosion. Large molded in front label slots for ID labels. Autoclavable up to 250°F and resistant to extreme cold.

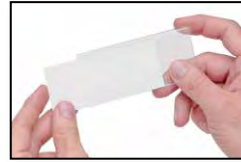

LTR-2400
Clear Label Holder and Insert
Package of 25.



STACKABLE SHELF BIN
Shown with optional Divider and DLT-6 Divider Label Tabs attach to existing dividers to improve the visibility of bin labels and scanning of barcodes. Package of 6. (Dividers and Label Tabs sold separately)

Available in: ● Blue ● Gray ● Ivory ● Black ● Orange

MODEL NO.	OUTSIDE DIMENSIONS L" x W" x H"	INSIDE DIMENSIONS L" x W" x H"	X"	CTN QTY	CTN WGT	DIVIDER	CTN QTY	CTN WGT	CLEAR LABEL HOLDER & INSERT
SSB423	12" x 8-1/4" x 7"	11-1/2" x 7-3/8" x 6-1/2"	7-1/2"	6	9 lbs	DSS403	6	1 lb	LTR-2400
SSB425	12" x 11" x 7"	11-1/2" x 10-1/8" x 6-1/2"	7-1/2"	6	11 lbs	DSS405	6	2 lbs	LTR-2400
SSB441	14" x 6" x 7"	13-1/2" x 5-3/8" x 6-1/2"	9-3/8"	6	8 lbs	DSS401	6	1 lb	LTR-2400
SSB443	14" x 8-1/4" x 7"	13-1/2" x 7-3/8" x 6-1/2"	9-3/8"	12	18 lbs	DSS403	6	1 lb	LTR-2400
SSB445	14" x 11" x 7"	13-1/2" x 10-1/8" x 6-1/2"	9-3/8"	6	12 lbs	DSS405	6	2 lbs	LTR-2400
SSB461	18" x 6" x 7"	17-1/2" x 5-3/8" x 6-1/2"	13-1/2"	6	11 lbs	DSS401	6	1 lb	LTR-2400
SSB463	18" x 8-1/4" x 7"	17-1/2" x 7-3/8" x 6-1/2"	13-3/8"	6	12 lbs	DSS403	6	1 lb	LTR-2400
SSB465	18" x 11" x 7"	17-1/2" x 10-1/8" x 6-1/2"	13-3/8"	6	15 lbs	DSS405	6	2 lbs	LTR-2400
SSB483*	20-1/2" x 8-1/4" x 7"	20" x 7-3/8" x 6-1/2"	15-7/8"	6	14 lbs	DSS403	6	1 lb	LTR-2400
SSB485*	20-1/2" x 11" x 7"	20" x 10-1/8" x 6-1/2"	15-7/8"	6	17 lbs	DSS405	6	2 lbs	LTR-2400

*Do not have rear hanger. To order a full carton add CS suffix to Model No. SSB423BLCS. Note: Bins must be ordered in carton quantities only.

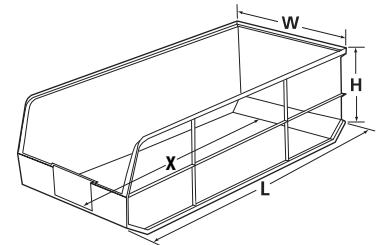

Bin Dimensions Guide
L (length) W (width) H (height)
X (inside length)

PERFORMANCE FEATURES:

- Available in 10 sizes
- Standard colors: Blue, Gray, Ivory, Black and Orange (additional colors available on request, subject to upcharge and minimum runs)
- Bins are made from heavy-duty, virgin, high density FDA approved polypropylene
- Large label slot provide easy label insertion and parts identification
- Extra wide stacking ledge assures stability for high stacking
- Reinforced design adds strength and prevents spreading
- Will not rust or corrode, unaffected by weak acids and alkalis, and are waterproof
- Autoclavable up to 250°F





Up to 400 lb.
LOAD CAPACITY
PER SHELF

Stackable Shelf Bin Steel Shelving Systems
- Complete Packages

Bins available in: ● Blue ● Gray ● Ivory ● Black ● Orange

(One color per unit)

MODEL NO.	OUTSIDE DIMENSIONS D" x W" x H"	NO. OF SHELVES	NO. OF BINS	BIN DIMENSIONS L" x W" x H"	SHIP WGT
1275-423	12" x 36" x 75"	8	28 SSB423	12" x 8-1/4" x 7"	129 lbs
1275-425	12" x 36" x 75"	8	21 SSB425	12" x 11" x 7"	126 lbs
1275-441	12" x 36" x 75"	8	35 SSB441	14" x 6" x 7"	134 lbs
1275-443	12" x 36" x 75"	8	28 SSB443	14" x 8-1/4" x 7"	129 lbs
1275-445	12" x 36" x 75"	8	21 SSB445	14" x 11" x 7"	129 lbs
1875-461	18" x 36" x 75"	8	35 SSB461	18" x 6" x 7"	173 lbs
1875-463	18" x 36" x 75"	8	28 SSB463	18" x 8-1/4" x 7"	165 lbs
1875-465	18" x 36" x 75"	8	21 SSB465	18" x 11" x 7"	165 lbs
2475-483	24" x 36" x 75"	8	28 SSB483	20-1/2" x 8-1/4" x 7"	197 lbs
2475-483485	24" x 36" x 75"	8	12 SSB483	20-1/2" x 8-1/4" x 7"	195 lbs
			12 SSB485	20-1/2" x 11" x 7"	
2475-485	24" x 36" x 75"	8	21 SSB485	20-1/2" x 11" x 7"	194 lbs



2475-485
24"D x 36"W x 75"H
8 shelves and 21 SSB485
20-1/2"L x 11"W x 7"H bins

STACKABLE SHELF BIN

COMPLETE PACKAGES
WITH BINS



MOBILIZE YOUR WIRE SHELVING

DB - Donut Bumper
Non-marking donut bumper used to protect walls and help cushion impact.

WR-00H (Mobile Kit)*
Set of four swivel thermoplastic resin 5" x 1-1/4" casters, two with brakes.
Up to 1,200 lb. load capacity.
**Mobile kits recommended only for shelves 18" and deeper.*



WR8-463
18"W x 36"L x 74"H
8 shelves and 28 SSB463
18"L x 8-1/4"W x 7"H bins

Stackable Shelf Bin Wire Shelving Systems
- Complete Packages

Bins available in: ● Blue ● Gray ● Ivory ● Black ● Orange

Up to 800 lb.
LOAD CAPACITY
PER SHELF

(One color per unit)

MODEL NO.	OUTSIDE DIMENSIONS W" x L" x H"	NO. OF SHELVES	NO. OF BINS	BIN DIMENSIONS L" x W" x H"	SHIP WGT
WR8-423	12" x 36" x 74"	8	28 SSB423	12" x 8-1/4" x 7"	114 lbs
WR8-425	12" x 36" x 74"	8	21 SSB425	12" x 11" x 7"	107 lbs
WR8-441	14" x 36" x 74"	8	35 SSB441	14" x 6" x 7"	136 lbs
WR8-443	14" x 36" x 74"	8	28 SSB443	14" x 8-1/4" x 7"	129 lbs
WR8-445	14" x 36" x 74"	8	21 SSB445	14" x 11" x 7"	122 lbs
WR8-461	18" x 36" x 74"	8	35 SSB461	18" x 6" x 7"	190 lbs
WR8-463	18" x 36" x 74"	8	28 SSB463	18" x 8-1/4" x 7"	180 lbs
WR8-465	18" x 36" x 74"	8	21 SSB465	18" x 11" x 7"	184 lbs
WR8-483	21" x 36" x 74"	8	28 SSB483	20-1/2" x 8-1/4" x 7"	198 lbs
WR8-483485	21" x 36" x 74"	8	12 SSB483	20-1/2" x 8-1/4" x 7"	199 lbs
			12 SSB485	20-1/2" x 11" x 7"	
WR8-485	21" x 36" x 74"	8	21 SSB485	20-1/2" x 11" x 7"	198 lbs



HULK containers

10 SIZES AND 4 COLORS AVAILABLE



QUS952

QUS951

QUS954

QUS955

QUS953

QUS950



QUS957
Shown with optional cross divider

AL-23
2" x 3-1/2"
Adhesive clear label holder and inserts.
Package of 24 (Sold separately)



QUS953

Shown with optional divider, window front, adhesive label holder and insert



REAR LARGE HANDLE
Molded onto back of containers makes them easy to carry!



POLYMER DOLLY

DLY-3018 Dolly with padded rubber trim, available in Blue. Dimensions 30" L x 18" W. Set of four 4" x 1-1/4" non-marking swivel poly casters, up to 1,000 lb. load capacity. (Bin sold separately)



MOBILE HULK CONTAINER
Ideal for transport of heavy and bulky parts. Bin comes with 4 swivel, 3" polyurethane casters, all with brakes, allowing up to 250 lb. mobile load capacity

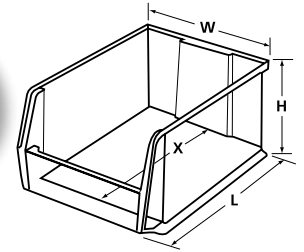

Bin Dimensions Guide
L (length) W (width)
H (height) X (inside length)

HULK 24" Containers



ATTACHED PULL RING
allows dolly to be pulled with ease

Organize and store your large and bulky items with these strong injection molded polypropylene, stackable containers. These extra large stacking containers offer a generous 2 feet in length to store your larger items. These huge stack bins are ideal for heavy-duty, extra deep shelving and are available in a variety of widths and heights. Heavy-duty front, back and side grips allow for easy handling. Optional clear styrene plastic window increases bin capacity and provides a quick view of the bin contents. Optional dividers maximize flexibility and keep contents organized. Wide stacking ledge and anti-slide lock keep stacked bins steady and prevent forward shifting. Waterproof bins are corrosion free. Bins are autoclavable up to 250°F and are resistant to extreme cold.

Available in: ● Blue ● Red ● Yellow ● Clear

MODEL NO.	OUTSIDE DIMENSIONS L" x W" x H"	INSIDE DIMENSIONS L" x W" x H"	X"	CTN QTY	CTN WGT	CLEAR WINDOW	CTN QTY	DIVIDER & CROSS DIVIDER	CTN QTY	CLEAR LABEL HOLDER & INSERT	CTN QTY
QUS950	23-7/8" x 8-1/4" x 7"	21-7/8" x 6-1/4" x 6-5/8"	19"	6	18 lbs	WUS950/970	6	DUS950	6	-	-
QUS951	23-7/8" x 8-1/4" x 9"	21-7/8" x 6-1/4" x 8-3/4"	18-3/4"	6	21 lbs	WUS951	6	DUS951	6	-	-
QUS952	23-7/8" x 11" x 7"	21-7/8" x 9" x 6-7/8"	19"	4	14 lbs	WUS952	4	DUS952	4	-	-
QUS953	23-7/8" x 11" x 10"	21-1/2" x 8-7/8" x 9-3/4"	18-3/4"	4	18 lbs	WUS953/973	4	DUS953	4	-	-
QUS954	23-7/8" x 16-1/2" x 11"	21-7/8" x 14-1/4" x 10-3/4"	18-3/4"	1	7 lbs	WUS954/974	1	DUS954	1	AL-23	24
QUS964MOB*	23-7/8" x 16-1/2" x 11"	21-7/8" x 14-1/4" x 10-3/4"	18-3/4"	1	9 lbs	WUS954/974	1	DUS954	1	AL-23	24
QUS955	23-7/8" x 18-1/4" x 12"	21-1/2" x 16" x 11-3/4"	17-3/4"	1	8 lbs	WUS955/975	1	DUS955	1	AL-23	24
QUS965MOB*	23-7/8" x 18-1/4" x 12"	21-1/2" x 16" x 11-3/4"	17-3/4"	1	10 lbs	WUS955/975	1	DUS955	1	AL-23	24
QUS957	23-7/8" x 22-1/2" x 12"	21-1/8" x 20-1/2" x 11-3/8"	18"	1	8 lbs	WUS957	1	DUS957 CRDUS957	1	AL-23	24
QUS967MOB*	23-7/8" x 22-1/2" x 12"	21-1/8" x 20-1/2" x 11-3/8"	18"	1	10 lbs	WUS957	1	DUS957 CRDUS957	1	AL-23	24

*With caster, overall height for mobile container will be increased by 3". To order a full carton add **CS** suffix to Model No. QUS950BLCS. Note: Bins must be ordered in carton quantities only.



HULK 24" Container Wire Shelving Systems - Complete Packages

Up to 800 lb. LOAD CAPACITY PER SHELF



WR8-950
24"W x 36"L x 74"H
8 shelves and 28 QUS950
23-7/8"L x 8-1/4"W x 7"H bins



WR7-951
24"W x 36"L x 74"H
7 shelves and 24 QUS951
23-7/8"L x 8-1/4"W x 9"H bins



WR8-952
24"W x 36"L x 74"H
8 shelves and 21 QUS952
23-7/8"L x 11"W x 7"H bins



WR6-953
24"W x 36"L x 74"H
6 shelves and 15 QUS953
23-7/8"L x 11"W x 10"H bins



WR6-954
24"W x 36"L x 74"H
6 shelves and 10 QUS954
23-7/8"L x 16-1/2"W x 11"H bins



WR5-955
24"W x 42"L x 74"H
5 shelves and 8 QUS955
23-7/8"L x 18-1/4"W x 12"H bins



WR6-957
24"W x 48"L x 74"H
6 shelves and 10 QUS957
23-7/8"L x 22-1/2"W x 12"H bins



WR7-20-MIX
24"W x 36"L x 74"H
7 shelves and 8 QUS950
23-7/8"L x 8-1/4"W x 7"H bins
and 3 QUS952
23-7/8"L x 11"W x 7"H bins
and 4 QUS951
23-7/8"L x 8-1/4"W x 9"H bins
and 3 QUS953
23-7/8"L x 11"W x 10"H bins
and 2 QUS954 bins
23-7/8"L x 16-1/2"W x 11"H bins



MOBILIZE YOUR WIRE SHELVING

DB - Donut Bumper
Non-marking donut bumper used to protect walls and help cushion impact.

WR-00H (Mobile Kit)
Set of four swivel thermoplastic resin 5" x 1-1/4" casters, two with brakes. Can be used with all units shown. Up to 1,200 lb. load capacity.



HULK
containers

Bins available in: ● Blue ● Red ● Yellow ● Clear (One color per unit)



14 SIZES AND 3 COLORS AVAILABLE

Up to 150 lb.
STACK CAPACITY
PER BIN

HEAVY-DUTY

QUS974

HULK
containers

QUS973



QUS976

QUS975



QUS970



29-7/8" L

ADHESIVE CLEAR LABEL
HOLDER AND INSERTS

AL-23

2" x 3-1/2"

(Fits bins 12"H and shorter)

AL-35

3" x 5"

(Fits bins 15"H and taller)

Package of 24
(Sold separately)



QUS997

35-7/8" L

REAR LARGE
HANDLE

Molded onto back of containers makes them easy to carry!



CLEAR PLASTIC
WINDOW FRONT

Increases bin capacity and provides a quick view of the bin contents.
(Sold separately)

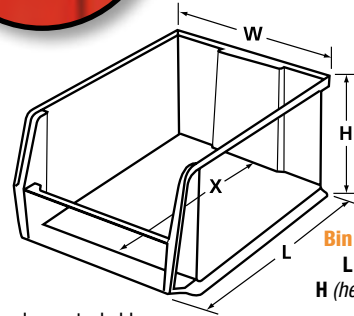

HULK 30" & 36" Containers



Organize and store your large and bulky items with these strong injection molded high impact polypropylene, stackable containers. These extra large stacking containers offer a generous 2-1/2 - 3 feet in length to store your larger items. These huge stack bins are ideal for heavy-duty, extra deep shelving and are available in a variety of widths and heights. Heavy-duty front, back and side grips allow for easy handling. Wide stacking ledge and anti-slide lock keep stacked bins steady and prevent forward shifting. Waterproof bins are corrosion-free. Bins are autoclavable up to 250°F and are resistant to extreme cold.

Available in: ● Blue ● Red ● Yellow

MODEL NO.	OUTSIDE DIMENSIONS L" x W" x H"	INSIDE DIMENSIONS L" x W" x H"	X"	CTN QTY	CTN WGT	CLEAR WINDOW	CTN QTY	CTN DIVIDER	CTN QTY
HULK 30" Containers									
QUS970	29-7/8" x 8-1/4" x 7"	27-7/8" x 6-1/4" x 6-3/4"	25"	6	23 lbs	WUS950/970	6	DUS970	6
QUS973	29-7/8" x 11" x 10"	27-7/8" x 8-7/8" x 9-5/8"	24-3/4"	4	22 lbs	WUS953/973	4	DUS973	4
QUS974	29-7/8" x 16-1/2" x 11"	27-5/8" x 14-1/4" x 10-5/8"	24-3/4"	1	8 lbs	WUS954/974	1	DUS974	1
QUS984MOB*	29-7/8" x 16-1/2" x 11"	27-5/8" x 14-1/4" x 10-5/8"	24-3/4"	1	10 lbs	WUS954/974	1	DUS974	1
QUS975	29-7/8" x 18-1/4" x 12"	27-1/2" x 16" x 11-3/4"	23-3/4"	1	9 lbs	WUS955/975	1	DUS975	1
QUS985MOB*	29-7/8" x 18-1/4" x 12"	27-1/2" x 16" x 11-3/4"	23-3/4"	1	11 lbs	WUS955/975	1	DUS975	1
QUS976	29-7/8" x 16-1/2" x 15"	27-3/8" x 14" x 14-3/4"	23-1/2"	1	10 lbs	WUS976	1	DUS976	1
QUS986MOB*	29-7/8" x 16-1/2" x 15"	27-3/8" x 14" x 14-3/4"	23-1/2"	1	12 lbs	WUS976	1	DUS976	1
HULK 36" Containers									
QUS993	35-7/8" x 16-1/2" x 17-1/2"	33-1/8" x 14" x 17-1/4"	28-1/4"	1	14 lbs	-	-	DUS993	1
QUS994MOB*	35-7/8" x 16-1/2" x 17-1/2"	33-1/8" x 14" x 17-1/4"	28-1/4"	1	16 lbs	-	-	DUS993	1
QUS995	35-7/8" x 19-7/8" x 17-1/2"	33-1/8" x 17-3/8" x 17-1/4"	28-1/4"	1	15 lbs	-	-	DUS995	1
QUS996MOB*	35-7/8" x 19-7/8" x 17-1/2"	33-1/8" x 17-3/8" x 17-1/4"	28-1/4"	1	17 lbs	-	-	DUS995	1
QUS997	35-7/8" x 23-7/8" x 17-1/2"	33-1/4" x 21-3/8" x 17-1/4"	28-1/4"	1	18 lbs	-	-	DUS997	1
QUS998MOB*	35-7/8" x 23-7/8" x 17-1/2"	33-1/4" x 21-3/8" x 17-1/4"	28-1/4"	1	20 lbs	-	-	DUS997	1

*With caster, overall height for mobile container will be increased by 3". To order a full carton add CS suffix to Model No. QUS970BLCS. Note: Bins must be ordered in carton quantities only.





HULK 30" Container Wire Shelving Systems - Complete Packages

Up to 700 lb. LOAD CAPACITY PER SHELF



WR8-970
30"W x 36"L x 74"H
8 shelves and 28 QUS970
29-7/8"L x 8-1/4"W x 7"H bins



WR6-973
30"W x 36"L x 74"H
6 shelves and 15 QUS973
29-7/8"L x 11"W x 10"H bins



WR6-974
30"W x 36"L x 74"H
6 shelves and 10 QUS974
29-7/8"L x 16-1/2"W x 11"H bins



WR6-973974
30"W x 36"L x 74"H
6 shelves and 9 QUS973
and 4 QUS974
29-7/8"L x 11"W x 10"H bins
and 4 QUS974
29-7/8"L x 16-1/2"W x 11"H bins

HULK
containers

**QUANTUM CHROME
WIRE SHELVING
SYSTEMS COMPLETE
WITH BINS**



WR5-975
30"W x 42"L x 74"H
5 shelves and 8 QUS975
29-7/8"L x 18-1/4"W x 12"H bins



MOBILIZE YOUR WIRE SHELVING

DB - Donut Bumper
Non-marking donut bumper used to protect walls and help cushion impact.

WR-00H (Mobile Kit)
Set of four swivel thermoplastic resin 5" x 1-1/4" casters, two with brakes. Can be used with all units shown. 1,200 lb. load capacity.

Bins available in: ● Blue ● Red ● Yellow (One color per unit)



HULK 36" Container Wire Shelving Systems - Complete Packages



WR5-993
36"W x 36"L x 86"H
5 shelves and 8 QUS993
35-7/8"L x 16-1/2"W x 17-1/2"H bins



WR5-995
36"W x 48"L x 86"H
5 shelves and 8 QUS995
35-7/8"L x 19-7/8"W x 17-1/2"H bins

HULK
containers

ON
SHELVING

SIZE
DOES MATTER

Up to 600 lb.
STACK CAPACITY
PER SHELF



MOBILIZE YOUR WIRE SHELVING

DB - Donut Bumper
Non-marking donut bumper used to protect walls and help cushion impact.

WR-00H (Mobile Kit)
Set of four swivel thermoplastic resin 5" x 1-1/4" casters, two with brakes. Can be used with all units shown. Up to 1,200 lb. load capacity.



WR5-997
36"W x 60"L x 86"H
5 shelves and 8 QUS997
35-7/8"L x 23-7/8"W x 17-1/2"H bins

QUANTUM CHROME
WIRE SHELVING
SYSTEMS COMPLETE
WITH BINS

Bins available in: ● Blue ● Red ● Yellow (One color per unit)



Collapsible Bulk Box



Quantum's Collapsible Bulk Box provides an efficient approach to large volume or large part material handling, storage and transport. Used for heavy loads, components and even food products, these reusable and returnable containers allow you to ship, handle, pick, store and distribute your products while increasing productivity and profitability. Quantum's Collapsible Bulk Box comes in a standard pallet size footprint measuring 48"L x 45"W. It can be collapsed down to a fraction of its full height in seconds. Bulk containers stack perfectly loaded or when folded down to minimize storage space. They are designed to make the shipping of your products faster, safer and less costly while providing greater protection. Two access drop doors are able to lie flush against the container allowing easy loading and unloading. Manufactured from High Density Polyethylene, this tough container provides superior protection for products while being stored or in transit. Welded base provides greater strength while the reinforced fork openings provide easy lifting. Can withstand temperatures between -20° and 250°F. Optional lid available to cover contents inside (*Model No: LID-4845*).

HANDLE, SHIP, DISTRIBUTE, REUSE



(Lid **LID-4845** Sold separately)

Fully expanded Bulk Box measures
48"L x 45"W x 34"H



Two access drop doors allows easy loading and unloading



Easy opening and collapsing of Bulk Box's side walls



Collapses to 12-3/4"; a fraction of it's full height



QBB-4845-34

PERFORMANCE FEATURES:

- Plastic, ergonomic latches for opening and collapsing
- Superior strength with low tare weight
- High return ratio: return 3 collapsed boxes for each bulk box distributed
- Up to 1,800 lb. load capacity for standard usage
- Large, flat labeling area on all four sides

Available in: ● Black

MODEL NO.	L (INCH/MM)	W (INCH/MM)	H (INCH/MM)
QBB-4845-34			
External	48.00 /1219.2	45.00 /1143.0	33.9 /861.1
Internal	44.50 /1130.3	41.50 /1054.1	28.2 /716.0
Usable Interior Height (<i>Fill line</i>)	-	-	27.10 /688.3
Access Drop Door - Cut Out	-	30.00 /762.0	15.95 /405.1
Collapsed Height	-	-	12.76 /324.0
Nested Height	-	-	11.77 /299.0
Stack of 9/Collapsed (<i>Trailer</i>)	-	-	106.93 /2716.1
Fork Tunnel - 48" Side	-	11.00 /279.4	3.40 /86.4
Fork Tunnel - 45" Side	-	11.38 /288.9	3.40 /86.4
Ship wgt. - 118 lbs			



PLASTIC STORAGE RACKBIN 42" CONTAINERS

RackBin 42" Containers



- These extra large bins offer a generous 42" (3-1/2 Feet) in length to store your larger items
- 42" length ensures no wasted space on 42" deep pallet rack
- Heavy-duty front, back and side grips allow for easy handling
- Wide stacking ledge and anti-slide lock keep stack bins steady and prevent forward shifting
- Have eight 1/4" drill hole pattern on bottom of bin for easy hole insertion for drainage and air circulation if needed
- Waterproof bins are corrosion free

Up to 180 lb.
STACK CAPACITY PER BIN

Available in: ● Blue ● Gray

MODEL NO.	OUTSIDE DIMENSIONS L" x W" x H"	INSIDE DIMENSIONS L" x W" x H"	X"	CTN QTY	CTN WGT
QRB166	41-7/8" x 16-1/2" x 17-1/2"	40-1/8" x 14" x 16-1/2"	35"	1	16 lbs
QRB176MOB*	41-7/8" x 16-1/2" x 17-1/2"	40-1/8" x 14" x 16-1/2"	35"	1	18 lbs
QRB206	41-7/8" x 19-7/8" x 17-1/2"	40-1/8" x 17-3/8" x 16-1/2"	35"	1	17 lbs
QRB216MOB*	41-7/8" x 19-7/8" x 17-1/2"	40-1/8" x 17-3/8" x 16-1/2"	35"	1	19 lbs
QRB246	41-7/8" x 23-7/8" x 17-1/2"	40-1/8" x 21-1/2" x 16-1/2"	35"	1	19 lbs
QRB256MOB*	41-7/8" x 23-7/8" x 17-1/2"	40-1/8" x 21-1/2" x 16-1/2"	35"	1	21 lbs

*With caster, overall height for mobile container will be increased by 3"



RACKBIN^{42"}



AL-35

3" x 5"

Adhesive clear label holder and inserts. Package of 24 (Sold separately)

Smooth label area

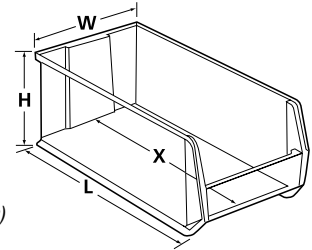

Bin Dimensions Guide
L (length) W (width)
H (height) X (inside length)

6 SIZES AND 2 COLORS AVAILABLE



**THE FIRST AND ONLY BIN DESIGNED
SPECIFICALLY TO FIT PALLET RACK**



RackBin 42" Container Wire Shelving Systems - Complete Packages



WRA86-2142C-206



WRA86-2136C-166



**COMPLETE PACKAGES
WITH BINS**

Bins available in: ● Blue ● Gray (One color per unit)

MODEL NO.	DIMENSIONS W" x L" x H"	NO. OF CONTAINERS	CONTAINER SIZE L" x W" x H"	SHIP WGT
WRA86-2136C-166	42" x 36" x 86"	8 QRB166	41-7/8" x 16-1/2" x 17-1/2"	272 lbs
WRA86-2142C-206	42" x 42" x 86"	8 QRB206	41-7/8" x 19-7/8" x 17-1/2"	290 lbs
WRA86-2154C-166	42" x 54" x 86"	12 QRB166	41-7/8" x 16-1/2" x 17-1/2"	386 lbs



5 SIZES AND 6 COLORS AVAILABLE

CLEAR BINS
AVAILABLE VIEW

QGH600



AL-23

2" x 3-1/2"
Adhesive clear label holder and inserts.
Package of 24
(Sold separately)



QGH700



Curved lip and corners provide added strength

Large label holder allows for quick part identification
LTR-700
Clear label holders and laser label inserts slide into front label slot of all bins.
(Sold in packages of 25)

QGH800



Smooth label area

Large and comfortable side grip handles allow for easy carrying and handling



Ribs on side of bin provide added stability when stacked

Up to 150 lb.
STACK CAPACITY
PER BIN

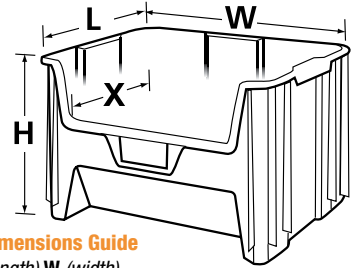

Bin Dimensions Guide
L (length) W (width)
H (height) X (inside length)

Giant Stack Containers



Multipurpose, wide open hopper front provides easy access for large part storage. Ideal for multiple applications in recycling, storing parts and components. This bin will stack up to 6 bins high creating a sturdy, tall storage system. Bins are injection molded from high density polypropylene, easy to clean, resist corrosion and are impervious to most chemicals. Large label holder allows for quick identification. Optional clear window front increases storage capacity and allows for quick identification of parts. Six 1/4" drill hole pattern on bottom of bin allow for easy hole insertion for drainage and air circulation.

QGH700 available in: ● Blue ● Ivory ● Red ● Black ● Gray ● Clear

QGH600 and QGH800 available in: ● Blue ● Red ● Gray ● Clear

MODEL NO.	OUTSIDE DIMENSIONS L" x W" x H"	INSIDE DIMENSIONS L" x W" x H"	X"	CAP CU FT	CTN QTY	CTN WGT	WINDOW	CTN QTY
QGH600	17-1/2" x 10-7/8" x 12-1/2"	15-5/8" x 8" x 12-1/4"	13-1/2"	0.98	4	12 lbs	WGH600	4
QGH700*	15-1/4" x 19-7/8" x 12-7/16"	13-5/8" x 17-1/2" x 12-1/4"	11-1/2"	1.7	3	13 lbs	WGH700	3
QGH800	17-1/2" x 16-1/2" x 12-1/2"	15-5/8" x 13-3/4" x 12-1/4"	13-1/2"	1.6	2	8 lbs	WGH800	2

To order a full carton add **CS** suffix to Model No. QGH600**LCS**. Note: Bins must be ordered in carton quantities only.

PERFORMANCE FEATURES:

- Extra thick side walls with reinforced ribs designed for strength, allowing for up to 150 lb. stack capacity per bin
- Large side grip handles
- Stacks 6 bins high
- Six 1/4" drill hole pattern on bottom of bin allows for easy hole insertion for drainage

Mobile Giant Stack Containers



- Ideal for transport of heavy and bulky parts
- Container comes with 4 swivel, 3" polyurethane casters, all with brakes, allowing for up to 250 lb. mobile load capacity
- Containers can stack with casters in place

QGH705MOB



QGH805MOB



QGH705MOB available in: ● Blue ● Ivory ● Red ● Black ● Gray ● Clear

QGH805MOB available in: ● Blue ● Red ● Gray ● Clear

MODEL NO.	OUTSIDE DIMENSIONS L" x W" x H"	INSIDE DIMENSIONS L" x W" x H"	X"	CAP CU FT	CTN QTY	CTN WGT	WINDOW	CTN QTY
QGH705MOB*	15-1/4" x 19-7/8" x 12-7/16"	13-5/8" x 17-1/2" x 12-1/4"	11-1/2"	1.7	3	22 lbs	WGH700	3
QGH805MOB*	17-1/2" x 16-1/2" x 12-1/2"	15-5/8" x 13-3/4" x 12-1/4"	13-1/2"	1.6	2	17 lbs	WGH800	2

*With caster, overall height for mobile container will be increased by 3". To order a full carton add **CS** suffix to Model No. QGH705MOB**LCS**. Note: Bins must be ordered in carton quantities only.



CLEAR PLASTIC WINDOW FRONT

Increases bin capacity and provides a quick view of the bin contents.
(Sold separately)



Giant Stack Container Wire Shelving Systems - Complete Packages



WR5-600
18"W x 36"L x 74"H
5 shelves and 12 QGH600
17-1/2"L x 10-7/8"W x 12-1/2"H bins

**COMPLETE
PACKAGES
WITH BINS**



WR5-600800
18"W x 36"L x 74"H
5 shelves and 6 QGH600 17-1/2"L x 10-7/8"W x 12-1/2"H bins and
4 QGH800 17-1/2"L x 16-1/2"W x 12-1/2"H bins

**Up to 800 lb.
STACK CAPACITY
PER SHELF**



WR5-800
18"W x 36"L x 74"H
5 shelves and 8 QGH800
17-1/2"L x 16-1/2"W x 12-1/2"H bins



MOBILIZE YOUR WIRE SHELVING

DB - Donut Bumper
Non-marking donut bumper used to protect walls and help cushion impact.

WR-00H (Mobile Kit)
Set of four swivel thermoplastic resin 5" x 1-1/4" casters, two with brakes. Can be used with all units shown. Up to 1,200 lb. load capacity.



WR5-700
18"W x 42"L x 74"H
5 shelves and 8 QGH700
15-1/4"L x 19-7/8"W x 12-7/16"H bins

QGH700 available in: ● Blue ● Ivory ● Red ● Black ● Gray ● Clear

QGH600 and QGH800 available in: ● Blue ● Red ● Gray ● Clear (One color per unit)



6 SIZES AND 5 COLORS AVAILABLE



MAGNUM

PERFORMANCE FEATURES:

- Available in 6 sizes and 5 colors (Blue, Green, Red, Yellow and Black) for inventory control and color code efficiency
- These heavy-duty containers are injection molded from high density polypropylene and are ideal for storage and transport of large and heavy parts
- Extra heavy, double wall thickness allow containers to stack securely
- Up to 150 lb. stack capacity

MAGNUM Bins - Super Strong and Durable



Heavy-duty, extra strong injection molded, high density polypropylene bins are ideal for transportation and storage of large and heavy parts. Open hopper front allows immediate access and visibility. Ribbed reinforced walls ensure extra strength. Double wall thickness with preformed lip allows bin to interlock and provides up to 150 lb. stack capacity. Transport these bins easily with rear molded handle. Molded in label slot. Impervious to most solvents, corrosion, rust and rot resistant. Resists temperatures from -40°F to 250°F. Optional window front maximizes storage and prevents spillage. Optional dividers maximize flexibility and keeps contents organized.

Available in: ● Blue ● Green ● Red ● Yellow ● Black

MODEL NO.	OUTSIDE DIMENSIONS L" x W" x H"	INSIDE DIMENSIONS L" x W" x H"	X"	CTN QTY	CTN WGT	DIVIDERS	CTN QTY	WINDOW	CTN QTY
QMS531	19-3/4" x 12-3/8" x 5-7/8"	17" x 11" x 5"	17"	6	19 lbs	DMS531	6	WMS531	6
QMS532	19-3/4" x 12-3/8" x 7-7/8"	16-3/4" x 11" x 7-1/4"	16-3/4"	6	23 lbs	DMS532	6	WMS532	6
QMS533	19-3/4" x 12-3/8" x 11-7/8"	16-5/8" x 10-1/4" x 11-1/8"	16-5/8"	3	15 lbs	DMS533	3	WMS533	3
QMS543	19-3/4" x 18-3/8" x 11-7/8"	16-5/8" x 16-3/4" x 11"	16-5/8"	1	8 lbs	DMS543	1	WMS543	1
QMS743*	29" x 18-3/8" x 11-7/8"	25-1/2" x 16-3/4" x 11"	23"	1	10 lbs	-	-	-	-
QMS843MOB*	29" x 18-3/8" x 14-7/8"	25-1/2" x 16-3/4" x 11"	23"	1	12 lbs	-	-	-	-

*Includes heavy-duty spread bar for extra strength and support. To order a full carton add CS suffix to Model No. QMS531BLCS. Note: Bins must be ordered in carton quantities only.



LTR-1754
Clear Label Holder and Insert
Fits all Magnum bin sizes.
Package of 25.



Up to 150 lb.
STACK CAPACITY
PER BIN

COMFORT HANDLE
for easy gripping and handling



QMS743 and QMS843MOB
Includes heavy-duty spread bar for extra strength and support



ATTACHED PULL RING
allows dolly to be pulled with ease

Polymer Dolly

DLY-3018 is 30"L x 18"W with padded rubber trim, available in Blue. Set of four 4" x 1-1/4" non-marking swivel poly casters. Both dollies have up to 1,000 lb. load capacity.

MODEL NO.	DESCRIPTION	CTN WGT
DLY-3018	Dolly with Padded Rubber Trim	19 lbs
HANDLE-DLY	32" Dolly Pull Rod with Handle	2 lbs

Bins sold separately

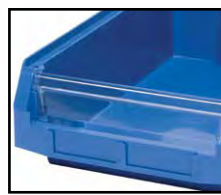

CLEAR WINDOW FRONT
Increases bin capacity and provides a quick view of the bin contents. (Optional)



MAGNUM BIN
Shown with optional divider

Mobile MAGNUM Bins

- Bin comes with 4 swivel 3" polyurethane casters, all with brakes, allowing for up to 250 lb. mobile capacity
- Bins can stack on each other with casters in place
- QMS843MOB includes heavy-duty spread bar



MAGNUM Bin Wire Shelving Systems - Complete Packages



WR9-531
18"W x 42"L x 74"H
9 shelves and 24 QMS531
19-3/4"L x 12-3/8"W x 5-7/8"H bins



WR7-532
18"W x 42"L x 74"H
7 shelves and 18 QMS532
19-3/4"L x 12-3/8"W x 7-7/8"H bins



WR5-533
18"W x 42"L x 74"H
5 shelves and 12 QMS533
19-3/4"L x 12-3/8"W x 11-7/8"H bins



WR5-543
18"W x 42"L x 74"H
5 shelves and 8 QMS543
19-3/4"L x 18-3/8"W x 11-7/8"H bins

Up to 800 lb.
STACK CAPACITY PER SHELF

MAGNUM

**COMPLETE
PACKAGES
WITH BINS**



MOBILIZE YOUR WIRE SHELVING

DB - Donut Bumper
Non-marking donut bumper used to protect walls and help cushion impact.

WR-00H (Mobile Kit)
Set of four swivel thermoplastic resin 5" x 1-1/4" casters, two with brakes. Can be used with all units shown. Up to 1,200 lb. load capacity.



WR6-13-MIX
18"W x 42"L x 74"H
6 shelves and 4 QMS543 19-3/4"L x 18-3/8"W x 11-7/8"H bins
3 QMS533 19-3/4"L x 12-3/8"W x 11-7/8"H bins
3 QMS532 19-3/4"L x 12-3/8"W x 7-7/8"H bins
3 QMS531 19-3/4"L x 12-3/8"W x 5-7/8"H bins

Bins available in: ● Blue ● Green ● Red ● Yellow ● Black (One color per unit)



15 SIZES AND 7 COLORS AVAILABLE

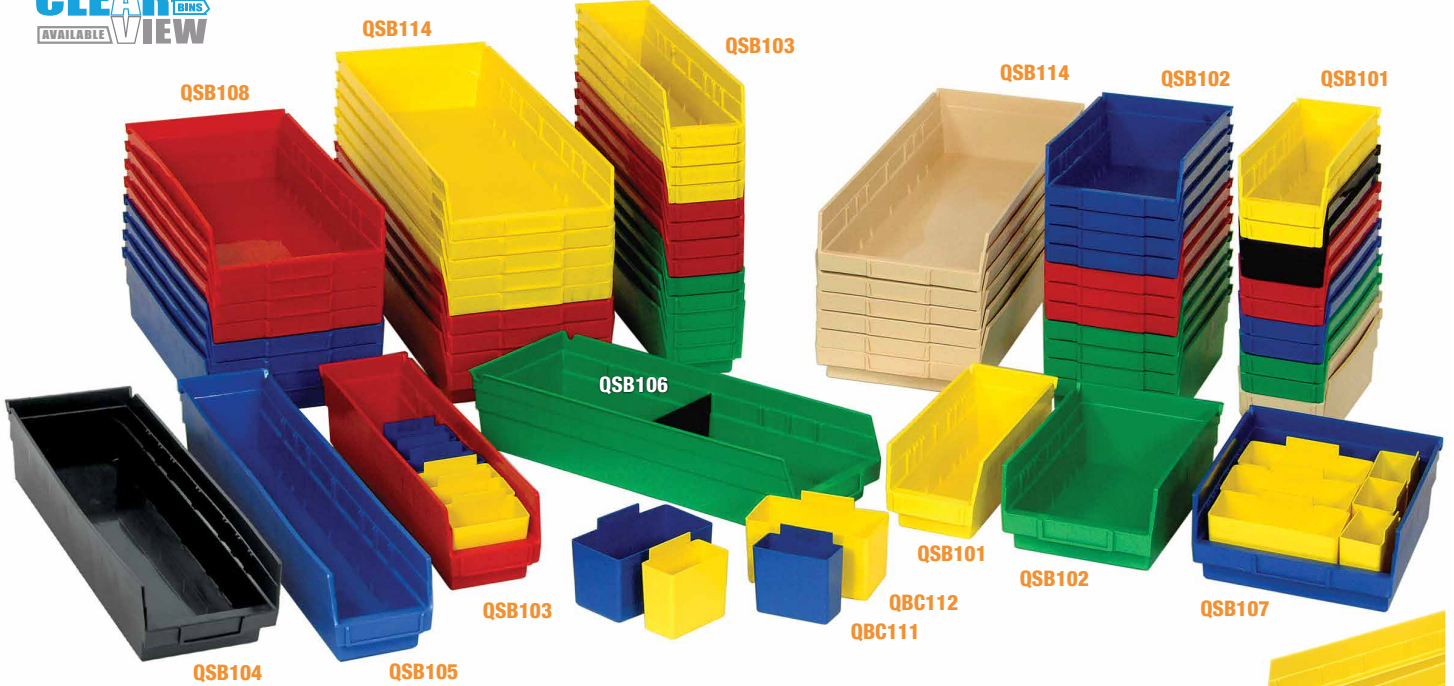

LOW COST, LONG LASTING, UNBREAKABLE, REUSABLE 4" HIGH BINS

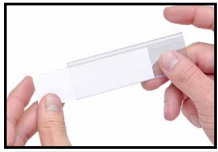

LTR-0813
Clear Label Holder and Insert
Clear label holders and laser label inserts. Package of 25. Label holders fit all bins (except QSB100).

Divider Label Tab

Divider Label Tabs attach to existing dividers enabling sections of bin to be labeled. Tabs improve the visibility of bin labels and scanning of barcodes. Package of 6.



DLT-6

Extended Label Holders - Simplify Identification



Optional extended label holders are designed for larger bar code scanning or just larger labels. Label holders fit all Shelf Bins (except QSB100).

MODEL NO.	DESCRIPTION	DIMENSIONS W" x H"	CTN QTY
ELH410	10° Angle	4" x 2-1/4"	24
ELH445	45° Angle	4" x 2-1/4"	24

10° Angle
45° Angle

Economy 4" Shelf Bins



Quantum's tough, durable, high density Economy Shelf Bins are the industry standard for quality. These durable polypropylene bins feature a molded-in label holder, built-in rear hanglock which allows bins to tilt out for complete access when on shelving. A wide hopper front allows complete access to the contents of the bin. Edges are reinforced for added strength. They are designed for 12", 18" and 24" deep shelf units, racks or standard shelving. Bins are impervious to most chemicals.

Available in: ● Blue ● Green ● Ivory ● Red ● Yellow ● Black ● Clear

MODEL NO.	OUTSIDE DIMENSIONS L" x W" x H"	INSIDE DIMENSIONS L" x W" x H"	CTN QTY	CTN WGT	DIVIDER	CTN QTY	NO. OF BIN CUPS PER BIN
							QBC111 QBC112
QSB100	11-5/8" x 2-3/4" x 4"	10-1/4" x 1-5/8" x 4"	36	10 lbs	-	-	3 0
QSB101	11-5/8" x 4-1/8" x 4"	10-1/4" x 3" x 4"	36	13 lbs	DSB101	50	6 2
QSB102	11-5/8" x 6-5/8" x 4"	10-1/4" x 5-1/2" x 4"	30	15 lbs	DSB102	50	9 4
QSB107	11-5/8" x 8-3/8" x 4"	10-1/4" x 7-1/8" x 4"	20	12 lbs	DSB107	50	12 4
QSB109	11-5/8" x 11-1/8" x 4"	10-1/4" x 10" x 4"	8	7 lbs	DSB109	50	18 6
QSB118 NEW	11-5/8" x 16-1/2" x 4"	10" x 15" x 4"	6	7 lbs	DSB118/122 LDSB118	24 6	27 8
QSB103	17-7/8" x 4-1/8" x 4"	16-1/2" x 3" x 4"	20	11 lbs	DSB103	50	9 3
QSB104	17-7/8" x 6-5/8" x 4"	16-1/2" x 5-1/2" x 4"	20	15 lbs	DSB104	50	15 6
QSB108	17-7/8" x 8-3/8" x 4"	16-1/2" x 7-1/8" x 4"	10	11 lbs	DSB108	50	19 6
QSB110	17-7/8" x 11-1/8" x 4"	16-1/2" x 10" x 4"	8	10 lbs	DSB110	50	29 8
QSB122 NEW	17-7/8" x 16-1/2" x 4"	16" x 15" x 4"	6	10 lbs	DSB118/122 LDSB122	24 6	41 15
QSB105	23-5/8" x 4-1/8" x 4"	22-1/8" x 3" x 4"	16	13 lbs	DSB105	50	13 4
QSB106	23-5/8" x 6-5/8" x 4"	22-1/8" x 5-1/2" x 4"	8	9 lbs	DSB106	50	21 8
QSB114	23-5/8" x 8-3/8" x 4"	22-1/8" x 7-1/8" x 4"	6	8 lbs	DSB114	50	24 8
QSB116	23-5/8" x 11-1/8" x 4"	22-1/8" x 10" x 4"	6	9 lbs	DSB116	50	35 16

To order a full carton add **CS** suffix to Model No. QSB100BLC. Note: Bins must be ordered in carton quantities only.



Dividers and Bin Cups



Optional dividers fit snugly, horizontally across bins and are uniquely designed to allow for easy part labeling via individual label slots. All bins can accommodate up to 7 dividers.

Bin cups have a raised, slotted label holder for easy parts identification. The entire bin cup may be removed for easy part retrieval. Available in 2 sizes and 2 colors.

Available in: ● Blue ● Yellow

MODEL NO.	OUTSIDE DIMENSIONS L" x W" x H"	CTN QTY	CTN WGT
QBC111	3-1/4" x 1-3/4" x 3"	48	4 lbs
QBC112	5-1/8" x 2-3/4" x 3"	48	7 lbs



WR12-101

COMPLETE PACKAGES WITH BINS



Up to **800 lb.**
STACK CAPACITY
PER SHELF



MOBILIZE YOUR WIRE SHELVING

DB - Donut Bumper
Non-marking donut bumper used to protect walls and help cushion impact.

WR-00H (Mobile Kit)*
Set of four swivel thermoplastic resin 5" x 1-1/4" casters, two with brakes. Up to 1,200 lb. load capacity.
**Mobile kits recommended only for shelves 18" and deeper.*



WR12-102



WR12-107

Economy 4" Shelf Bin Wire Shelving Systems - Complete Packages

Bins available in: ● Blue ● Green ● Ivory ● Red ● Yellow
● Black ● Clear (One color per unit)

MODEL NO.	NO. OF BINS	BIN DIMENSIONS L" x W" x H"	SHIP WGT
12"W x 36"L x 74"H - 12 Shelf Systems			
WR12-101	88 QSB101	11-5/8" x 4-1/8" x 4"	120 lbs
WR12-102	55 QSB102	11-5/8" x 6-5/8" x 4"	116 lbs
WR12-107	44 QSB107	11-5/8" x 8-3/8" x 4"	117 lbs
WR12-109	33 QSB109	11-5/8" x 11-1/8" x 4"	119 lbs
18"W x 36"L x 74"H - 12 Shelf Systems			
WR12-103	88 QSB103	17-7/8" x 4-1/8" x 4"	176 lbs
WR12-104	55 QSB104	17-7/8" x 6-5/8" x 4"	165 lbs
WR12-108	44 QSB108	17-7/8" x 8-3/8" x 4"	170 lbs
WR12-110	33 QSB110	17-7/8" x 11-1/8" x 4"	168 lbs
24"W x 36"L x 74"H - 12 Shelf Systems			
WR12-105	88 QSB105	23-5/8" x 4-1/8" x 4"	228 lbs
WR12-106	55 QSB106	23-5/8" x 6-5/8" x 4"	218 lbs
WR12-114	44 QSB114	23-5/8" x 8-3/8" x 4"	222 lbs
WR12-116	33 QSB116	23-5/8" x 11-1/8" x 4"	206 lbs

Economy 4" Complete Bin Center

Complete bin systems are available with 4 different size bin options on a 12"W x 36"L x 36"H unit. This all-purpose bin center is an economical high density storage system that provides easy visibility to stored contents.

- Easy boltless assembly
- Wire allows air to circulate as well as provides ideal product visibility
- Durable chrome finish ensures years of heavy-duty dependability and service

Bins available in: ● Blue ● Green ● Ivory ● Red ● Yellow
● Black ● Clear (One color per unit)

MODEL NO.	NO. OF BINS	BIN DIMENSIONS L" x W" x H"	SHIP WGT
12"W x 36"L x 36"H - 6 Shelf Systems			
WR6-36-1236-101	40 QSB101	11-5/8" x 4-1/8" x 4"	63 lbs
WR6-36-1236-102	25 QSB102	11-5/8" x 6-5/8" x 4"	50 lbs
WR6-36-1236-107	20 QSB107	11-5/8" x 8-3/8" x 4"	62 lbs
WR6-36-1236-109	15 QSB109	11-5/8" x 11-1/8" x 4"	64 lbs



WR6-36-1236-102



High Density Wire Shelving Systems



- Wire Storage Systems with bins available in 48", 60" and 72" lengths
- All units in chart below utilize 74" posts and include 12 shelves
- Non-marring thermoplastic resin caster kit **WR-00H** (sold separately)



WR74-2448-66106



WR74-2448-66106
Shown with optional Mobile Kit



MOBILIZE YOUR WIRE SHELVING

DB - Donut Bumper
Non-marking donut bumper used to protect walls and help cushion impact.

WR-00H (Mobile Kit)*
Set of four swivel thermoplastic resin 5" x 1-1/4" casters, two with brakes. Up to 1,200 lb. load capacity.
*Mobile kits recommended only for shelves 18" and deeper.

Up to 600-800 lb.
LOAD CAPACITY PER SHELF

Bins available in: ● Blue ● Green ● Ivory ● Red ● Yellow ● Black ● Clear (One color per unit)

HIGH DENSITY WIRE SYSTEMS									
48" L SYSTEMS			60" L SYSTEMS			72" L SYSTEMS			
BIN DIMENSIONS L" x W" x H"	MODEL NO.	NO. OF BINS	SHIP WGT	MODEL NO.	NO. OF BINS	SHIP WGT	MODEL NO.	NO. OF BINS	SHIP WGT
12"W x 48"L - Systems									
11-5/8" x 4-1/8" x 4"	WR74-1248-110101	110 QSB101	152 lbs	WR74-1260-143101	143 QSB101	208 lbs	WR74-1272-176101	176 QSB101	248 lbs
11-5/8" x 4-1/8" x 4"	WR74-1248-101102	55 QSB101	148 lbs	WR74-1260-101102	78 QSB101	213 lbs	WR74-1272-101102	80 QSB101	240 lbs
11-5/8" x 6-5/8" x 4"	WR74-1248-66102	36 QSB102	140 lbs	WR74-1260-88102	40 QSB102	193 lbs	WR74-1272-110102	60 QSB102	230 lbs
11-5/8" x 6-5/8" x 4"	WR74-1248-66102	66 QSB102	140 lbs	WR74-1260-88102	88 QSB102	193 lbs	WR74-1272-110102	110 QSB102	230 lbs
18"W x 48"L - Systems									
17-7/8" x 4-1/8" x 4"	WR74-1848-110103	110 QSB103	168 lbs	WR74-1860-143103	143 QSB103	224 lbs	WR74-1872-176103	176 QSB103	264 lbs
17-7/8" x 4-1/8" x 4"	WR74-1848-103104	55 QSB103	164 lbs	WR74-1860-103104	78 QSB103	229 lbs	WR74-1872-103104	80 QSB103	256 lbs
17-7/8" x 6-5/8" x 4"	WR74-1848-66104	36 QSB104	156 lbs	WR74-1860-88104	40 QSB104	209 lbs	WR74-1872-110104	60 QSB104	246 lbs
17-7/8" x 6-5/8" x 4"	WR74-1848-66104	66 QSB104	156 lbs	WR74-1860-88104	88 QSB104	209 lbs	WR74-1872-110104	110 QSB104	246 lbs
24"W x 48"L - Systems									
23-5/8" x 4-1/8" x 4"	WR74-2448-110105	110 QSB105	180 lbs	WR74-2460-143105	143 QSB105	256 lbs	WR74-2472-176105	176 QSB105	312 lbs
23-5/8" x 4-1/8" x 4"	WR74-2448-105106	55 QSB105	176 lbs	WR74-2460-105106	78 QSB105	261 lbs	WR74-2472-105106	80 QSB105	304 lbs
23-5/8" x 6-5/8" x 4"	WR74-2448-66106	36 QSB106	168 lbs	WR74-2460-88106	40 QSB106	241 lbs	WR74-2472-110106	60 QSB106	294 lbs
23-5/8" x 6-5/8" x 4"	WR74-2448-66106	66 QSB106	168 lbs	WR74-2460-88106	88 QSB106	241 lbs	WR74-2472-110106	110 QSB106	294 lbs

48"L - Up to 800 lb. Capacity/Shelf

60"L - Up to 600 lb. Capacity/Shelf

72"L - Up to 600 lb. Capacity/Shelf



CLEAR BINS
AVAILABLE VIEW

14 SIZES AND 4 COLORS AVAILABLE

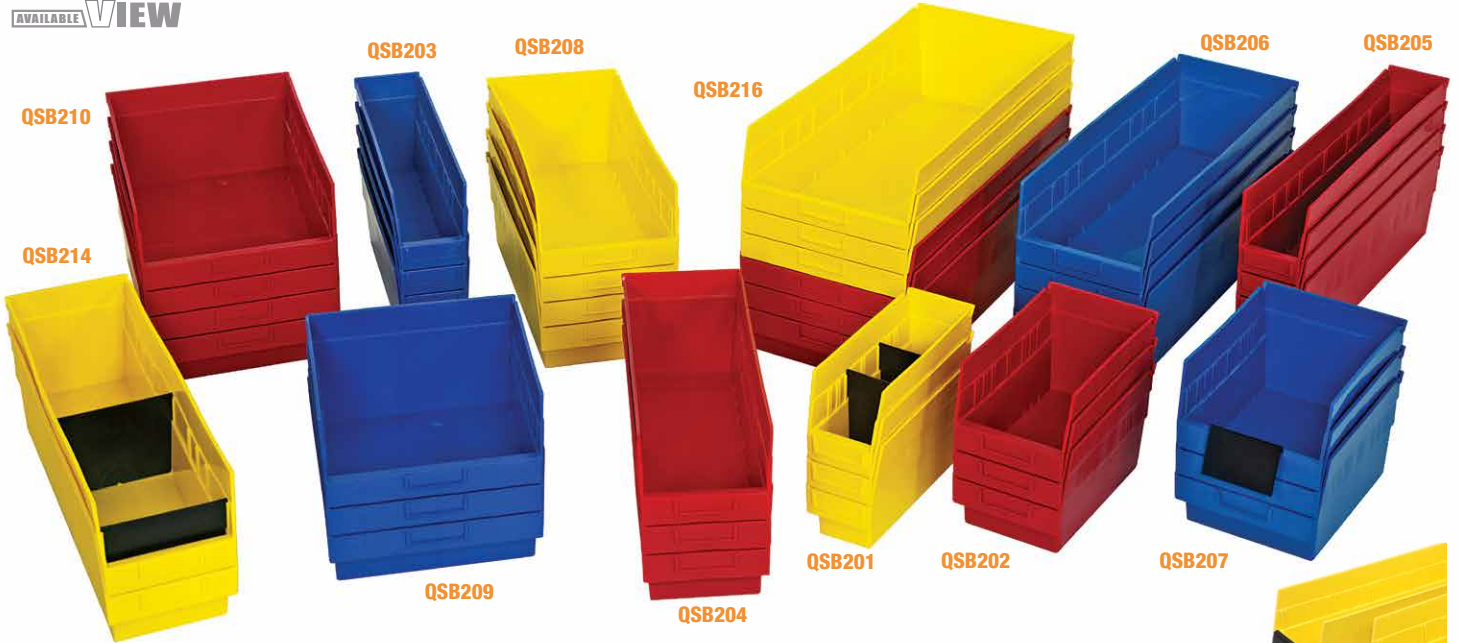

**LOW COST, LONG LASTING, UNBREAKABLE, REUSABLE,
6" HIGH SHELF BINS**

10° Angle

45° Angle



with **68%** more storage capacity over standard 4" shelf bins, Quantum's **STORE-MORE 6"** Shelf Bins are an industry first and now an industry standard

Divider Label Tab

Divider Label Tabs attach to existing dividers enabling sections of bin to be labeled. Tabs improve the visibility of bin labels and scanning of barcodes. Package of 6.



DLT-6

Extended Label Holders - Simplify Identification

Optional extended label holders are designed for larger bar code scanning or just larger labels. Label holders fit all 6" Shelf Bins.

MODEL NO.	DESCRIPTION	DIMENSIONS W" x H"	CTN QTY
ELH410	10° Angle	4" x 2-1/4"	24
ELH445	45° Angle	4" x 2-1/4"	24

LTR-0813 Clear Label Holder and Insert

Clear label holders and laser label inserts. Clear label holders fit all 6" Shelf Bins. Package of 25.



STORE-MORE 6" Shelf Bins



Maximize your storage space with durable, high density polypropylene bins. Quantum's STORE-MORE 6" Shelf Bins are the industry standard for quality. These bins feature a molded-in label holder, built-in rear hang-lock which allows bins to tilt out for complete access when on shelving. A wide hopper front allows complete access to the contents of the bin. Edges are reinforced for added strength. They are designed for 12", 18" and 24" deep shelf units, racks or standard shelving. Optional dividers are a perfect accessory to subdivide and keep parts separated as needed. Bins are waterproof and corrosion-free.

Available in: ● Blue ● Red ● Yellow ● Clear

MODEL NO.	OUTSIDE DIMENSIONS L" x W" x H"	INSIDE DIMENSIONS L" x W" x H"	CTN QTY	CTN WGT	DIVIDER	CTN QTY	NO. OF BIN CUPS PER BIN
							QBC111 QBC112
QSB201	11-5/8" x 4-1/8" x 6"	10-1/6" x 3" x 6"	36	19 lbs	DSB201	50	6 2
QSB202	11-5/8" x 6-5/8" x 6"	10-1/6" x 5-1/2" x 6"	30	20 lbs	DSB202	50	9 4
QSB207	11-5/8" x 8-3/8" x 6"	10-1/6" x 7-1/8" x 6"	20	15 lbs	DSB207	50	12 4
QSB209	11-5/8" x 11-1/8" x 6"	10-1/6" x 10" x 6"	8	8 lbs	DSB209	50	18 6
QSB218 NEW	11-5/8" x 16-1/2" x 6"	10" x 15" x 6"	6	8 lbs	DSB218/222 LDSB218	24 6	27 8
QSB203	17-7/8" x 4-1/8" x 6"	16-1/2" x 3" x 6"	20	18 lbs	DSB203	50	9 3
QSB204	17-7/8" x 6-5/8" x 6"	16-1/2" x 5-1/2" x 6"	20	22 lbs	DSB204	50	15 6
QSB208	17-7/8" x 8-3/8" x 6"	16-1/2" x 7-1/8" x 6"	10	13 lbs	DSB208	50	19 6
QSB210	17-7/8" x 11-1/8" x 6"	16-1/2" x 10" x 6"	8	12 lbs	DSB210	50	29 8
QSB222 NEW	17-7/8" x 16-1/2" x 6"	16" x 15" x 6"	6	12 lbs	DSB218/222 LDSB222	24 6	41 15
QSB205	23-5/8" x 4-1/8" x 6"	22-1/8" x 3" x 6"	16	19 lbs	DSB205	50	13 4
QSB206	23-5/8" x 6-5/8" x 6"	22-1/8" x 5-1/2" x 6"	8	12 lbs	DSB206	50	21 8
QSB214	23-5/8" x 8-3/8" x 6"	22-1/8" x 7-1/8" x 6"	6	10 lbs	DSB214	50	24 8
QSB216	23-5/8" x 11-1/8" x 6"	22-1/8" x 10" x 6"	6	13 lbs	DSB216	50	35 16

To order a full carton add **CS** suffix to Model No. QSB201BLCS. Note: Bins must be ordered in carton quantities only.



Dividers and Bin Cups

Optional black dividers fit snugly, horizontally across bins to create compartments. Each bin accepts up to 8 dividers. Bins have a slot at the very front allowing the open hopper to be closed off creating even more storage.

Bin cups have a raised, slotted label holder for easy parts identification. The entire bin cup may be removed for easy part retrieval. Available in 2 sizes and 2 colors.

Available in: ● Blue ● Yellow

MODEL NO.	OUTSIDE DIMENSIONS L" x W" x H"	CTN QTY	CTN WGT
QBC111	3-1/4" x 1-3/4" x 3"	48	4 lbs
QBC112	5-1/8" x 2-3/4" x 3"	48	7 lbs



PLASTIC STORAGE

STORE-MORE 6" SHELF BIN WIRE SHELVING SYSTEMS

STORE-MORE 6" Shelf Bin Wire Shelving Systems - Complete Packages

- Easy boltless assembly
- Wire allows air to circulate as well as provides ideal product visibility
- Durable chrome finish ensures years of heavy-duty dependability and service
- All welded shelf construction is supported with super strong wire trusses to provide up to 800 lb. capacity per shelf

Bins available in: ● Blue ● Red ● Yellow ● Clear (One color per unit)

MODEL NO.	NO. OF BINS	BIN DIMENSIONS L" x W" x H"	SHIP WGT
12"W x 36"L x 74"H - 9 Shelf Systems			
WR9-201	64 QSB201	11-5/8" x 4-1/8" x 6"	108 lbs
WR9-202	40 QSB202	11-5/8" x 6-5/8" x 6"	100 lbs
WR9-207	32 QSB207	11-5/8" x 8-3/8" x 6"	98 lbs
WR9-209	24 QSB209	11-5/8" x 11-1/8" x 6"	96 lbs
18"W x 36"L x 74"H - 9 Shelf Systems			
WR9-203	64 QSB203	17-7/8" x 4-1/8" x 6"	156 lbs
WR9-204	40 QSB204	17-7/8" x 6-5/8" x 6"	142 lbs
WR9-208	32 QSB208	17-7/8" x 8-3/8" x 6"	143 lbs
WR9-210	24 QSB210	17-7/8" x 11-1/8" x 6"	140 lbs
24"W x 36"L x 74"H - 9 Shelf Systems			
WR9-205	64 QSB205	23-5/8" x 4-1/8" x 6"	182 lbs
WR9-206	40 QSB206	23-5/8" x 6-5/8" x 6"	171 lbs
WR9-214	32 QSB214	23-5/8" x 8-3/8" x 6"	165 lbs
WR9-216	24 QSB216	23-5/8" x 11-1/8" x 6"	154 lbs

COMPLETE PACKAGES WITH BINS



Up to 800 lb. LOAD CAPACITY PER SHELF



MOBILIZE YOUR WIRE SHELVING

DB - Donut Bumper
Non-marking donut bumper used to protect walls and help cushion impact.

WR-00H (Mobile Kit)*
Set of four swivel thermoplastic resin 5" x 1-1/4" casters, two with brakes. Up to 1,200 lb. load capacity.
**Mobile kits recommended only for shelves 18" and deeper.*



WR9-202

STORE-MORE 6" Complete Bin Center

Complete bin systems are available with 4 different size bin options on a 12"W x 36"L x 39"H unit. This all-purpose bin center is an economical high density storage system that provides easy visibility to stored contents.

Bins available in: ● Blue ● Red ● Yellow ● Clear (One color per unit)

MODEL NO.	NO. OF BINS	BIN DIMENSIONS L" x W" x H"	SHIP WGT
12"W x 36"L x 36"H - 5 Shelf Systems			
WR5-39-1236-201	32 QSB201	11-5/8" x 4-3/8" x 6"	61 lbs
WR5-39-1236-202	20 QSB202	11-5/8" x 6-5/8" x 6"	57 lbs
WR5-39-1236-207	16 QSB207	11-5/8" x 8-3/8" x 6"	56 lbs
WR5-39-1236-209	12 QSB209	11-5/8" x 11-1/8" x 6"	55 lbs



WR5-39-1236-201



WR9-207



WR9-209



12 SIZES AND 4 COLORS AVAILABLE

CLEAR BINS
AVAILABLE **VIEW**



QSB809

QSB807

QSB802

QSB801

**LOW COST, LONG LASTING,
UNBREAKABLE, REUSABLE,
8" HIGH BINS**



LTR-1253
Clear Label Holder and Insert
Clear label holders and laser label inserts.
Clear label holders fit all 8" Shelf Bins.
Package of 25.



DLT-6

Divider Label Tab

Divider Label Tabs attach to existing dividers enabling sections of bins to be labeled. Tabs improve the visibility of bin labels and scanning of barcodes. Package of 6.

STORE-MAX 8" Shelf Bins



Our 8" high bins offer 95% more storage capacity when compared to the standard 4" high bins and 65% more than the 6" high bins. The new STORE-MAX 8" Bins will truly maximize and organize your space. Manufactured from high density polypropylene, STORE-MAX 8" Shelf Bins are the industry standard for quality. These bins feature a molded-in label holder, built-in rear hang-lock which allows bins to tilt out for complete access when on shelving. A wide hopper front allows complete access to the contents of the bin. Edges are reinforced for added strength. They are designed for 12", 18" and 24" deep shelf units, racks, or standard shelving. Optional dividers are a perfect accessory to subdivide and keep parts separated as needed.

Available in: ● Blue ● Red ● Yellow ● Clear

MODEL NO.	OUTSIDE DIMENSIONS L" x W" x H"	INSIDE DIMENSIONS L" x W" x H"	CTN QTY	CTN WGT	CTN DIVIDER	CTN QTY	NO. OF BIN CUPS PER BIN QBC111	QBC112
QSB801	11-5/8" x 4-1/8" x 8"	10-1/6" x 3" x 8"	36	27 lbs	DSB801	50	6	2
QSB802	11-5/8" x 6-5/8" x 8"	10-1/6" x 5-1/2" x 8"	30	26 lbs	DSB802	50	9	4
QSB807	11-5/8" x 8-3/8" x 8"	10-1/6" x 7-1/8" x 8"	20	21 lbs	DSB807	50	12	4
QSB809	11-5/8" x 11-1/8" x 8"	10-1/6" x 10" x 8"	8	11 lbs	DSB809	50	18	6
QSB803	17-7/8" x 4-1/8" x 8"	16-1/2" x 3" x 8"	20	22 lbs	DSB803	50	9	3
QSB804	17-7/8" x 6-5/8" x 8"	16-1/2" x 5-1/2" x 8"	20	26 lbs	DSB804	50	15	6
QSB808	17-7/8" x 8-3/8" x 8"	16-1/2" x 7-1/8" x 8"	10	15 lbs	DSB808	50	19	6
QSB810	17-7/8" x 11-1/8" x 8"	16-1/2" x 10" x 8"	8	17 lbs	DSB810	50	29	8
QSB805	23-5/8" x 4-1/8" x 8"	22-1/8" x 3" x 8"	16	24 lbs	DSB805	50	13	4
QSB806	23-5/8" x 6-5/8" x 8"	22-1/8" x 5-1/2" x 8"	8	13 lbs	DSB806	50	21	8
QSB814	23-5/8" x 8-3/8" x 8"	22-1/8" x 7-1/8" x 8"	6	12 lbs	DSB814	50	24	8
QSB816	23-5/8" x 11-1/8" x 8"	22-1/8" x 10" x 8"	6	14 lbs	DSB816	50	35	16

To order a full carton add **CS** suffix to Model No. QSB801BLCS. Note: Bins must be ordered in carton quantities only.



Dividers and Bin Cups

Optional black dividers fit snugly, horizontally across bins to create compartments. Each bin accepts up to 7 dividers.

Bin cups have a raised, slotted label holder for easy parts identification. The entire bin cup may be removed for easy part retrieval. Available in 2 sizes and 2 colors.

Available in: ● Blue ● Yellow

MODEL NO.	OUTSIDE DIMENSIONS L" x W" x H"	CTN QTY	CTN WGT
QBC111	3-1/4" x 1-3/4" x 3"	48	4 lbs
QBC112	5-1/8" x 2-3/4" x 3"	48	7 lbs



PLASTIC STORAGE

STORE-MAX 8" SHELF BIN WIRE SHELVING SYSTEMS

COMPLETE PACKAGES WITH BINS



Up to 800 lb. LOAD CAPACITY PER SHELF



MOBILIZE YOUR WIRE SHELVING

DB - Donut Bumper
Non-marking donut bumper used to protect walls and help cushion impact.

WR-00H (Mobile Kit)*
Set of four swivel thermoplastic resin 5" x 1-1/4" casters, two with brakes. Up to 1,200 lb. load capacity. *Mobile kits recommended only for shelves 18" and deeper.



WR8-801



WR8-802



WR8-809

STORE-MAX 8" Shelf Bin Wire Shelving Systems - Complete Packages

- Easy boltless assembly
- Wire allows air to circulate as well as provides ideal product visibility
- Durable chrome finish ensures years of heavy-duty dependability and service
- All welded shelf construction is supported with super strong wire trusses to provide up to 800 lb. capacity per shelf

Bins available in: ● Blue ● Red ● Yellow ● Clear (One color per unit)

MODEL NO.	NO. OF BINS	BIN DIMENSIONS L" x W" x H"	SHIP WGT
12"W x 36"L x 74"H - 8 Shelf Systems			
WR8-801	49 QSB801	11-5/8" x 4-3/8" x 8"	100 lbs
WR8-802	35 QSB802	11-5/8" x 6-5/8" x 8"	103 lbs
WR8-807	28 QSB807	11-5/8" x 8-3/8" x 8"	102 lbs
WR8-809	21 QSB809	11-5/8" x 11-1/8" x 8"	101 lbs
18"W x 36"L x 74"H - 8 Shelf Systems			
WR8-803	49 QSB803	17-7/8" x 4-3/8" x 8"	150 lbs
WR8-804	35 QSB804	17-7/8" x 6-5/8" x 8"	142 lbs
WR8-808	28 QSB808	17-7/8" x 8-3/8" x 8"	138 lbs
WR8-810	21 QSB810	17-7/8" x 11-1/8" x 8"	141 lbs
24"W x 36"L x 74"H - 8 Shelf Systems			
WR8-805	49 QSB805	23-5/8" x 4-3/8" x 8"	194 lbs
WR8-806	35 QSB806	23-5/8" x 6-5/8" x 8"	177 lbs
WR8-814	28 QSB814	23-5/8" x 8-3/8" x 8"	176 lbs
WR8-816	21 QSB816	23-5/8" x 11-1/8" x 8"	169 lbs

STORE-MAX 8" Complete Bin Center

Complete bin systems are available with 4 different size bin options on a 12"W x 36"L x 39"H unit. This all-purpose bin center is an economical high density storage system that provides easy visibility to stored contents.

Bins available in: ● Blue ● Red ● Yellow ● Clear (One color per unit)

MODEL NO.	NO. OF BINS	BIN DIMENSIONS L" x W" x H"	SHIP WGT
12"W x 36"L x 39"H - 4 Shelf Systems			
WR4-39-1236-801	21 QSB801	11-5/8" x 4-3/8" x 8"	80 lbs
WR4-39-1236-802	15 QSB802	11-5/8" x 6-5/8" x 8"	78 lbs
WR4-39-1236-807	12 QSB807	11-5/8" x 8-3/8" x 8"	77 lbs
WR4-39-1236-809	9 QSB809	11-5/8" x 11-1/8" x 8"	77 lbs



WR4-39-1236-807

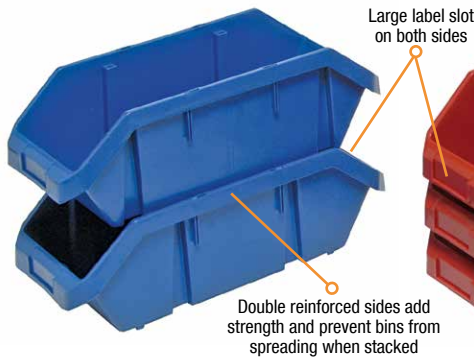

STACK 'EM

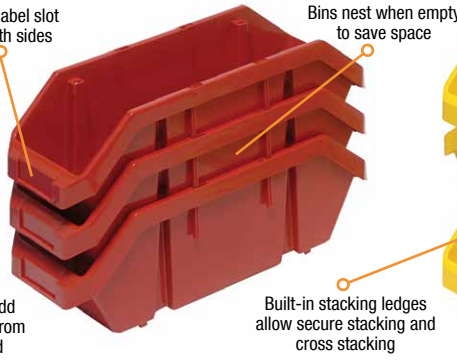

NEST 'EM

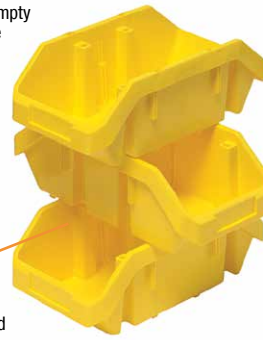

CROSS STACK 'EM



QP1265
Shown with optional Dividers **CD1265/LD1265**

QuickPick Bin



6 SIZES AND 3 COLORS AVAILABLE

Dividers

These heavy-duty, polypropylene storage bins provide an open hopper front and back, allowing double sided access to stored parts. Bins stack one on top of the other, both vertically and cross-wise, and nest when empty for space efficiency. Optional dividers may be used front to back, side to side, or both at the same time, dividing the bin into four sections. A molded in label holder on both the front and back of the bin allows for easy parts identification. Bins can be used on standard metal or wire shelving as well as on desks, bench tops or work stations.

Available in: ● Blue ● Red ● Yellow

MODEL NO.	DIMENSIONS L" x W" x H"	X**	CTN QTY	CTN WGT	CROSS DIVIDER	CTN QTY	LENGTH DIVIDER	CTN QTY	CLEAR LABEL HOLDER & INSERT
QP965	9-1/2" x 6-5/8" x 5"	6"	20	15 lbs	CD965	10	LD965	10	LTR-1253
QP1265	12-1/2" x 6-5/8" x 5"	9"	20	19 lbs	CD1265	10	LD1265	10	LTR-1253
QP1285	12-1/2" x 8-3/8" x 5"	9"	20	22 lbs	CD1285	10	LD1285	10	LTR-1253
QP1496	14" x 9-1/4" x 6-1/2"	8-1/8"	20	26 lbs	CD1496	10	LD1496	10	LTR-1253
QP1867	18-1/2" x 6-5/8" x 7"	13-1/8"	10	16 lbs	CD1867	10	LD1867	10	LTR-1253
QP1887	18-1/2" x 8-3/8" x 7"	13-1/8"	10	18 lbs	CD1887	10	LD1887	10	LTR-1253

X dimensions is inside flat bottom length. To order a full carton add **CS** suffix to Model No. QP965BLCS. Note: Bins must be ordered in carton quantities only.



LTR-1253
Clear Label Holder & Insert
Clear label holders and laser label inserts. Fits all QuickPick Bins. Package of 25.

Optional dividers may be used front to back, side to side or both at the same time, dividing the bin into four sections.

THE MOST VERSATILE BIN IN THE INDUSTRY WITH DOUBLE SIDED ACCESS



WRC3-1836-1867

QuickPick Bin Mobile Wire Cart

Carts are available in a 2 or 3 shelf configuration complete with four casters (all swivel, two with brakes). Overall dimensions: 18"W x 36"L x 37-1/2"H. Mobile cart is easy to assemble. One color per cart.

Bins available in: ● Blue ● Red ● Yellow (One color per unit)

MODEL NO.	NO. OF BINS	DIMENSIONS L" x W" x H"	CTN WGT
WRC2-1836-1265	10 QP1265	12-1/2" x 6-5/8" x 5"	49 lbs
WRC3-1836-1265	15 QP1265	12-1/2" x 6-5/8" x 5"	64 lbs
WRC2-1836-1285	8 QP1285	12-1/2" x 8-3/8" x 5"	48 lbs
WRC3-1836-1285	12 QP1285	12-1/2" x 8-3/8" x 5"	63 lbs
WRC2-1836-1867	10 QP1867	18-1/2" x 6-5/8" x 7"	55 lbs
WRC3-1836-1867	15 QP1867	18-1/2" x 6-5/8" x 7"	73 lbs
WRC2-1836-1887	8 QP1887	18-1/2" x 8-3/8" x 7"	54 lbs
WRC3-1836-1887	12 QP1887	18-1/2" x 8-3/8" x 7"	72 lbs

Heavy-Duty Wire Shelving with QuickPick Bins - Complete Packages

These unique shelving packages provide double sided access to stored parts. QuickPick Bins allow two users to access stored product at the same time. This ergonomic, space efficient work station is the ultimate space saver. Shelving systems measure 18"W x 36"L x 74"H and may be ordered with or without a mobile kit. These heavy-duty systems offer up to 800 lb. capacity per shelf. Optional dividers may be used front to back, side to side or both at the same time, dividing the bin into four sections. A molded in label holder on both the front and back of the bin allows for easy part identification.

Bins available in: ● Blue ● Red ● Yellow (One color per unit)

MODEL NO.	NO. OF BINS	DIMENSIONS L" x W" x H"	SHIP WGT
W7-12-30	30 QP1265	12-1/2" x 6-5/8" x 5"	110 lbs
W7-12-26	10 QP1265 16 QP1285	12-1/2" x 6-5/8" x 5" 12-1/2" x 8-3/8" x 5"	107 lbs
W7-12-28	20 QP1265 8 QP1285	12-1/2" x 6-5/8" x 5" 12-1/2" x 8-3/8" x 5"	109 lbs
W7-12-24	24 QP1285	12-1/2" x 8-3/8" x 5"	106 lbs
W7-14-18	18 QP1496	14" x 9-1/4" x 6-1/2"	105 lbs
W7-18-30	30 QP1867	18-1/2" x 6-5/8" x 7"	128 lbs
W7-18-26	10 QP1867 16 QP1887	18-1/2" x 6-5/8" x 7" 18-1/2" x 8-3/8" x 7"	125 lbs
W7-18-28	20 QP1867 8 QP1887	18-1/2" x 6-5/8" x 7" 18-1/2" x 8-3/8" x 7"	127 lbs
W7-18-24	24 QP1887	18-1/2" x 8-3/8" x 7"	124 lbs

Mobile Kit

WR-00H* Mobilizes Wire Shelving Unit 14 lbs

*Set of four swivel thermoplastic resin 5" x 1-1/4" casters, two with brakes. 1,200 lb. load capacity. Mobile kits recommended only for shelves 18" and deeper.

Up to 800 lb. LOAD CAPACITY PER SHELF



W7-12-26



BULK CONTAINERS

LATCH CONTAINERS & WIRE SHELVING SYSTEM

Latch Containers & Wire Shelving System - Complete Packages



Quantum's new Latch Containers feature heavy-duty latches on each end that snap lock providing a tight and secure fit. Once latch is engaged parts inside are fully protected from dirt or getting wet. These durable and ultra-strong containers can hold up to 75 lbs. Injection molded from durable, high impact polypropylene. Lids feature reinforced ribs that allow totes to safely and securely stack on top of each other.

Available in: ● Black ● Clear

MODEL NO.	OUTSIDE DIMENSIONS L" x W" x H"		INSIDE TOP DIMENSIONS L" x W" x H"		INSIDE BOTTOM DIMENSIONS L" x W"		CAP GAL	CTN QTY	CTN WGT LBS	LID	CTN QTY
LC191507	21" x 15-7/8" x 7-3/4"	18-3/8" x 14-5/8" x 7-1/4"	15-7/8" x 12-7/8"	7.03	6	12 lbs	LID1915	6			
LC191507CL	21" x 15-7/8" x 7-3/4"	18-3/8" x 14-5/8" x 7-1/4"	15-7/8" x 12-7/8"	7.03	6	12 lbs	LID1915CL	6			

To order a full carton add **CS** suffix to Model No. LC191507BKCS. Note: Bins must be ordered in carton quantities only.



LID1915 and LID1915CL Latch Container Lid



LC191507CL and LID1915CL

CONTAINERS HOLD Up to 75 lbs.



LC191507 and LID1915



LC191507CL Containers Nesting



LC191507CL and LID1915CL Containers Stacked with Lid



WR6-191507CL 21"W x 36"L x 74"H 6 shelves with 12 LC191507CL and 12 LID1915CL



WR6-191507 21"W x 36"L x 74"H 6 shelves with 12 LC191507 and 12 LID1915



MOBILIZE YOUR WIRE SHELVING

DB - Donut Bumper
Non-marking donut bumper used to protect walls and help cushion impact.

WR-00H (Mobile Kit)*
Set of four swivel thermoplastic resin 5" x 1-1/4" casters, two with brakes. Can be used with all units shown. 1,200 lb. load capacity. *Mobile kits recommended only for shelves 18" and deeper.



11 SIZES AND 4 COLORS AVAILABLE



DIVIDERS

Containers can be divided by length and/or width allowing a subdivision down to a 1-1/8" square compartment size. Available in Gray.



SNAP ON COVERS

Snap on covers protect contents from damage or dust during shipping and storage.



CLEAR LABEL HOLDER

Fits any size container. Three sizes to choose from. Attach via Velcro fastening.



DG92060

Shown with optional Clear Dust Cover Acrylic Inlay

Clear Dust Cover Acrylic Inlays

Clear Acrylic Dust Cover Inlays keep stored items visible while protecting against airborne dust and other contaminants. Cover lays inside on recessed rim of container.

MODEL NO.	FITS BIN MODEL NO.	CTN QTY
DDC91000CL	DG91025, DG91035, DG91050	10
DDC92000CL	DG92035, DG92050, DG92060, DG92080	4
DDC93000CL	DG93030, DG93060, DG93080, DG93120	3



DG93030

COV91000

DG93060

DG91050

DG93080

DG92035

DG92050

DG91025

DG92080

DG91035

DG93120

DG92060

Shown with optional Clear Label Holder

Dividable Grid Containers



Heavy-duty Dividable Grid Containers can be used in industrial, commercial, electronic and health care industries for storage, assembly, fabrication and distribution applications. These containers offer the safest and most efficient method for compartmentalizing and protecting small to medium sized parts. Dividers allow you to customize the container's interior to meet your exact needs. Containers and covers are available in 4 colors.

Available in: ● Blue ● Gray ● Red ● Clear

MODEL NO.	OUTSIDE DIMENSIONS L" x W" x H"	INSIDE DIMENSIONS L" x W" x H"	CTN QTY	CTN WGT	LONG DIVIDER	CTN QTY	SHORT DIVIDER	CTN QTY	COVER	CTN QTY
DG91025	10-7/8" x 8-1/4" x 2-1/2"	9-3/16" x 6-9/16" x 2"	20	16 lbs	DL91025	6	DS91025	6	COV91000	10
DG91035	10-7/8" x 8-1/4" x 3-1/2"	9-3/16" x 6-9/16" x 3"	20	24 lbs	DL91035	6	DS91035	6	COV91000	10
DG91050	10-7/8" x 8-1/4" x 5"	9-3/16" x 6-9/16" x 4-1/2"	20	32 lbs	DL91050	6	DS91050	6	COV91000	10
DG92035	16-1/2" x 10-7/8" x 3-1/2"	14-7/8" x 9-1/4" x 3"	12	23 lbs	DL92035	6	DS92035	6	COV92000	4
DG92050	16-1/2" x 10-7/8" x 5"	14-7/8" x 9-1/4" x 4-1/2"	12	25 lbs	DL92050	6	DS92050	6	COV92000	4
DG92060	16-1/2" x 10-7/8" x 6"	14-7/8" x 9-1/4" x 5-1/2"	8	20 lbs	DL92060	6	DS92060	6	COV92000	4
DG92080	16-1/2" x 10-7/8" x 8"	14-7/8" x 9-1/4" x 7-1/2"	8	27 lbs	DL92080	6	DS92080	6	COV92000	4
DG93030	22-1/2" x 17-1/2" x 3"	20-5/8" x 15-5/8" x 2-1/2"	6	20 lbs	DL93030	6	DS93030	6	COV93000	3
DG93060	22-1/2" x 17-1/2" x 6"	20-5/8" x 15-5/8" x 5-1/2"	3	16 lbs	DL93060	6	DS93060	6	COV93000	3
DG93080	22-1/2" x 17-1/2" x 8"	20-5/8" x 15-5/8" x 7-1/2"	3	19 lbs	DL93080	6	DS93080	6	COV93000	3
DG93120	22-1/2" x 17-1/2" x 12"	20-5/8" x 15-5/8" x 11-1/2"	3	23 lbs	DL93120	6	DS93120	6	COV93000	3

To order a full carton add **CS** suffix to Model No. DG91025**BLCS**. Note: Bins must be ordered in carton quantities only.

Clear Label Holders

MODEL NO.	DIMENSIONS H" x W"	FITS BIN MODEL NO.	CTN QTY
LBL2X8	2" x 8"	DG91025, DG91035, DG92035, DG93030	6
LBL3X5	3" x 5"	DG91050, DG92050, DG92060, DG93060	6
LBL5X8	5" x 8"	DG92080, DG93080, DG93120	6

Clear Covers

MODEL NO.	FITS BIN MODEL NO.	CTN QTY
COV91000CL	DG91025, DG91035, DG91050	10
COV92000CL	DG92035, DG92050, DG92060, DG92080	4
COV93000CL	DG93030, DG93060, DG93080, DG93120	3

DG92060 and DG93060

Shown with optional Dividers and Clear Covers



BULK CONTAINERS

GENUINE STACK AND NEST TOTES



9 SIZES AND 4 COLORS AVAILABLE



Genuine stack and nest totes



These heavy-duty, tough, and dependable stack and nest totes are the ultimate reusable container for storing and transporting your valuable items in any application. These proven containers are available in nine sizes and three colors for efficiency and inventory control.

Available in: ● Blue ● Gray ● Red ● Clear

MODEL NO.	OUTSIDE DIMENSIONS L" x W" x H"	A	B	INSIDE DIMENSIONS			CAPACITY (CU FT)	CTN QTY	CTN WGT	LID	CTN QTY		
				C	D	E							
snt180	18" x 11" x 6"	10"	16"	15-1/4"	9-3/8"	5-7/8"	0.50	6	12 lbs	LID181	6		
snt185	18" x 11" x 9"	10"	16"	15-1/8"	9-1/8"	8-7/8"	0.76	6	15 lbs	LID181	6		
snt190	19-1/2" x 15-1/2" x 10"	14-1/2"	17"	16"	13-1/4"	9-7/8"	1.20	6	23 lbs	LID191	6		
snt195	19-1/2" x 15-1/2" x 13"	14-1/2"	17"	15-7/8"	13-3/8"	12-7/8"	1.70	6	26 lbs	LID191	6		
snt200	19-1/2" x 13-1/2" x 8"	12-3/8"	17-7/8"	16-3/8"	11-1/2"	7-7/8"	0.80	6	19 lbs	LID201	6		
snt225	23-1/2" x 19-1/2" x 10"	18-1/4"	20-7/8"	19-3/8"	16-7/8"	9-7/8"	2.00	3	18 lbs	LID231	3		
snt230	23-1/2" x 19-1/2" x 13"	18-1/8"	20-7/8"	19-1/2"	16-7/8"	12-7/8"	2.60	3	22 lbs	LID231	3		
snt240	23-1/2" x 15-1/2" x 12"	14-1/4"	20-7/8"	19-5/8"	13"	11-7/8"	1.70	3	18 lbs	LID241	3		
snt300	29-1/2" x 19-1/2" x 15"	18-1/4"	26-5/8"	25-1/8"	16-5/8"	14-7/8"	3.70	3	31 lbs	LID301	3		
snh010	Clear Label Holder - 3" x 5" (Fits all tote sizes)										6	1 lb	-

To order a full carton add **CS** suffix to Model No. snt180BL**CS**. Note: Bins must be ordered in carton quantities only.

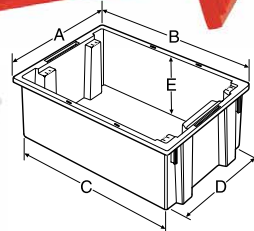

Bin Inside Dimensions Guide
A (top width) **B** (top length) **E** (height)
C (bottom length) **D** (bottom width)



snh010

All nine sizes of totes have ability to use our optional 3" x 5" clear label holder. It securely attaches to tote with or without lid for easy part identification.



AL-35

3" x 5" Clear Adhesive Label Holder and Inserts attaches securely to container for easy part identification. Package of 24.



Optional lid snaps on tightly and securely to protect container contents. As pictured, lids can be fastened and locked for added security.

stack and nest totes PERFORMANCE FEATURES:

- Available in 9 sizes
- Standard colors: Blue, Gray, Red and Clear
- Totes are injection molded from high-density polypropylene material and are manufactured from FDA and USDA approved materials
- stack and nest totes will not corrode, bend out of shape, are unaffected by chemicals and are waterproof
- Reusable container will stack with or without lids for maximum storage and shipping
- snt's have the unique ability to stack or they can be turned 180° to nest when empty saving valuable space
- Optional lids for totes can be secured with nylon ties
- Textured bottoms ensure safe and easy, non-slip grip in transit on conveyors

LIGHTWEIGHT, HEAVY-DUTY HDPE SIMPLE SNAP-TOGETHER DESIGN

Up to **500-2,700 lb.** LOAD CAPACITY

Polymer Dunnage Rack

MODEL NO.	DIMENSIONS W" x L" x H"	SHIP WGT
Ventilated Top		
362412DPP	24" x 36" x 12"	13 lbs
363612DPP	36" x 36" x 12"	22 lbs
482412DPP	24" x 48" x 12"	19 lbs
662412DPP	24" x 66" x 12"	23 lbs
663612DPP	36" x 66" x 12"	37 lbs
962412DPP	24" x 96" x 12"	34 lbs
963612DPP	36" x 96" x 12"	53 lbs
Solid Top		
362412DPS	24" x 36" x 12"	17 lbs
363612DPS	36" x 36" x 12"	26 lbs
482412DPS	24" x 48" x 12"	21 lbs
662412DPS	24" x 66" x 12"	28 lbs
663612DPS	36" x 66" x 12"	49 lbs
962412DPS	24" x 96" x 12"	41 lbs
963612DPS	36" x 96" x 12"	64 lbs



For more detailed info See pg. 71



Solid Top

Ventilated Top



Polymer Dunnage Rack



Chrome Wire Shelving System with Genuine stack and nest totes



Offering up to 600-800 lb. load capacity per shelf, this chrome wire shelving system with totes is a must have for archival storage, heavy-duty parts organization or inventory control applications. With three packages to choose from offering three colors choices for the bins, this system can be used just about anywhere. System may be made mobile with the addition of the **WR-00H** mobile kit. See *pg. 124* for additional information and to order optional accessories.

Up to 600-800 lb. LOAD CAPACITY PER SHELF

MODEL NO.	NO. OF SHELVES	NO. OF BINS	BIN DIMENSIONS L" x W" x H"	SHIP WGT
18"W x 48"L x 74"H - Wire Shelving Systems with stack and nest totes - Totes are available in Gray, Blue, Red and Clear				
WR9-36180	9	36 snt180	18" x 11" x 6"	178 lbs
WR6-24185	6	24 snt185	18" x 11" x 9"	136 lbs
24"W x 66"L x 63"H - Wire Shelving System with stack and nest totes - Totes are available in Gray, Blue, Red and Clear				
WR4-12225	4	12 snt225	23-1/2" x 19-1/2" x 10"	170 lbs

WR9-36180
Shown with optional lid and label holders (Sold separately)



MOBILIZE YOUR WIRE SHELVING

DB - Donut Bumper
Non-marking donut bumper used to protect walls and help cushion impact.

WR-00H (Mobile Kit)
Set of four swivel thermoplastic resin 5" x 1-1/4" casters, two with brakes. Can be used with all units shown. Up to 1,200 lb. load capacity.

Chrome Mobile Wire Shelving Systems with Cross Stack Tubs & QuanTub Nesting Tote

These unique packages provide a storage solution for large, bulky items. These heavy-duty tubs provide easy access to stored parts for assembly areas, picking stations or inventory control. With three packages to choose from, these strong durable totes provide a durable solution for most applications. See *pg. 85* for more information.

MODEL NO.	NO. OF SHELVES	NO. OF BINS	BIN DIMENSIONS L" x W" x H"	SHIP WGT
24"W x 60"L x 69"H - Mobile, Wire Shelving System with QuanTub Totes - Totes are available in Gray and Blue				
MWR4-2419-9	4	12 TUB2419-9	24-1/2" x 19" x 9-1/2"	175 lbs
18"W x 36"L x 69"H - Mobile, Wire Shelving System with Cross Stack Tubs - Tubs are available in Gray, Blue and White				
MWR7-1711-8	7	24 TUB1711-8	17-1/4" x 11" x 8"	151 lbs
MWR5-1711-12	5	15 TUB1711-12	17-1/4" x 11" x 12"	118 lbs

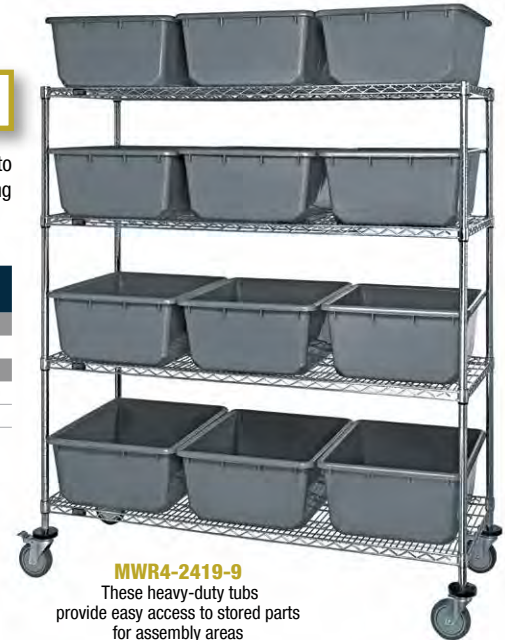

MWR4-2419-9
These heavy-duty tubs provide easy access to stored parts for assembly areas

COMPLETE PACKAGES WITH BINS

WR7-92080
Allow for multiple compartment configurations within each bin



Chrome Wire Shelving System with Dividable Grid Containers

Same durable chrome wire shelving combined with Quantum's Dividable Grid Containers. These containers allow for multiple compartment configurations within each bin. Offering four different packages, these systems are ideal for small and medium parts storage. System may be made mobile with the addition of the **WR-00H** mobile kit. See *pg. 123* for additional container information and to order optional container accessories.

Up to 600-800 lb. LOAD CAPACITY PER SHELF

MODEL NO.	NO. OF SHELVES	NO. OF BINS	BIN DIMENSIONS L" x W" x H"	SHIP WGT
18"W x 48"L x 74"H - Wire Shelving Systems with Dividable Grid Containers - Containers are available in Gray, Blue, Red and Clear				
WR9-92060	9	36 DG92060	16-1/2" x 10-7/8" x 6"	210 lbs
WR7-92080	7	24 DG92080	16-1/2" x 10-7/8" x 8"	174 lbs
24"W x 60"L x 63"H - Wire Shelving System with Dividable Grid Containers - Containers are available in Gray, Blue, Red and Clear				
WR12-93030	12	36 DG93030	22-1/2" x 17-1/2" x 3"	274 lbs
WR9-93060	9	24 DG93060	22-1/2" x 17-1/2" x 6"	254 lbs





Stackers - Heavy-Duty Straight Wall Stacking Container



Heavy-duty, straight wall containers maximize your space when used for shipping, storage or work-in progress. Greater strength and durability provided by reinforced corners allowing this strong container to hold the heaviest of parts. Containers are injection molded from high-density polyethylene. Straight wall design allows for modular stacking of all sizes on standard pallets. Hand grips on two sides make the container easy to handle and carry. Up to 175 lb. stack capacity.

Available in: ● Gray

MODEL NO.	OUTSIDE DIMENSIONS L" x W" x H"	INSIDE DIMENSIONS L" x W" x H"	CTN QTY	VOLUME (CU FT)	SHIP WGT	LID
RS01207-5	12" x 7-1/2" x 5"	9-3/4" x 5-1/2" x 4-7/8"	1	0.1	2 lbs	-
RS01215-5	12" x 15" x 5"	9-1/2" x 13" x 4-7/8"	1	0.3	2 lbs	LID1215
RS01215-7	12" x 15" x 7-1/2"	9-1/2" x 13" x 7"	1	0.5	3 lbs	LID1215
RS02415-5	24" x 15" x 5"	21-1/2" x 13" x 4-7/8"	1	0.7	4 lbs	LID2415
RS02415-7	24" x 15" x 7-1/2"	21-1/2" x 13" x 7"	1	1.1	5 lbs	LID2415
RS02415-9	24" x 15" x 9-1/2"	21-1/2" x 13" x 9"	1	1.4	5 lbs	LID2415
RS02422-11*	24" x 22-1/2" x 11"	21-1/2" x 20-1/2" x 10-1/4"	1	3.5	8 lbs	-

*Cannot be used on DLY-2415. Use with DLY-3018 Dolly.

7 SIZES AVAILABLE

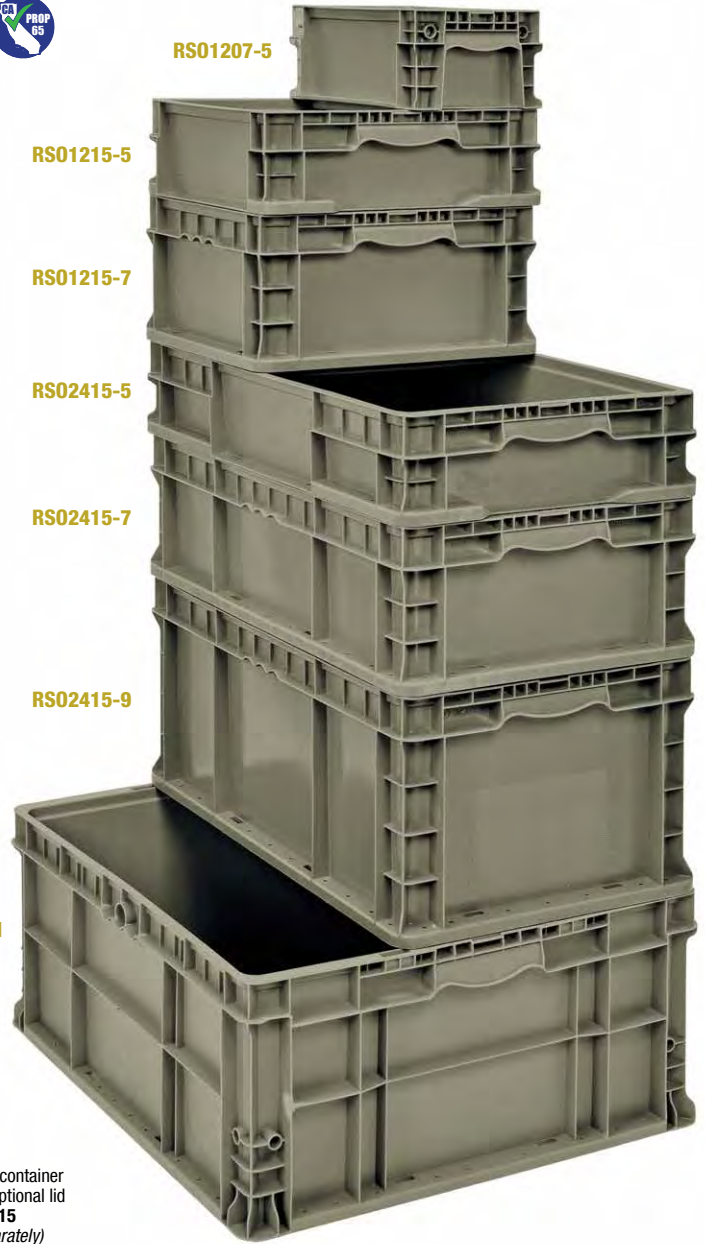
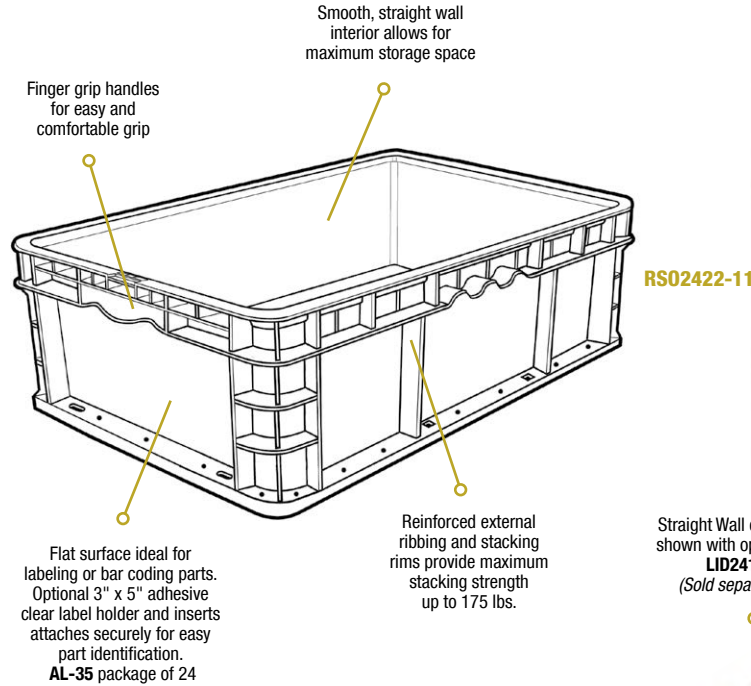

Straight Wall container shown with optional lid LID2415 (Sold separately)

MOBILIZE YOUR BINS

Polymer Dollies

DLY-2415 is 24"L x 15"W with 1" Ledge, available in Black.
DLY-3018 is 30"L x 18"W with padded rubber trim, available in Blue.
Set of four 4" x 1-1/4" non-marking swivel poly casters.
Both dollies have up to 1,000 lb. load capacity.

MODEL NO.	DESCRIPTION	CTN WGT
DLY-2415	Dolly with 1" Ledge	14 lbs
DLY-3018	Dolly with Padded Rubber Trim	19 lbs

Bins sold separately



DLY-2415
Interior Dimensions 24"L x 15"W
Exterior Dimensions 28"L x 18-1/2"W



9 SIZES AVAILABLE

Stronger corner design means increased durability which translates to fewer damaged containers

Secure plastic hinges make containers safer to handle and easier to recycle at end-of-life

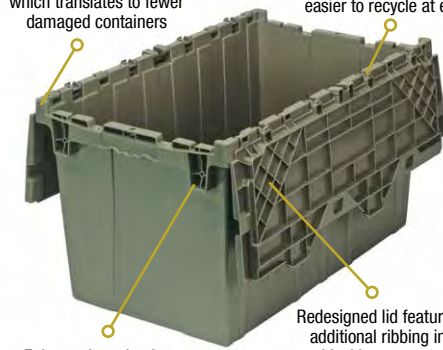

Enhanced nesting lug increases strength when stacking nested containers

Redesigned lid features additional ribbing in critical impact areas

QDC2115-17

QDC2115-12



PLASTIC HINGE
generation plastic hinge



QDC2115-9

Polymer Dolly

DLY-2415 Dolly with 1" Ledge, available in Black. Up to 1,000 lb. load capacity. Interior Dimensions 24"L x 15"W Exterior Dimensions 28"L x 18-1/2"W

MODEL NO.	DESCRIPTION	CTN WGT
DLY-2415	Dolly with 1" Ledge	14 lbs

Bins sold separately

STRONG, RELIABLE, REUSABLE TOTES

QDC2012-7

QDC2213-12

QDC2420-12

QDC2820-15



QDC2515-14

QDC2717-12



QDL-2115

Distribution container has an optional 3" x 5" adhesive clear label holder and insert which attaches securely for easy part identification. Package of 24.

Heavy-Duty Attached Top Containers - Perfect for distribution and supply centers

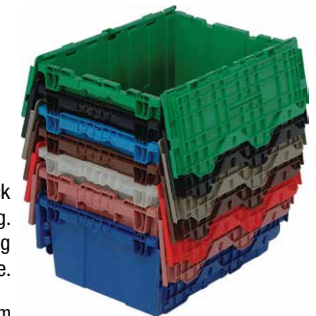

CUSTOM COLORS AVAILABLE

call for details



HOT STAMPING AVAILABLE

call for details

Strong, reliable and reusable totes are ideal for storage, distribution and order picking. Tops are permanently attached with hinges that interlock for stacking strength and security. Stack for maximized storage and nest when empty. Textured, non-slip bottom ensures smooth conveying. Ergonomically designed handles allow for easy lifting. Recessed lids ensure maximum load stability. Padlock eye provides security option allowing lids to be fastened and/or locked. Molded from high density, FDA approved polyethylene. Lids close securely to protect parts from dust or damage.

Available in: ● Gray ● Custom

MODEL NO.	OUTSIDE DIMENSIONS		INSIDE DIMENSIONS		CONTAINER HEIGHT	VOLUME (CU FT)	CAPACITY GAL	STACK CAP/ QTY STACKED	SHIP WGT
	TOP L" x W"	BOTTOM L" x W"	TOP L" x W"	BOTTOM L" x W"					
QDC2012-7	19-5/8" x 11-9/16"	17" x 9-1/4"	17-9/16" x 9-13/16"	16-1/4" x 8-5/8"	7-1/2"	0.50	8.75	45 lbs/7	4 lbs
QDC2115-9	21-3/4" x 14-7/8"	18-15/16" x 13-1/8"	19-5/8" x 14"	18-3/8" x 12-9/16"	9-5/8"	1.27	9.50	65 lbs/5	6 lbs
QDC2115-12	21-3/4" x 15"	18-9/16" x 12-5/8"	19-3/4" x 14"	18" x 12-1/4"	12-3/4"	1.67	12.50	75 lbs/5	7 lbs
QDC2115-17	21-7/8" x 15-1/8"	18-3/8" x 12-7/8"	20" x 14-1/2"	17-7/8" x 12-1/2"	17-1/4"	2.31	17.25	100 lbs/3	8 lbs
QDC2213-12**	22-1/8" x 12-5/8"	18-7/8" x 10-7/8"	19-7/8" x 12"	18-1/2" x 10-1/8"	11-7/8"	1.42	12.25	75 lbs/5	6 lbs
QDC2420-12**	23-7/8" x 19-3/8"	21-1/4" x 17-5/16"	22-1/4" x 18"	20-5/8" x 16-5/8"	12-1/2"	2.44	18.25	85 lbs/5	8 lbs
QDC2717-12	27-5/16" x 16-9/16"	24-1/4" x 14-1/2"	25-1/8" x 15-3/8"	23-3/8" x 13-3/4"	12-1/2"	2.50	18.75	100 lbs/4	8 lbs
QDC2515-14	25-3/8" x 16-1/4"	22-1/4" x 13-1/4"	23-1/8" x 14-1/4"	21-5/8" x 12-5/8"	14-1/8"	2.20	16.50	100 lbs/4	8 lbs
QDC2820-15*	28-1/8" x 20-5/8"	25-3/8" x 18-3/4"	25-7/8" x 19-3/4"	25-1/8" x 18"	15-5/8"	4.00	29.92	100 lbs/4	13 lbs

*Cannot be used on **DLY-2415**, use with **DLY-3018** Dolly **Manufactured with metal hinge



Bin, Tote and Container Labels



Labels facilitate parts identification and bar coding of the bin contents. Label sizes and availability vary per product. Correct labeling option(s) are specified alongside products details shown throughout the catalog.

INSERTS INCLUDED

Clear Label Holders and Inserts

Clear Label Holders easily slide into molded-in label slot on bin to protect label. Laser and inkjet compatible inserts come in 8-1/2" x 11" perforated sheets. Each package includes 25 clear holders and corresponding printer friendly sheet labels.

6 MODELS AVAILABLE



LTR-700, LTR-0813, LTR-1253, LTR-1300, LTR-1754, LTR-2400

Adhesive Label Holders and Inserts

Adhesive Label Holders are designed to work with bins without molded-in label slots. These label holders will attach securely to a flat surface. Laser and inkjet compatible inserts come in 8-1/2" x 11" perforated sheets. Each package includes 24 adhesive holders and corresponding printer friendly sheet labels.



AL-23



AL-35

Bin Rear Label Holder

New Rear Bin Label Holder clips to the back portion of any plastic bin. Creates a vertical extension for a 1" x 3" label or barcode making it easy to identify the contents of that bin. Each package includes 12 clear holders and corresponding printer friendly sheet labels.



RLH1X3C

INSERTS NOT INCLUDED

Label Holders for Dividable Grid Containers

Label Holders are available for standard and conductive dividable grid containers. Three sizes to choose from (2" x 8", 3" x 5" and 5" x 8"). Package of 6.



CLEAR LABEL HOLDER



CONDUCTIVE LABEL HOLDER

Clear Hanging Label Holder

3" x 5" Clear Hanging Label Holder securely attaches to all sizes of stack and nest totes and cross stack tubs. Label holder can be used on totes and tubs with or without lids for easy part identification. Package of 6.



FITS ALL CROSS STACK TUBS

snh010



FITS ALL stack and nest TOTES

Extended Label Holders

Extended Label Holders are designed to slide into the molded label slot of bins to allow for larger bar code scanning or just larger labels. Label holders fit all 4", 6" and 8" Shelf Bins. Provides a 4" x 2-1/4" flat angled surface. Package of 24.

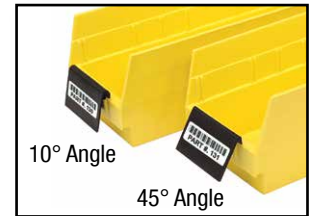

10° Angle

45° Angle

ELH410 and ELH445

Divider Label Tab

Divider Label Tabs attach directly to existing dividers enabling sections of bin to be labeled. Multiple tabs improve the visibility of bin labels and scanning of barcodes. Package of 6.



DLT-6



Plastic Drawer Cabinets



- Heavy-duty reinforced construction.
- Each see through drawer includes a divider.
- Stable stacking and easy wall mounting with pre-configured holes on rear side.
- Drawer stops on each drawer prevents spills.
- Textured drawer pull surface.
- Durable high impact polypropylene frame with clear polypropylene drawers and bins.

Available in: ● Black and Gray

MODEL NO.	OUTSIDE DIMENSIONS L" x W" x H"	DRAWER QTY	DRAWER DIMENSIONS L" x W" x H"	PKG QTY	PKG WGT
PDC-12BK	6-1/4" x 10-1/2" x 10-1/4"	8 Drawers 4 Drawers	5-1/2" x 2" x 1-1/4" 5-1/2" x 4-1/4" x 2"	1	3 lbs
PDC-18BK	6-1/4" x 15" x 18-3/4"	18 Drawers	5-1/2" x 4-1/4" x 2"	1	5 lbs
PDC-22BK	6-1/4" x 19-1/2" x 10"	14 Drawers 8 Drawers	5-1/2" x 2" x 1-1/4" 5-1/2" x 4-1/4" x 2"	1	5 lbs
PDC-39BK	6-1/4" x 15" x 18-3/4"	30 Drawers 9 Drawers	5-1/2" x 2" x 1-1/4" 5-1/2" x 4-1/4" x 2"	1	6 lbs
PDC-60BK	6-1/4" x 15" x 18-3/4"	60 Drawers	5-1/2" x 2" x 1-1/4"	1	7 lbs
PDC-930BK	6-1/4" x 15" x 18-3/4"	30 Drawers 9 Bins	5-1/2" x 2" x 1-1/4" 5-1/2" x 4-1/4" x 2-3/4"	1	6 lbs



PDC-12BK



PDC-18BK

**EASY TO IDENTIFY
ITEMS INSIDE**



PDC-22BK



PDC-39BK



PDC-60BK



PDC-930BK



ORGANIZERS

CLEAR COMPARTMENT STORAGE BOXES

Clear Compartment Storage Boxes



Utility boxes offer compartments for small and medium parts storage. Manufactured of clear, see-through polypropylene.

Available in: ● Clear

MODEL NO.	OUTSIDE DIMENSIONS L" x W" x H"	CTN QTY	CTN WGT
Removable Dividers			
QB200	5-1/2" x 2-3/4" x 1-1/4"	12	2 lbs
QB300	6-3/4" x 4-3/4" x 2-1/4"	12	4 lbs
QB400	7-3/4" x 5-1/2" x 1-3/4"	12	5 lbs
QB600	9-1/4" x 6-1/4" x 2-1/5"	6	4 lbs
QB800	11-3/4" x 7-3/4" x 2-1/5"	6	5 lbs
Fixed Dividers			
QB900	10-1/4" x 13" x 2-3/8"	6	8 lbs

To order a full carton add **CS** suffix to Model No. QB200**CS**. Note: Bins must be ordered in carton quantities only.



QB900

- Organizer has 10 fixed compartments



QB200

- Includes 2 fixed and 6 removable dividers creating 3-8 compartments



QB300

- Includes 5 removable dividers creating 1-6 compartments



QB400

- Includes 1 fixed and 6 removable dividers creating 2-8 compartments



QB600

- Includes removable tray and 3 removable dividers creating 1-8 compartments

COMPARTMENTS FOR SMALL AND MEDIUM SIZED PARTS



QB800

- Includes 6 removable dividers creating 1-10 compartments



Organizers



Clear lid design allows quick identification of parts inside. Unique latch design enables lid to close and latch tight and secure. Dividers prevent parts from migrating between various compartments. Organizers manufactured from industrial grade polypropylene.

Available in: ● Black, Red and Clear

MODEL NO.	OUTSIDE DIMENSIONS L" x W" x H"	CTN QTY	CTN WGT
Single Sided			
ORG80032	12-1/2" x 10" x 2-1/4"	6	7 lbs
ORG81532	15" x 12-1/4" x 2-3/4"	6	11 lbs
ORG81832	18" x 14" x 3"	4	10 lbs
Double Sided			
ORG80322	12-1/4" x 10-1/4" x 3"	5	9 lbs

To order a full carton add **CS** suffix to Model No.ORG80032**CS**. Note: Bins must be ordered in carton quantities only.



ORG80032
Single Sided Organizer

- Offers up to 17 storage compartments
- Includes 12 dividers allowing you to customize the size of the desired compartments inside

SINGLE SIDED



ORG81532
Single Sided Organizer

- Offers up to 23 storage compartments
- Includes 18 dividers allowing you to customize the size of the desired compartments inside

SINGLE SIDED



ORG81832
Single Sided Organizer

- Offers up to 26 storage compartments
- Includes 21 dividers allowing you to customize the size of the desired compartments inside

SINGLE SIDED



ORG80322
Double Sided Organizer

- Offers up to 32 storage compartments
- Includes 24 dividers allowing you to customize the size of the desired compartments inside

DOUBLE SIDED



DIVIDERS INCLUDED



Clear Tip Out Bins



**THE ORIGINAL AND
INDUSTRY STANDARD**

Space saving bin units keep small and medium sized parts organized, sorted and easy to find. These clear, break resistant injection molded plastic containers tip open smoothly to a 45° angle and are completely removable for easy access and refilling. Molded handle with slots for labels provided. Bins are easily cleaned with soap and water. Polystyrene cabinet can be stacked or wall mounted. Exterior available in 3 colors. Cups are clear. Optional dividers, locking rod and louvered panel bracket also available.

Available in: ● Ivory ● Gray ○ White

MODEL NO.	OUTSIDE DIMENSIONS L" x W" x H"	CUP DIMENSIONS L" x W" x H"	CTN QTY	CTN WGT
QTB301	11-3/4" x 11-13/16" x 13-7/8"	8-7/8" x 11-1/16" x 13-5/8"	1	7 lbs
QTB302	11-3/4" x 23-5/8" x 13-7/8"	8-7/8" x 11-1/16" x 13-5/8"	1	14 lbs
QTB303	7-3/4" x 23-5/8" x 9-1/2"	5-7/8" x 7-3/8" x 8-5/8"	1	9 lbs
QTB304	6-5/8" x 23-5/8" x 8-1/8"	5" x 5-5/8" x 7-1/2"	1	7 lbs
QTB305	5-1/4" x 23-5/8" x 6-1/2"	3-3/4" x 4-1/4" x 5-3/4"	1	5 lbs
QTB306	3-5/8" x 23-5/8" x 4-1/2"	2-5/8" x 3-1/2" x 3-3/4"	1	2 lbs
QTB309	2-1/2" x 23-5/8" x 3-1/8"	1-3/4" x 2-3/16" x 2-1/2"	1	2 lbs
DIV303	3 Dividers for QTB303		3	2 lbs
DIV304	4 Dividers for QTB304		4	1 lb
QLR500	Locking Rod for 23-5/8"W Tip Out Bins		1	1 lb
QTB-LP-BKT	Louvered Panel Bracket Pair for Tip Out Bins (Sold as a pair)		2	1 lb



DIV303 and DIV304
QTB303 and QTB304
cup can use optional divider, as shown.



QTB-LP-BKT
Louvered Panel Bracket
Hang 23-5/8"W bin on louvered panel using bracket. Available in Beige or Gray. Panels available on pg. 76.



QLR500
Locking Rod
Keeps bins from tilting open. Can be used with 23-5/8"W bins.

TIP OUT BIN CLEAR COMPARTMENTS KEEP SMALL ITEMS SORTED AND EASY TO FIND



QTB309



QTB306



QTB305



QTB304



QTB309

QTB306

QTB303



QTB305

QTB302



QTB304

QTB303

**TIP OUT
BIN**

QTB301



CLEAR TIP OUT BIN SYSTEMS CAN BE USED IN ANY APPLICATION

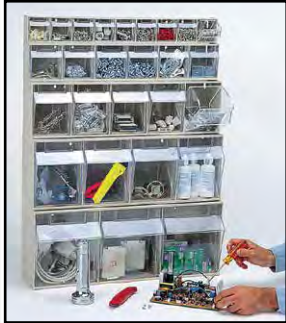

INDUSTRIAL, MECHANICAL AND PLUMBING SUPPLIES

Very handy for the garage, tool shed, service vehicle, factory, hardware and home center facilities.



MEDICAL

Very efficient when it comes to organizing and keeping an effective inventory in hospitals, pharmacies, labs or clinics.



PLAYROOM

The smartest organizer after a hard day's play. It will help keep your child's room in order.

Individual Tip Out Bins



These unique bins have the ability to interlock horizontally or vertically. Available in three popular sizes, these bins allow you to create your own customized Tip Out Bin storage system perfect for color coding.

QTB405 and QTB406 available in: Ivory Gray White
QTB409 available in: Blue Red Yellow White

MODEL NO.	OUTSIDE DIMENSIONS L" x W" x H"	CTN QTY	CTN WGT
QTB405	5-1/4" x 4-3/4" x 6-1/4"	5	6 lbs
QTB406	3-5/8" x 4-1/16" x 4-1/4"	6	4 lbs
QTB409	2-3/8" x 2-13/16" x 3"	9	3 lbs

To order a full carton add CS suffix to Model No. QTB405BLCS. Note: Bins must be ordered in carton quantities only.



BINS INTERLOCK

VERTICALLY

AND

HORIZONTALLY



QTB409



QTB406



QTB405

Dividable Tip Out Bins



These bins feature removable and adjustable dividers so that the clear bin can be partitioned into smaller compartments. Ideal for larger or longer items, these clear Tip Out Bins are molded from the same strong and flexible material as our standard bins. The flexibility of bins allow the user to determine the size and volume of each storage compartment. Exterior available in 3 colors. Cups are clear.

Available in: Ivory Gray White

MODEL NO.	OUTSIDE DIMENSIONS L" x W" x H"	CTN QTY	CTN WGT
QTB410	5-1/4" x 11-7/8" x 5-15/16"	1	3 lbs
DIV400	Divider for Dividable Tip Out Bins	4	1 lb

PERFORMANCE FEATURES:

- Bins can be stacked as modular units or used individually
- Exterior housing is injection molded from high impact Polystyrene
- Clear bin cups are injection molded from a custom blend of Phillips K Resin and Crystal Styrene for clarity and durability
- Compartments tip open smoothly to a 45° angle and provide comfortable and complete access to stored items
- The flexibility of the system allows you to customize your own system to meet your specific needs



QTB410 is a one bin design, 12" wide. Each QTB410 comes with 3 DIV400 clear dividers*

*Note: Dividers shown in white color for clarity

TIP OUT BIN

21 Compartment Tip Out Bin Set



- 21 clear cups inside one unit
- Clear cups with blue handles

Available in: Gray

MODEL NO.	OUTSIDE DIMENSIONS L" x W" x H"	CUP DIMENSIONS L" x W" x H"	CUP QTY	PKG QTY	PKG WGT
QTB669	3-5/8" x 23-5/8" x 11-1/6"	2-5/8" x 3-1/2" x 3-3/4" 1-3/4" x 2-3/16" x 2-1/2"	12 9	4	24 lbs



QTB669



***Prices subject to change without notice.**



MODEL NO. PG.	2424P - 2472P..... 24	AD54-3636GY - AD54-3672GY-5..... 26	AD86-1424P - AD86-1472P-5..... 29	DS18-24..... 30, 77
1006DHB - 1006DHB-SQ..... 74	2424S - 2472S..... 24	AD54-3636P - AD54-3672P-5..... 26	AD86-1430S - AD86-1472S-5..... 29	DS91025 - DS93120..... 123
1017HBC - 1047HBC..... 74, 75	2424SG - 2472SG..... 37	AD54-3636S - AD54-3672S-5..... 26	AD86-1436SG - AD86-1472SG..... 38	DSB101 - DSB118/122..... 114
1224BK - 1272BK..... 24	2424SS - 2472SS..... 37	AD63-1236BK - AD63-1272BK-5..... 27	AD86-1436SG-5 - AD86-1472SG-5..... 39	DSB201 - DSB218/222..... 117
1224C - 1272C..... 24	2424WPM - 2472WPM..... 20	AD63-1236C - AD63-1272C-5..... 27	AD86-1824BK - AD86-1872BK-5..... 29	DSB801 - DSB816..... 119
1224GY - 1727GY..... 24	2424WPMS - 2472WPMS..... 20	AD63-1236GY - AD63-1272GY-5..... 27	AD86-1824C - AD86-1872C-5..... 29	DSK18 - DSK24..... 58
1224P - 1272P..... 24	243034DGY - 243054DGY..... 73	AD63-1236P - AD63-1272P-5..... 27	AD86-1824GY - AD86-1872GY-5..... 29	DSS401 - DSS405..... 100
1224RCGBK - 1260RCGBK..... 52	2430SSTOP - 3072SSTOP..... 69	AD63-1236S - AD63-1272S-5..... 27	AD86-1824P - AD86-1872P-5..... 29	DUS210 - DUS270..... 93
1224RCSGY - 1260RCSGY..... 52	243614PC - 243614PP..... 72	AD63-1424BK - AD63-1472BK-5..... 27	AD86-1824S - AD86-1872S-5..... 29	DWB12 - DWB24P..... 65
1224RCSP - 1260RCSP..... 52	243634DGY - 243654DGY..... 73	AD63-1424C - AD63-1472C-5..... 27	AD86-1836SG - AD86-1872SG..... 38	DWBD12 - DWBD24P..... 65
1236S - 1272S..... 52	243660EPC - 243660EPP..... 50	AD63-1424GY - AD63-1472GY-5..... 27	AD86-1836SG-5 - AD86-1872SG-5..... 39	E
1275-423 - 1275-445..... 101	2436-63SEC - 2436-63SECP-2..... 50	AD63-1424P - AD63-1472P-5..... 27	AD86-2124BK - AD86-2172BK-5..... 29	EL-12406..... 71
1424BK - 1472BK..... 24	2436COV..... 34	AD63-1430S - AD63-1472S-5..... 27	AD86-2124C - AD86-2172C-5..... 29	ELH410 - ELH445..... 114, 117
1424C - 1472C..... 24	2436FC - 2460FC..... 53	AD63-1436SG - AD63-1472SG..... 38	AD86-2124GY - AD86-2172GY-5..... 29	EP126 - EP228S..... 30
1424GY - 1472GY..... 24	2436FP - 2460FP..... 53	AD63-1436SG-5 - AD63-1472SG-5..... 39	AD86-2124P - AD86-2172P-5..... 29	EP126-CUT - EP228S-CUT..... 30
1424P - 1472P..... 24	2436FS - 2460FS..... 53	AD63-1824BK - AD63-1872BK-5..... 27	AD86-2124S - AD86-2172S-5..... 29	EP-CLIP..... 30
1424WPM - 1472WPM..... 20	2436SL - 2448SL..... 53	AD63-1824C - AD63-1872C-5..... 27	AD86-2136SG - AD86-2172SG..... 38	F
1424WPMS - 1472WPMS..... 20	2436SL6C - 2448SL6C..... 78	AD63-1824GY - AD63-1872GY-5..... 27	AD86-2136SG-5 - AD86-2172SG-5..... 39	FG..... 20, 23, 32
1430S - 1472S..... 24	2436SM..... 73	AD63-1824P - AD63-1872P-5..... 27	AD86-2424BK - AD86-2472BK-5..... 29	FP..... 20, 23, 32
1430SS - 1472SS..... 37	244234DGY - 244254DGY..... 73	AD63-1824S - AD63-1872S-5..... 27	AD86-2424C - AD86-2472C-5..... 29	FSB-1295..... 87
1436-74BWSEC - 1436-74MIXSECBK..... 81	2442CRNC - 2442CRNP..... 51	AD63-1836SG - AD63-1872SG..... 38	AD86-2424GY - AD86-2472GY-5..... 29	FSB-1544..... 87
1436BC - 1448BC..... 66	244814PC - 244814PP..... 72	AD63-1836SG-5 - AD63-1872SG-5..... 39	AD86-2424P - AD86-2472P-5..... 29	FSB-20113..... 87
1436SG - 1472SG..... 37	244834DGY - 244854DGY..... 73	AD63-2124BK - AD63-2172BK-5..... 27	AD86-2424S - AD86-2472S-5..... 29	FSB-20155..... 87
1436WSBK - 1448WSBK..... 80	244860EPC - 244860EPP..... 50	AD63-2124C - AD63-2172C-5..... 27	AD86-2436SG - AD86-2472SG..... 38	FSB-20155R..... 87
1436WSC - 1448WSC..... 80	2448-63SEC - 2448-63SECP-2..... 50	AD63-2124GY - AD63-2172GY-5..... 27	AD86-2436SG-5 - AD86-2472SG-5..... 39	FSB-21155..... 87
1448-74BWSEC - 1448-74MIXSECBK..... 81	2448COV..... 34	AD63-2124P - AD63-2172P-5..... 27	AD86-3036BK - AD86-3072BK-5..... 29	FSB-21155R..... 87
1606DHB - 1606DHB-SQ..... 74	2448SM..... 34	AD63-2124S - AD63-2172S-5..... 27	AD86-3036C - AD86-3072C-5..... 29	FSB-21157..... 87
1617HBC - 1647HBC..... 74, 75	246014PC - 246014PP..... 72	AD63-2136SG - AD63-2172SG..... 38	AD86-3036GY - AD86-3072GY-5..... 29	FSB-21157R..... 87
182414DGY - 186014DGY..... 72	246034DGY - 246054DGY..... 73	AD63-2136SG-5 - AD63-2172SG-5..... 39	AD86-3036P - AD86-3072P-5..... 29	FSB-21165..... 87
182434DGY - 182454DGY..... 73	246060EPC - 246060EPP..... 50	AD63-2424BK - AD63-2472BK-5..... 27	AD86-3036S - AD86-3072S-5..... 29	FSB-22175..... 87
1824BK - 1872BK..... 24	2460-63SEC - 2460-63SECP-2..... 50	AD63-2424C - AD63-2472C-5..... 27	AD86-3636BK - AD86-3672BK-5..... 29	FSB-22177R..... 87
1824C - 1872C..... 24	2460-63SECP - 2460-63SECP-2..... 50	AD63-2424GY - AD63-2472GY-5..... 27	AD86-3636C - AD86-3672C-5..... 29	FSB-DT1813..... 84
1824DSGY - 2460DSGY..... 52	2460CHD..... 24	AD63-2424P - AD63-2472P-5..... 27	AD86-3636GY - AD86-3672GY-5..... 29	FSB-DT18133..... 84
1824FGY - 1860FGY..... 53	2460COV..... 34	AD63-2424S - AD63-2472S-5..... 27	AD86-3636P - AD86-3672P-5..... 29	FSB-L2016..... 87
1824GY - 1872GY..... 24	2460SM..... 34	AD63-2436SG - AD63-2472SG..... 38	AD86-3636S - AD86-3672S-5..... 29	FSB-L2015..... 87
1824P - 1872P..... 24	2472CHD..... 24	AD63-2436SG-5 - AD63-2472SG-5..... 39	AL-23 - AL-35..... 128	FSB-L2157R..... 87
1824S - 1872S..... 24	2472COV..... 34	AD63-3036BK - AD63-3072BK-5..... 27	B	FSB-L216..... 87
1824SG - 1872SG..... 37	2472SM..... 34	AD63-3036C - AD63-3072C-5..... 27	BC212434M1..... 77	FSB-L2217..... 87
1824SS - 1872SS..... 20	2475-483 - 2475-485..... 101	AD63-3036GY - AD63-3072GY-5..... 27	BC212439M7..... 77	FSB-MD3LP3L..... 84
1824WPM - 1872WPM..... 20	248H - 60BH..... 53	AD63-3036P - AD63-3072P-5..... 27	BC212469M - BC212469M11..... 77	FSB-PL2618..... 84
1824WPMS - 1872WPMS..... 20	3030GY - 3072GY..... 24	AD63-3036S - AD63-3072S-5..... 27	BL36 - BL72S..... 31	FSB-PT26183..... 84
1824ESD - 1848ESD..... 86	3036BK - 3072BK..... 24	AD63-3636BK - AD63-3672BK-5..... 27	BLH3C - BLH56C..... 85	FSB-PT26186..... 84
183034DGY - 183054DGY..... 73	3036C - 3072C..... 24	AD63-3636C - AD63-3672C-5..... 27	BSK1824C - BSK2460C..... 58	FSB-PTDLY..... 84
183614PC - 183614PP..... 72	3036P - 3072P..... 24	AD63-3636GY - AD63-3672GY-5..... 27	C	
183634DGY - 183654DGY..... 73	3036S - 3072S..... 24	AD63-3636P - AD63-3672P-5..... 27	CAN-34-1436BC-PWB -	
183660EPC - 183660EPP..... 50	362412DPP - 363612DPS..... 71, 124	AD63-3636S - AD63-3672S-5..... 27	CAN-34-204812BC-PWB..... 66	
1836-63SEC - 1836-63SECP-2..... 50	3636BK - 363672BK..... 24	AD74-1236BK - AD74-1272BK-5..... 28	CB12 - CB24P..... 65	H
1836COV..... 34	3636C - 363672C..... 24	AD74-1236C - AD74-1272C-5..... 28	CC183663 - CC187274..... 46	HANDLE-DLY..... 85, 92
1836CRNC - 1836CRNP..... 51	3636GY - 363672GY..... 24	AD74-1236GY - AD74-1272GY-5..... 28	CC243663 - CC247274..... 46	HB14C - HB60S..... 30
1836DS - 2460DS..... 52	3636P - 363672P..... 24	AD74-1236P - AD74-1272P-5..... 28	CD965 - CD1887..... 121	HBL165C - HBL465C..... 35, 74, 76
1836FC - 1860FC..... 53	3636S - 363672S..... 24	AD74-1236S - AD74-1272S-5..... 28	COV210 - COV248..... 93	HBL3C..... 35, 76, 98
1836FP - 1860FP..... 53	482412DPP - 482412DPS..... 71, 124	AD74-1424BK - AD74-1472BK-5..... 28	COV91000 - COV93000..... 123	HD18 - HD36..... 56
1836FS - 1860FS..... 53	4X3HBD - 4X15HBD..... 53	AD74-1424C - AD74-1472C-5..... 28	CR2436Y..... 23	HD18-2 - HD36-3..... 57
1836SL - 1848SL..... 53	52RT - 84RT..... 43	AD74-1424GY - AD74-1472GY-5..... 28	CRDUS238 - CRDUS270..... 93	HD18-2DR - HD36-3DR..... 57
1836SL6C - 1848SL6C..... 78	662412DPP - 663612DPS..... 71, 124	AD74-1424P - AD74-1472P-5..... 28	CRDUS957..... 102	HMB510C - HMB565C..... 98
1836SM..... 74	962412DPP - 963612DPS..... 71, 124	AD74-1430S - AD74-1472S-5..... 28	CT27-1824GY-230 - CT27-1836GY-230..... 83	K
184234DGY - 184254DGY..... 73	A	AD74-1436SG - AD74-1472SG..... 38	D	KEYBOARD..... 30
184814PC - 184814PP..... 72	AD54-1236BK - AD54-1272BK-5..... 26	AD74-1436SG-5 - AD74-1472SG-5..... 39	DB..... 33	L
184834DGY - 184854DGY..... 73	AD54-1236C - AD54-1272C-5..... 26	AD74-1824BK - AD74-1872BK-5..... 28	DB1836C - DB2460S..... 30	LBL2X8 - LBL5X8..... 123, 128
184860EPC - 184860EPP..... 50	AD54-1236GY - AD54-1272GY-5..... 26	AD74-1824C - AD74-1872C-5..... 28	DC191507..... 122	LBL2X8CO - LBL5X8CO..... 128
1848-63SEC - 1848-63SECP-2..... 50	AD54-1236P - AD54-1272P-5..... 26	AD74-1824GY - AD74-1872GY-5..... 28	DCB12 - DCB24P..... 65	LC191507..... 122
1848COV..... 34	AD54-1236S - AD54-1272S-5..... 26	AD74-1824P - AD74-1872P-5..... 28	DDC91000CL - DDC93000CL..... 123	LD965 - LD1887..... 121
1848SM..... 34	AD54-1424BK - AD54-1472BK-5..... 26	AD74-1824S - AD74-1872S-5..... 28	DDC91000CL - DDC93000CL..... 123	LDSB118 - LDSB122..... 114
186014PC - 186014PP..... 72	AD54-1424C - AD54-1472C-5..... 26	AD74-1836SG - AD74-1872SG..... 38	DDS-24..... 30	LDSB218 - LDSB222..... 117
186034DGY - 186054DGY..... 73	AD54-1424GY - AD54-1472GY-5..... 26	AD74-1836SG-5 - AD74-1872SG-5..... 39	DG91025..... 123	LH3B - LH69C..... 35
186060EPC - 186060EPP..... 50	AD54-1424P - AD54-1472P-5..... 26	AD74-2124BK - AD74-2172BK-5..... 28	DG91035..... 123	LHA3C - LHA24C..... 35
1860-63SEC - 1860-63SECP-2..... 50	AD54-1430S - AD54-1472S-5..... 26	AD74-2124C - AD74-2172C-5..... 28	DG91050..... 123	LHE3XS..... 35
1860COV..... 34	AD54-1436SG - AD54-1472SG..... 38	AD74-2124GY - AD74-2172GY-5..... 28	DG92035..... 78, 123	LH1-3 - LH1-6..... 35
1860SM..... 34	AD54-1436SG-5 - AD54-1472SG-5..... 39	AD74-2124P - AD74-2172P-5..... 28	DG92050..... 123	LH1-12..... 126
1872COV..... 34	AD54-1824BK - AD54-1872BK-5..... 26	AD74-2124S - AD74-2172S-5..... 28	DG92060..... 78, 123	LID1711..... 85
1872SM..... 34	AD54-1824C - AD54-1872C-5..... 26	AD74-2136SG - AD74-2172SG..... 38	DG92080..... 78, 123	LID181 - LID301..... 124
1875-461 - 1875-465..... 101	AD54-1824GY - AD54-1872GY-5..... 26	AD74-2136SG-5 - AD74-2172SG-5..... 39	DG93000..... 123, 125	LID1915..... 122
187B - 36TB..... 31	AD54-1824P - AD54-1872P-5..... 26	AD74-2424BK - AD74-2472BK-5..... 28	DG93060..... 77, 123	LID2415..... 126
2026ESD - 2026TR..... 86	AD54-1824S - AD54-1872S-5..... 26	AD74-2424C - AD74-2472C-5..... 28	DG93080..... 123	LID2417..... 85
203612BC - 204812BC..... 66	AD54-1836SG - AD54-1872SG..... 38	AD74-2424GY - AD74-2472GY-5..... 28	DG93120..... 123	LID2516-8..... 85
2036BC - 2048BC..... 66	AD54-1836SG-5 - AD54-1872SG-5..... 39	AD74-2424P - AD74-2472P-5..... 28	DH8..... 34	LID-4845..... 107
2124BK - 2472BK..... 24	AD54-2124BK - AD54-2172BK-5..... 26	AD74-2424S - AD74-2472S-5..... 28	DIV12 - DIV36..... 31	LTR-0813..... 114, 128
2124C - 2472C..... 24	AD54-2124C - AD54-2172C-5..... 26	AD74-2436SG - AD74-2472SG..... 38	DIV12BK - DIV36BK..... 31	LTR-1253..... 93, 128
2124GY - 2472GY..... 24	AD54-2124GY - AD54-2172GY-5..... 26	AD74-2436SG-5 - AD74-2472SG-5..... 39	DIV26K - DIV36GY..... 31	LTR-1300..... 93, 128
2124P - 2472P..... 24	AD54-2124P - AD54-2172P-5..... 26	AD74-3036BK - AD74-3072BK-5..... 28	DIV12P - DIV36P..... 31	LTR-1754..... 93, 128
2124S - 2472S..... 24	AD54-2124S - AD54-2172S-5..... 26	AD74-3036C - AD74-3072C-5..... 28	DIV21S - DIV36S..... 31	LTR-2400..... 93, 128
2124SG - 2172SG..... 37	AD54-2136SG - AD54-2172SG..... 38	AD74-3036GY - AD74-3072GY-5..... 28	DIV18SL - DIV24SL..... 53	LTR-700..... 110, 128
2124SS - 2172SS..... 37	AD54-2136SG-5 - AD54-2172SG-5..... 39	AD74-3036P - AD74-3072P-5..... 28	DNV24X21GY..... 31	M
2124WPM - 2172WPM..... 20	AD54-2424BK - AD54-2472BK-5..... 26	AD74-3036S - AD74-3072S-5..... 28	DNV24X3SW..... 31	M1436-69BWSEC - M1448-69BWSECBK..... 81
2124WPMS - 2172WPMS..... 20	AD54-2424C - AD54-2472C-5..... 26	AD74-3636BK - AD74-3672BK-5..... 28	DNV24X6..... 31	M1436-69MIXSEC - M1448-69MIXSECBK..... 81
213660EPC - 213660EPP..... 50	AD54-2424GY - AD54-2472GY-5..... 26	AD74-3636C - AD74-3672C-5..... 28	DNV303 - DIV304..... 132	M182460GY - M186060GY..... 72
2136-63SEC - 2136-63SECP-2..... 50	AD54-2424P - AD54-2472P-5..... 26	AD74-3636GY - AD74-3672GY-5..... 28	DNV304..... 132	M1836-69SEC - M1836-69SEC-2..... 50
214860EPC - 214860EPP..... 50	AD54-2424S - AD54-2472S-5..... 26	AD74-3636P - AD74-3672P-5..... 28	DNV401..... 97	M1836-69SECP - M1836-69SECP-2..... 50
2148-63SEC - 2148-63SECP-2..... 50	AD54-2436SG - AD54-2472SG..... 38	AD74-3636S - AD74-3672S-5..... 28	DNV501/604..... 97	M1836BK46 - M1860BK46-5..... 42
2148FSGY - 2160FSGY..... 53	AD54-2436SG-5 - AD54-2472SG-5..... 39	AD86-1236BK - AD86-1272BK-5..... 29	DNV6123..... 97	M1836BK47 - M1860BK47-5..... 42
216060EPC - 216060EPP..... 50	AD54-3036BK - AD54-3072BK-5..... 26	AD86-1236C - AD86-1272C-5..... 29	DNV701/606..... 97	M1836C46 - M1860C46-5..... 42
2160-63SEC - 2160-63SECP-2..... 50	AD54-3036C - AD54-3072C-5..... 26	AD86-1236GY - AD86-1272GY-5..... 29	DL91025 - DL93120..... 123	M1836C46RE - M1860C46RE-5..... 43
242414DGY - 246014DGY..... 72	AD54-3036GY - AD54-3072GY-5..... 26	AD86-1236P - AD86-1272P-5..... 29	DLT-6..... 128	M1836C47RE - M1860C47RE-5..... 43
2424BK - 2472BK..... 24				



M1836GY46 - M1860GY46-5	42	P86GY	25	QP184262V3S1 - QP184262V4S1	15	QP2136SS - QP2136VS	12	QP243686VS-4 - QP243686VS-5	13
M1836GY47 - M1860GY47-5	42	P86P	20, 25	QP184262VS-4 - QP184262VS-5	13	QP214250SS-4 - QP214250SS-5	14	QP2436SS - QP2436VS	12
M1836P46 - M1860P46-5	42	P86S	25, 37	QP184274SS-4 - QP184274SS-5	14	QP214250VS-4 - QP214250VS-5	13	QP244250SS-4 - QP244250SS-5	14
M1836P47 - M1860P47-5	42	P96BK	25	QP184274V3S1 - QP184274V4S1	15	QP214262SS-4 - QP214262SS-5	14	QP244250VS-4 - QP244250VS-5	13
M1836SG46 - M1860SG46-5	45	P96C	25, 37	QP184274VS-4 - QP184274VS-5	13	QP214262V3S1 - QP214262V4S1	15	QP244262SS-4 - QP244262SS-5	14
M1836SG47 - M1860SG47-5	45	P96GY	25	QP184286SS-4 - QP184286SS-5	14	QP214262VS-4 - QP214262VS-5	13	QP244262V3S1 - QP244262V4S1	15
M1836SL34C	78	P96P	20, 25	QP184286VS-4 - QP184286VS-5	13	QP214274SS-4 - QP214274SS-5	14	QP244262VS-4 - QP244262VS-5	13
M1836SL6C	78	P96S	25, 37	QP184286V3S1 - QP184286V4S1	15	QP214274V3S1 - QP214274V4S1	15	QP244274SS-4 - QP244274SS-5	14
M1836SS46 - M1860SS46-5	42	PC3518-33 - PC3518-33-3	89	QP1842S - QP1842VS	12	QP214274VS-4 - QP214274VS-5	13	QP244274V3S1 - QP244274V4S1	15
M1836SS47 - M1860SS47-5	42	PC3518SHELF	89	QP184814SP - QP184814VP	17	QP214286SS-4 - QP214286SS-5	14	QP244274VS-4 - QP244274VS-5	13
M1848SL34C	78	PC4026-33 - PC4026-33-3	89	QP184850VS-4 - QP184850VS-5	14	QP214286V3S1 - QP214286V4S1	15	QP244286SS-4 - QP244286SS-5	14
M1848SL6C	78	PC4026SHELF	89	QP184850VS-4 - QP184850VS-5	13	QP214286VS-4 - QP214286VS-5	13	QP244286V3S1 - QP244286V4S1	15
M24246DGY - M2460DGY	72	PC-CAS-RG	89	QP184862SS-4 - QP184862SS-5	14	QP2142SS - QP2142VS	12	QP244286VS-4 - QP244286VS-5	13
M2436BK46 - M2460BK46-5	42	PC-CAS-SW	89	QP184862V3S1 - QP184862V4S1	15	QP214850SS-4 - QP214850SS-5	14	QP2442F	18
M2436BK47 - M2460BK47-5	42	PCL1 - PCL2	31	QP184862VS-4 - QP184862VS-5	13	QP214850VS-4 - QP214850VS-5	13	QP2442SS - QP2442VS	12
M2436C46 - M2460C46-5	42	PDC-12BK - PDC-930BK	129	QP184874VS-4 - QP184874VS-5	14	QP214862SS-4 - QP214862SS-5	14	QP244814SP - QP244814VP	17
M2436C46E - M2460C46E-5	45	PFTCA026-33-2 - PFTCA026-33-3	89	QP184874V3S1 - QP184874V4S1	15	QP214862V3S1 - QP214862V4S1	15	QP244850SS-4 - QP244850SS-5	14
M2436C46RE - M2460C46RE-5	43	PH18 - PH36S	31	QP184874VS-4 - QP184874VS-5	13	QP214862VS-4 - QP214862VS-5	13	QP244850VS-4 - QP244850VS-5	13
M2436C47 - M2460C47-5	42	PLH1X6C - PLH2X4C	25, 37	QP184886SS-4 - QP184886SS-5	14	QP214874SS-4 - QP214874SS-5	14	QP244862SS-4 - QP244862SS-5	14
M2436C47RE - M2460C47RE-5	43	PSC-5S	33	QP184886V3S1 - QP184886V4S1	15	QP214874V3S1 - QP214874V4S1	15	QP244862V3S1 - QP244862V4S1	15
M2436CG46 - M2460CG46-5	42	PS-LH3	35, 98	QP184886VS-4 - QP184886VS-5	13	QP214874VS-4 - QP214874VS-5	13	QP244862VS-4 - QP244862VS-5	13
M2436CG46E - M2460CG46E-5	44	PT-NR	33	QP1848SS - QP1848VS	12	QP214886SS-4 - QP214886SS-5	14	QP244874SS-4 - QP244874SS-5	14
M2436CG47 - M2460CG47-5	42	PT-NS	33	QP185450SS-4 - QP185450SS-5	14	QP214886V3S1 - QP214886V4S1	15	QP244874V3S1 - QP244874V4S1	15
M2436CG47RE - M2460CG47RE-5	44	PT-PR	33	QP185450VS-4 - QP185450VS-5	13	QP214886VS-4 - QP214886VS-5	13	QP244874VS-4 - QP244874VS-5	13
M2436GY46 - M2460GY46-5	42	PT-PR6	33	QP185462SS-4 - QP185462SS-5	14	QP2148SS - QP2148VS	12	QP244886SS-4 - QP244886SS-5	14
M2436GY47 - M2460GY47-5	42	PT-PR-S	33	QP185462V3S1 - QP185462V4S1	15	QP215450SS-4 - QP215450SS-5	14	QP244886V3S1 - QP244886V4S1	15
M2436P46 - M2460P46-5	42	PT-PS	33	QP185462VS-4 - QP185462VS-5	13	QP215450VS-4 - QP215450VS-5	13	QP244886VS-4 - QP244886VS-5	13
M2436P46E - M2460P46E-5	45	PT-PS6	33	QP185474SS-4 - QP185474SS-5	14	QP215462SS-4 - QP215462SS-5	14	QP2448SS - QP2448VS	12
M2436P47 - M2460P47-5	42	PT-PSB	33	QP185474V3S1 - QP185474V4S1	15	QP215462V3S1 - QP215462V4S1	15	QP245450SS-4 - QP245450SS-5	14
M2436SG46 - M2460SG46-5	45	PT-PSB6	33	QP185474VS-4 - QP185474VS-5	13	QP215462VS-4 - QP215462VS-5	13	QP245450VS-4 - QP245450VS-5	13
M2436SG47 - M2460SG47-5	45	PT-PSB-S	33	QP185486SS-4 - QP185486SS-5	14	QP215474SS-4 - QP215474SS-5	14	QP245462SS-4 - QP245462SS-5	14
M2436SL34C	78	PT-PS-S	33	QP185486V3S1 - QP185486V4S1	15	QP215474V3S1 - QP215474V4S1	15	QP245462V3S1 - QP245462V4S1	15
M2436SL6C	78	PWB	65	QP185486VS-4 - QP185486VS-5	13	QP215474VS-4 - QP215474VS-5	13	QP245462VS-4 - QP245462VS-5	13
M2436SS46 - M2460SS46-5	42	Q		QP1854SS - QP1854VS	12	QP215486SS-4 - QP215486SS-5	14	QP245474SS-4 - QP245474SS-5	14
M2436SS47 - M2460SS47-5	42	QAT	43	QP186014SP - QP186014VP	17	QP215486V3S1 - QP215486V4S1	15	QP245474V3S1 - QP245474V4S1	15
M2436W46DR	22, 90	QB200 - QB900	130	QP186050SS-4 - QP186050SS-5	14	QP215486VS-4 - QP215486VS-5	13	QP245474VS-4 - QP245474VS-5	13
M2448SL34C	78	QBB - 4845-34	107	QP186050VS-4 - QP186050VS-5	13	QP2154SS - QP2154VS	12	QP245486SS-4 - QP245486SS-5	14
M2448SL6C	78	QBC111 - QBC112	114, 117	QP186062SS-4 - QP186062SS-5	14	QP216050SS-4 - QP216050SS-5	14	QP245486V3S1 - QP245486V4S1	15
M2448W46DR	22, 90	QBRK	56	QP186062V3S1 - QP186062V4S1	15	QP216050VS-4 - QP216050VS-5	13	QP245486VS-4 - QP245486VS-5	13
M2460W46DR	22, 90	QDC2012-7 - QDC2820-15	127	QP186062VS-4 - QP186062VS-5	13	QP216062SS-4 - QP216062SS-5	14	QP2454F	18
MD1836-70SEC - MD2460-70SEC-2	50	QDL-2115	127	QP186074SS-4 - QP186074SS-5	14	QP216062V3S1 - QP216062V4S1	15	QP2454SS - QP2454VS	12
MD1836-70SECP - MD2460-70SECP-2	50	QED401 - QED801	127	QP186074VS-4 - QP186074VS-5	13	QP216062VS-4 - QP216062VS-5	13	QP246014SP - QP246014VP	17
MD1836C46RE - MD1860C46RE-5	43	QESTP	56	QP186074VS-4 - QP186074VS-5	13	QP216074SS-4 - QP216074SS-5	14	QP246050SS-4 - QP246050SS-5	14
MD1836C47RE - MD1860C47RE-5	43	QFSD-2236 - QFSD-2260	70	QP186086SS-4 - QP186086SS-5	14	QP216074V3S1 - QP216074V4S1	15	QP246050VS-4 - QP246050VS-5	13
MD1836C46RE - MD1860C46RE-5	44	QGH600	110, 111	QP186086V3S1 - QP186086V4S1	15	QP216074VS-4 - QP216074VS-5	13	QP246062SS-4 - QP246062SS-5	14
MD1836C47RE - MD1860C47RE-5	44	QGH700	110, 111	QP186086VS-4 - QP186086VS-5	13	QP216086SS-4 - QP216086SS-5	14	QP246062V3S1 - QP246062V4S1	15
MD2436C46RE - MD2460C46RE-5	43	QGH705MOB	110	QP1860SS - QP1860VS	12	QP216086V3S1 - QP216086V4S1	15	QP246062VS-4 - QP246062VS-5	13
MD2436C47RE - MD2460C47RE-5	43	QGH800	110	QP1867	121	QP216086VS-4 - QP216086VS-5	13	QP246074SS-4 - QP246074SS-5	14
MD2436C46RE - MD2460C46RE-5	44	QGH805MOB	110	QP187250SS-4 - QP187250SS-5	13	QP2160SS - QP2160VS	12	QP246074V3S1 - QP246074V4S1	15
MD2436C47RE - MD2460C47RE-5	44	QLP-1861HC - QLP-4861HC	75, 76	QP187250VS-4 - QP187250VS-5	13	QP217250SS-4 - QP217250SS-5	14	QP246074VS-4 - QP246074VS-5	13
MWR4-2419-9	125	QLR500	132	QP187262SS-4 - QP187262SS-5	14	QP217250VS-4 - QP217250VS-5	13	QP246086SS-4 - QP246086SS-5	14
MWR5-1711-12	125	QMB510C - QMB570C	98	QP187262V3S1 - QP187262V4S1	15	QP217262SS-4 - QP217262SS-5	14	QP246086V3S1 - QP246086V4S1	15
MWR7-1711-8	125	QMS531 - QMS843MOB	112	QP187262VS-4 - QP187262VS-5	13	QP217262V3S1 - QP217262V4S1	15	QP246086VS-4 - QP246086VS-5	13
MWR5-5-92035 - MWR5-5-92080	78	QP965	121	QP187274SS-4 - QP187274SS-5	14	QP217262VS-4 - QP217262VS-5	13	QP2460SS - QP2460VS	12
MWR5-7-103 - MWR5-7-110	78	QP1265	121	QP187274V3S1 - QP187274V4S1	15	QP217274SS-4 - QP217274SS-5	14	QP247250SS-4 - QP247250SS-5	14
MWR5-7-602 - MWR5-7-606	78	QP1285	121	QP187274VS-4 - QP187274VS-5	13	QP217274V3S1 - QP217274V4S1	15	QP247250VS-4 - QP247250VS-5	13
N		QP1496	121	QP187286SS-4 - QP187286SS-5	14	QP217274VS-4 - QP217274VS-5	13	QP247262SS-4 - QP247262SS-5	14
NP1076	91	QP182450SS-4 - QP182450SS-5	13	QP187286V3S1 - QP187286V4S1	15	QP217286SS-4 - QP217286SS-5	14	QP247262V3S1 - QP247262V4S1	15
O		QP182450VS-4 - QP182450VS-5	13	QP187286VS-4 - QP187286VS-5	13	QP217286V3S1 - QP217286V4S1	15	QP247262VS-4 - QP247262VS-5	13
ORG80032 - ORG81832	131	QP182462SS-4 - QP182462SS-5	14	QP1872SS	12	QP217286VS-4 - QP217286VS-5	13	QP247274SS-4 - QP247274SS-5	14
P		QP182462V3S1 - QP182462V4S1	15	QP1872VS	12	QP2172SS - QP2172VS	12	QP247274V3S1 - QP247274V4S1	15
P6BK	25	QP182462VS-4 - QP182462VS-5	13	QP1887	121	QP242450SS-4 - QP242450SS-5	14	QP247274VS-4 - QP247274VS-5	13
P6C	25, 37	QP182474SS-4 - QP182474SS-5	14	QP212450SS-4 - QP212450SS-5	14	QP242450VS-4 - QP242450VS-5	13	QP247286SS-4 - QP247286SS-5	14
P6GY	25	QP182474V3S1 - QP182474V4S1	15	QP212450VS-4 - QP212450VS-5	13	QP242462SS-4 - QP242462SS-5	14	QP247286V3S1 - QP247286V4S1	15
P6S	20, 25	QP182474VS-4 - QP182474VS-5	13	QP212462SS-4 - QP212462SS-5	14	QP242462V3S1 - QP242462V4S1	15	QP247286VS-4 - QP247286VS-5	13
P6S	25, 37	QP182486SS-4 - QP182486SS-5	14	QP212462V3S1 - QP212462V4S1	15	QP242462VS-4 - QP242462VS-5	13	QP2472SS - QP2472VS	12
P14BK	25	QP182486V3S1 - QP182486V4S1	15	QP212462VS-4 - QP212462VS-5	13	QP242474SS-4 - QP242474SS-5	14	QP-AD	16
P14C	25, 37	QP182486VS-4 - QP182486VS-5	13	QP212474SS-4 - QP212474SS-5	14	QP242474V3S1 - QP242474V4S1	15	QP-DW18 - QP-DW24	16
P14GY	25	QP1824SS - QP1824VS	12	QP212474V3S1 - QP212474V4S1	15	QP242474VS-4 - QP242474VS-5	13	QPDR1 - QPDR2	18
P14P	20, 25	QP183050SS-4 - QP183050SS-5	13	QP212474VS-4 - QP212474VS-5	13	QP242486SS-4 - QP242486SS-5	14	QFDS	17
P14S	25, 37	QP183050VS-4 - QP183050VS-5	13	QP212486SS-4 - QP212486SS-5	14	QP242486V3S1 - QP242486V4S1	15	QFA	12
P34BK	25	QP183062SS-4 - QP183062SS-5	14	QP212486V3S1 - QP212486V4S1	15	QP242486VS-4 - QP242486VS-5	13	QFG	12, 17
P34C	25, 37	QP183062V3S1 - QP183062V4S1	15	QP212486VS-4 - QP212486VS-5	13	QP2424SS - QP2424VS	12	QPL18 - QPL72	16
P34GY	25	QP183062VS-4 - QP183062VS-5	13	QP2124SS - QP2124VS	12	QP243050SS-4 - QP243050SS-5	14	QPL21	16
P34P	20, 25	QP183074SS-4 - QP183074SS-5	14	QP213050SS-4 - QP213050SS-5	14	QP243050VS-4 - QP243050VS-5	13	QPL72	16
P34S	25, 37	QP183074V3S1 - QP183074V4S1	15	QP243062SS-4 - QP243062SS-5	14	QP243062VS-4 - QP243062VS-5	13	QPLH5C - QPLH65C	16
P36C	25	QP183074VS-4 - QP183074VS-5	13	QP243062V3S1 - QP243062V4S1	15	QP243062V3S1 - QP243062V4S1	15	QPLH1-3 - QPLH1-5	16
P39BK	25	QP183086SS-4 - QP183086SS-5	14	QP243062V3S1 - QP243062V4S1	15	QP243062VS-4 - QP243062VS-5	13	QPM243068DR - QPM243068WDR	18, 90
P39C	25, 37	QP183086V3S1 - QP183086V4S1	15	QP213062VS-4 - QP213062VS-5	13	QP243074SS-4 - QP243074SS-5	14	QPM244268DR - QPM244268WDR	18, 90
P42S	25, 37	QP183086VS-4 - QP183086VS-5	13	QP213074SS-4 - QP213074SS-5	14	QP243074V3S1 - QP243074V4S1	15	QPM245468DR - QPM245468WDR	18, 90
P54BK	25	QP1830SS - QP1830VS	12	QP					



WK.....	56	WR63-1824GY - WR63-1872GY-5.....	27	WR74-2424WPM - WR74-2472WPM-5.....	21	WRC-2430-2 - WRC-2472-3.....	88	WRSAD4-54-1824SS - WRSAD4-54-1872SS 40	
WLP-1836C - WLP-3048C.....	99	WR63-1824P - WR63-1872P-5.....	27	WR74-2424WPM - WR74-2472WPM-5.....	21	WRC-2430-2CG - WRC-2472-3CG.....	88	WRSAD4-54-2124SS - WRSAD4-54-2172SS 40	
WLP-DMC.....	99	WR63-1824S - WR63-1872S-5.....	27	WR74-2436SG - WR74-2472SG-5.....	31	WRC-2430-2G - WRC-2472-3G.....	88	WRSAD4-54-2436SS - WRSAD4-54-2472SS 40	
WLP-OSC.....	99	WR63-1836SG - WR63-1872SG-5.....	38	WR74-2436SG-5 - WR74-2472SG-5.....	31	WRC-2430BK-2 - WRC-2472BK-3.....	88	WRSAD4-63-1436SS - WRSAD4-63-1472SS 40	
WMS531 - WMS543.....	112	WR63-1836SG-5 - WR63-1872SG-5.....	39	WR74-2442CRNP - WR74-2442CRNP-5.....	59	WRC-2430GY-2 - WRC-2472GY-3.....	88	WRSAD4-63-1824SS - WRSAD4-63-1872SS 40	
W-PC.....	20, 25, 37	WR63-2124BK - WR63-2172BK-5.....	27	WR74-2448-105106.....	116	WRC-2430P-2 - WRC-2472P-3.....	88	WRSAD4-63-2124SS - WRSAD4-63-2172SS 40	
W-PC-STUD.....	20, 25, 37	WR63-2124C - WR63-2172C-5.....	27	WR74-2448-110105.....	116	WRC3-1836-1265 - WRC3-1836-1887.....	121	WRSAD4-63-2436SS - WRSAD4-63-2472SS 40	
W-PLB.....	20, 25, 37	WR63-2124GY - WR63-2172GY-5.....	27	WR74-2448-66106.....	116	WRC5-63-2436-93060.....	77	WRSAD4-74-1436SS - WRSAD4-74-1472SS 40	
W-PLI.....	20, 25, 37	WR63-2124P - WR63-2172P-5.....	27	WR74-2460-105106.....	116	WRC5-63-2460-93060.....	77	WRSAD4-74-1824SS - WRSAD4-74-1872SS 40	
WR-00CO.....	33	WR63-2124S - WR63-2172S-5.....	27	WR74-2460-88106.....	116	WRC74-BSK1824C-5 - WRC74-BSK2460C-5.....	58	WRSAD4-74-2124SS - WRSAD4-74-2172SS 40	
WR-00H.....	33	WR63-2136SG - WR63-2172SG-5.....	38	WR74-2460-88106.....	116	WRC-C1430GY - WRC-C1836GY.....	83	WRSAD4-74-2436SS - WRSAD4-74-2472SS 40	
WR-00H-5.....	31	WR63-2136SG-5 - WR63-2172SG-5.....	39	WR74-2472-105106.....	116	WRCGR-63-2436 - WRCGR-63-2460.....	82	WRSAD4-86-1436SS - WRSAD4-86-1472SS 40	
WR-00H-HD.....	53	WR63-2424BK - WR63-2472BK-5.....	27	WR74-2472-110106.....	116	WRCP-1830-2 - WRCP-1860-3.....	89	WRSAD4-86-1824SS - WRSAD4-86-1872SS 40	
WR-00HS.....	33	WR63-2424C - WR63-2472C-5.....	27	WR74-2472-176105.....	116	WRCP-1830-2CG - WRCP-1860-3CG.....	89	WRSAD4-86-2124SS - WRSAD4-86-2172SS 40	
WR10-230240.....	95	WR63-2424GY - WR63-2472GY-5.....	27	WR74-3036BK - WR74-3072BK-5.....	28	WRCP-1830-2G - WRCP-1860-3G.....	89	WRSAD4-86-2436SS - WRSAD4-86-2472SS 40	
WR12-101 - WR12-116.....	115	WR63-2424P - WR63-2472P-5.....	27	WR74-3036C - WR74-3072C-5.....	28	WRCP-1830BK-2 - WRCP-1860BK-3.....	89	WRSAD5-54-1436SS - WRSAD5-54-1472SS 41	
WR12-93030.....	125	WR63-2424S - WR63-2472S-5.....	27	WR74-3036GY - WR74-3072GY-5.....	28	WRCP-1830GY-2 - WRCP-1860GY-3.....	89	WRSAD5-54-1824SS - WRSAD5-54-1872SS 41	
WR-3.....	33, 47	WR63-2436SG - WR63-2472SG-5.....	38	WR74-3036P - WR74-3072P-5.....	28	WRCP-1830P-2 - WRCP-1860P-3.....	89	WRSAD5-54-2124SS - WRSAD5-54-2172SS 41	
WR4-12225.....	125	WR63-2436SG-5 - WR63-2472SG-5.....	39	WR74-3036S - WR74-3072S-5.....	28	WRCP-2130-2 - WRCP-2160-3.....	89	WRSAD5-54-2436SS - WRSAD5-54-2472SS 41	
WR4-39-1236-801 - WR4-39-1236-809 120		WR63-3036BK - WR63-3072BK-5.....	27	WR74-3036BK - WR74-3672BK-5.....	28	WRCP-2130-2CG - WRCP-2160-3CG.....	89	WRSAD5-63-1436SS - WRSAD5-63-1472SS 41	
WR5-270.....	95	WR63-3036C - WR63-3072C-5.....	27	WR74-3036C - WR74-3672C-5.....	28	WRCP-2130-2G - WRCP-2160-3G.....	89	WRSAD5-63-1824SS - WRSAD5-63-1872SS 41	
WR5-39-1236-201 - WR5-39-1236-209 118		WR63-3036GY - WR63-3072GY-5.....	27	WR74-3036GY - WR74-3672GY-5.....	28	WRCP-2130GY-2 - WRCP-2160GY-3.....	89	WRSAD5-63-2124SS - WRSAD5-63-2172SS 41	
WR54-1236BK - WR54-1272BK-5.....	26	WR63-3036P - WR63-3072P-5.....	27	WR74-3036P - WR74-3672P-5.....	28	WRCP-2130P-2 - WRCP-2160P-3.....	89	WRSAD5-63-2436SS - WRSAD5-63-2472SS 41	
WR54-1236C - WR54-1272C-5.....	26	WR63-3036S - WR63-3072S-5.....	27	WR74-3036S - WR74-3672S-5.....	28	WRCP-2430-2 - WRCP-2460-3.....	89	WRSAD5-74-1436SS - WRSAD5-74-1472SS 41	
WR54-1236GY - WR54-1272GY-5.....	26	WR63-3636BK - WR63-3672BK-5.....	27	WR74-3036S - WR74-3672S-5.....	28	WRCP-2430-2CG - WRCP-2460-3CG.....	89	WRSAD5-74-1824SS - WRSAD5-74-1872SS 41	
WR54-1236P - WR54-1272P-5.....	26	WR63-3636C - WR63-3672C-5.....	27	WR74-CR2436WPM - WR74-CR2448WPM 22		WRCP-2430-2G - WRCP-2460-3G.....	89	WRSAD5-74-2124SS - WRSAD5-74-2172SS 41	
WR54-1236S - WR54-1272S-5.....	26	WR63-3636GY - WR63-3672GY-5.....	27	WR74-DT2436P - WR74-DT2460P.....	69	WRCP-2430BK-2 - WRCP-2460BK-3.....	89	WRSAD5-74-2436SS - WRSAD5-74-2472SS 41	
WR54-1424BK - WR54-1472BK-5.....	26	WR63-3636P - WR63-3672P-5.....	27	WR7-532.....	113	WRCP-2430GY-2 - WRCP-2460GY-3.....	89	WRSAD5-86-1436SS - WRSAD5-86-1472SS 41	
WR54-1424C - WR54-1472C-5.....	26	WR63-3636S - WR63-3672S-5.....	27	WR7-92080.....	125	WRCP-2430P-2 - WRCP-2460P-3.....	89	WRSAD5-86-1824SS - WRSAD5-86-1872SS 41	
WR54-1424GY - WR54-1472GY-5.....	26	WR6-36-1236-101.....	115	WR7-951.....	103	WRCLP-63-2460.....	82	WRSAD5-86-2124SS - WRSAD5-86-2172SS 41	
WR54-1424P - WR54-1472P-5.....	26	WR6-36-1236-102.....	115	WR8-239 - WR8-255.....	95	WRCS4-63-2436EP - WRCS4-63-2460EP-5 45		WRSAD5-86-2436SS - WRSAD5-86-2472SS 41	
WR54-1430S - WR54-1472S-5.....	26	WR6-36-1236-107.....	115	WR8-423 - WR8-483485.....	101	WRCS4-74-2436EP - WRCS4-74-2460EP-5 45		WR-SB2R2.....	33
WR54-1436SG - WR54-1472SG-5.....	38	WR6-36-1236-109.....	115	WR86-1236BK - WR86-1272BK-5.....	29	WRCSL5-63-1836.....	79	WRSC-1830-2 - WRSC-1872-3.....	88
WR54-1436SG-5 - WR54-1472SG-5.....	39	WR6-953.....	103	WR86-1236C - WR86-1272C-5.....	29	WRCSL5-63-1836-104.....	79	WRSC-1830-2SS - WRSC-1872-3SS.....	88
WR54-1824BK - WR54-1872BK-5.....	26	WR6-954.....	103	WR86-1236GY - WR86-1272GY-5.....	29	WRCSL5-63-1836EP.....	79	WRSC-1830SS-2S - WRSC-1872SS-3S.....	88
WR54-1824C - WR54-1872C-5.....	26	WR6-957.....	103	WR86-1236P - WR86-1272P-5.....	29	WRCSL5-63-1836EP-104.....	79	WRSC-2130-2 - WRSC-2172-3.....	88
WR54-1824GY - WR54-1872GY-5.....	26	WR6-973.....	105	WR86-1236S - WR86-1272S-5.....	29	WRCSL5-63-1848.....	79	WRSC-2130-2G - WRSC-2172-3G.....	88
WR54-1824P - WR54-1872P-5.....	26	WR6-973974.....	105	WR86-1424BK - WR86-1472BK-5.....	29	WRCSL5-63-1848-104.....	79	WRSC-2130SS-2S - WRSC-2172SS-3S.....	88
WR54-1824S - WR54-1872S-5.....	26	WR6-974.....	105	WR86-1424C - WR86-1472C-5.....	29	WRCSL5-63-1848EP.....	79	WRSC-2430-2 - WRSC-2472-3.....	88
WR54-1836SG - WR54-1872SG.....	38	WR7-20-MIX.....	103	WR86-1424GY - WR86-1472GY-5.....	29	WRCSL5-63-1848EP-104.....	79	WRSC-2430-2SS - WRSC-2472-3SS.....	88
WR54-1836SG-5 - WR54-1872SG-5.....	39	WR7-1236BK - WR74-1272BK-5.....	28	WR86-1424P - WR86-1472P-5.....	29	WRCSL5-63-2436.....	79	WRSC-2430SS-2S - WRSC-2472SS-3S.....	88
WR54-2124BK - WR54-2172BK-5.....	26	WR74-1236C - WR74-1272C-5.....	28	WR86-1424WPM - WR86-2472WPM-5.....	21	WRCSL5-63-2436-106.....	79	WRSC4-42-2436FS - WRSC4-42-2460FS.....	88
WR54-2124C - WR54-2172C-5.....	26	WR74-1236GY - WR74-1272GY-5.....	28	WR86-1424WPM - WR86-2472WPM-5.....	21	WRCSL5-63-2436EP.....	79	WRSC4-54-2436FS - WRSC4-54-2460FS.....	88
WR54-2124GY - WR54-2172GY-5.....	26	WR74-1236P - WR74-1272P-5.....	28	WR86-1430S - WR86-1472S-5.....	29	WRCSL5-63-2436EP-106.....	79	WRSCP-1830-2 - WRSCP-1860-3.....	89
WR54-2124P - WR54-2172P-5.....	26	WR74-1236S - WR74-1272S-5.....	28	WR86-1436SG - WR86-1472SG.....	38	WRCSL5-63-2448.....	79	WRSCP-1830-2SS - WRSCP-1860-3SS.....	89
WR54-2124S - WR54-2172S-5.....	26	WR74-1248-101102.....	116	WR86-1436SG-5 - WR86-1472SG-5.....	39	WRCSL5-63-2448-106.....	79	WRSCP-1830SS-2S - WRSCP-1860SS-3S.....	89
WR54-2136SG - WR54-2172SG.....	38	WR74-1248-110101.....	116	WR86-1824BK - WR86-1872BK-5.....	29	WRCSL5-63-2448EP.....	79	WRSCP-2130-2 - WRSCP-2160-3.....	89
WR54-2136SG-5 - WR54-2172SG-5.....	39	WR74-1248-66102.....	116	WR86-1824C - WR86-1872C-5.....	29	WRCSL5-63-2448EP-106.....	79	WRSCP-2130-2SS - WRSCP-2160-3SS.....	89
WR54-2424BK - WR54-2472BK-5.....	26	WR74-1260-101102.....	116	WR86-1824GY - WR86-1872GY-5.....	29	WRCSL5-74-1836-104220.....	79	WRSCP-2130SS-2S - WRSCP-2160SS-3S.....	89
WR54-2424C - WR54-2472C-5.....	26	WR74-1260-143101.....	116	WR86-1824P - WR86-1872P-5.....	29	WRCSL5-74-1836-104230.....	79	WRSCP-2430-2 - WRSCP-2460-3.....	89
WR54-2424GY - WR54-2472GY-5.....	26	WR74-1260-88102.....	116	WR86-1824S - WR86-1872S-5.....	29	WRCSL5-74-1848-104220.....	79	WRSCP-2430-2SS - WRSCP-2460-3SS.....	89
WR54-2424P - WR54-2472P-5.....	26	WR74-1272-101102.....	116	WR86-1836SG - WR86-1872SG.....	38	WRCSL6-74-1848-260.....	78	WRSCP-2430SS-2S - WRSCP-2460SS-3S.....	89
WR54-2424S - WR54-2472S-5.....	26	WR74-1272-110102.....	116	WR86-1836SG-5 - WR86-1872SG-5.....	39	WRCSL6-74-2448-953.....	78	WR-SFP.....	32
WR54-2436SG - WR54-2472SG.....	38	WR74-1272-176101.....	116	WR86-2124BK - WR86-2172BK-5.....	29	WRCSL6-74-2448-953.....	78	WRSL6-74-1848-260.....	78
WR54-2436SG-5 - WR54-2472SG-5.....	39	WR74-1424BK - WR74-1472BK-5.....	28	WR86-2124C - WR86-2172C-5.....	29	WRDBS4-63-2436EP - WRDBS4-63-2460EP-5 45		WRSL6-74-2448-953.....	78
WR54-3036BK - WR54-3072BK-5.....	26	WR74-1424C - WR74-1472C-5.....	28	WR86-2124GY - WR86-2172GY-5.....	29	WRDBS4-74-2436EP - WRDBS4-74-2460EP-5 45		WR-SP.....	23, 32
WR54-3036C - WR54-3072C-5.....	26	WR74-1424GY - WR74-1472GY-5.....	28	WR86-2124P - WR86-2172P-5.....	29	WR-DFP.....	32	WR-SS.....	20, 23, 32
WR54-3036GY - WR54-3072GY-5.....	26	WR74-1424P - WR74-1472P-5.....	28	WR86-2124S - WR86-2172S-5.....	29	WRGR-63-2436 - WRGR-63-2460.....	82	WR-WMB.....	32
WR54-3036P - WR54-3072P-5.....	26	WR74-1424WPM - WR74-1472WPM-5.....	21	WR86-2136SG - WR86-2172SG.....	38	WR-PMGP.....	32	WS-1218DSHC - WS-1848DSHC.....	74, 75, 76
WR54-3036S - WR54-3072S-5.....	26	WR74-1424WPM - WR74-1472WPM-5.....	21	WR86-2136SG-5 - WR86-2172SG-5.....	39	WR-PS.....	33	WS70-DS18AHC - WS70-DS48AHC.....	75
WR54-3636BK - WR54-3672BK-5.....	26	WR74-1430S - WR74-1472S-5.....	29	WR86-2424BK - WR86-2472BK-5.....	29	WR-RG.....	33	WS70-DS18HC.....	75
WR54-3636C - WR54-3672C-5.....	26	WR74-1436SG - WR74-1472SG.....	38	WR86-2424C - WR86-2472C-5.....	29	WR-S24W.....	77	WS70-SS18-43SL.....	74
WR54-3636C - WR54-3672C-5.....	26	WR74-1436SG-5 - WR74-1472SG-5.....	39	WR86-2424GY - WR86-2472GY-5.....	29	WRS4-54-1436SS - WRS4-54-1472SS.....	40	WS70-SS18-74.....	74
WR54-3636GY - WR54-3672GY-5.....	26	WR74-1448WBSK - WR74-1448WBSK.....	80	WR86-2424P - WR86-2472P-5.....	29	WRS4-54-1824SS - WRS4-54-1872SS.....	40	WS70-SS180-43SL.....	74
WR54-3636P - WR54-3672P-5.....	26	WR74-1824BK - WR74-1872BK-5.....	28	WR86-2424S - WR86-2472S-5.....	29	WRS4-54-2436SS - WRS4-54-2472SS.....	40	WS70-SS180-74.....	74
WR54-3636S - WR54-3672S-5.....	26	WR74-1824C - WR74-1872C-5.....	28	WR86-2436SG - WR86-2472SG.....	38	WRS4-63-1436SS - WRS4-63-1472SS.....	40	WS70-SS18AHC.....	75
WR5-533.....	113	WR74-1824GY - WR74-1872GY-5.....	28	WR86-2436SG-5 - WR86-2472SG-5.....	39	WRS4-63-1824SS - WRS4-63-1872SS.....	40	WS70-SS18HC.....	75
WR5-543.....	113	WR74-1824P - WR74-1872P-5.....	28	WR86-3036BK - WR86-3072BK-5.....	29	WRS4-63-2124SS - WRS4-63-2172SS.....	40	WS70-SS36-43SL.....	74
WR5-600.....	111	WR74-1824S - WR74-1872S-5.....	28	WR86-3036C - WR86-3072C-5.....	29	WRS4-63-2436SS - WRS4-63-2472SS.....	40	WS70-SS36-74.....	74
WR5-600800.....	111	WR74-1824WPM - WR74-1872WPM-5.....	21	WR86-3036GY - WR86-3072GY-5.....	29	WRS4-74-1436SS - WRS4-74-1472SS.....	40	WS70-SS36AD-43SL.....	74
WR5-700.....	111	WR74-1824WPM - WR74-1872WPM-5.....	21	WR86-3036P - WR86-3072P-5.....	29	WRS4-74-1824SS - WRS4-74-1872SS.....	40	WS70-SS36AD-74.....	74
WR5-800.....	111	WR74-1836CRNP - WR74-1836CRNP-5.....	51	WR86-3036S - WR86-3072S-5.....	29	WRS4-74-2124SS - WRS4-74-2172SS.....	40	WS70-SS36AHC.....	75
WR5-955.....	103	WR74-1836SG - WR74-1872SG.....	38	WR86-3636BK - WR86-3672BK-5.....	29	WRS4-74-2436SS - WRS4-74-2472SS.....	40	WS70-SS36HC.....	75
WR5-975.....	105	WR74-1836SG-5 - WR74-1872SG-5.....	39	WR86-3636C - WR86-3672C-5.....	29	WRS4-86-1436SS - WRS4-86-1472SS.....	40	WS70-SS48-43SL.....	74
WR5-993.....	106	WR74-1848-103104.....	11						



Millenia Polymer Units



Polymer Wire Units



Mobile To Go Units



Keg Racks



Custom Stations



Polymer Drying Racks

Export Representatives:
MBH International Sales, Inc.
 4907 SW 75th Ave.
 Miami, FL 33155 USA
 Phone: (305) 669-1894
 Fax: (305) 669-1797
sales@mbhny.com
www.mbhny.com